



- ★ Green Device Available
- ★ Super Low Gate Charge
- ★ Excellent Cdv/dt effect decline
- ★ Advanced high cell density Trench technology

CST1002C Product Summary



BVDSS	RDSON	ID
100V	220mΩ	2.2 A

CST1002C Description

The CST1002C is the high cell density trenched N-ch MOSFETs, which provides excellent RDSON and efficiency for most of the small power switching and load switch applications. The CST1002C meet the RoHS and Green Product requirement with full function reliability approved.

CST1002C SOT23 Pin Configuration

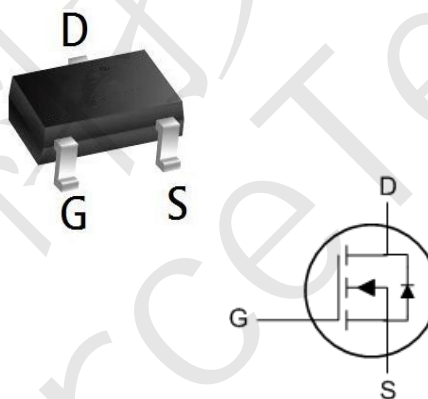

CST1002C Absolute Maximum Ratings (T_A=25°C unless otherwise specified)

Symbol	Parameter	Max.	Units	
V _{DSS}	Drain-Source Voltage	100	V	
V _{GSS}	Gate-Source Voltage	±20	V	
I _D	Continuous Drain Current	T _A = 25°C	2.2	A
		T _A = 100°C	1.4	A
I _{DM}	Pulsed Drain Current ^{note1}	8.8	A	
P _D	Power Dissipation	2.3	W	
R _{θJA}	Thermal Resistance, Junction to Ambient	54	°C/W	
T _J , T _{STG}	Operating and Storage Temperature Range	-55 to +150	°C	



CST1002C N-Ch 100V Fast Switching MOSFETs

CST1002C Electrical Characteristics (T_J=25°C unless otherwise specified)

Symbol	Parameter	Test Condition	Min.	Typ.	Max.	Units
Off Characteristic						
V _{(BR)DSS}	Drain-Source Breakdown Voltage	V _{GS} =0V, I _D =250μA	100	-	-	V
I _{DSS}	Zero Gate Voltage Drain Current	V _{DS} =100V, V _{GS} =0V	-	-	1.0	μA
I _{GSS}	Gate to Body Leakage Current	V _{DS} =0V, V _{GS} =±20V	-	-	±100	nA
On Characteristics						
V _{GS(th)}	Gate Threshold Voltage	V _{DS} =V _{GS} , I _D =250μA	1.0	1.5	2.2	V
R _{DS(on)}	Static Drain-Source on-Resistance note2	V _{GS} =10V, I _D =2A	-	220	286	mΩ
		V _{GS} =4.5V, I _D =1A	-	223	312	
Dynamic Characteristics						
C _{iss}	Input Capacitance	V _{DS} =25V, V _{GS} =0V, f=1.0MHz	-	321	-	pF
C _{oss}	Output Capacitance		-	21	-	pF
C _{rss}	Reverse Transfer Capacitance		-	15	-	pF
Q _g	Total Gate Charge	V _{DS} =30V, I _D =2A, V _{GS} =10V	-	5.3	-	nC
Q _{gs}	Gate-Source Charge		-	1.3	-	nC
Q _{gd}	Gate-Drain("Miller") Charge		-	1.7	-	nC
Switching Characteristics						
t _{d(on)}	Turn-on Delay Time	V _{DS} =30V, I _D =1A, R _{GEN} =3Ω, V _{GS} =10V	-	14	-	ns
t _r	Turn-on Rise Time		-	54	-	ns
t _{d(off)}	Turn-off Delay Time		-	18	-	ns
t _f	Turn-off Fall Time		-	11	-	ns
Drain-Source Diode Characteristics and Maximum Ratings						
I _S	Maximum Continuous Drain to Source Diode Forward Current		-	-	2.2	A
I _{SM}	Maximum Pulsed Drain to Source Diode Forward Current		-	-	8.8	A
V _{SD}	Drain to Source Diode Forward Voltage	V _{GS} =0V, I _S =2.2A	-	-	1.2	V

Notes: 1. Repetitive Rating: Pulse Width Limited by Maximum Junction Temperature

2. Pulse Test: Pulse Width≤300μs, Duty Cycle≤0.5%



CST1002C Typical Performance Characteristics

Figure 1: Output Characteristics

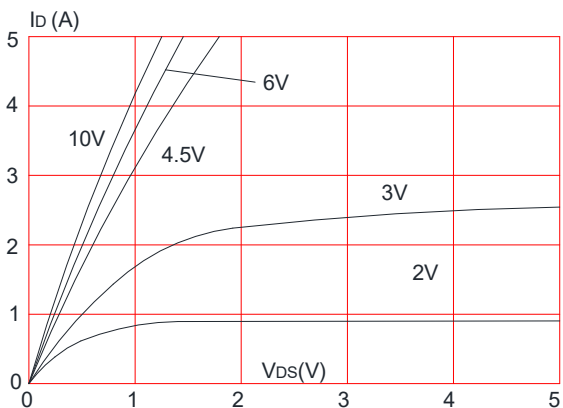

Figure 2: Typical Transfer Characteristics

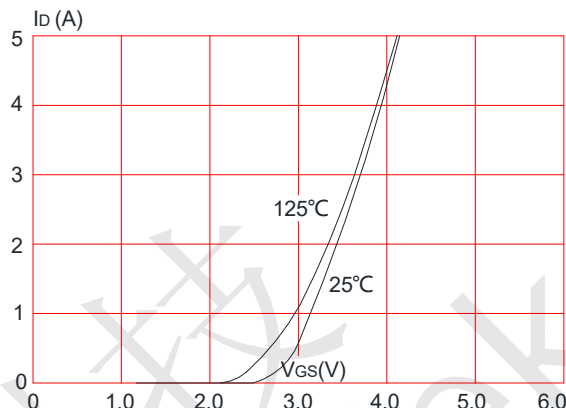

Figure 3: On-resistance vs. Drain Current

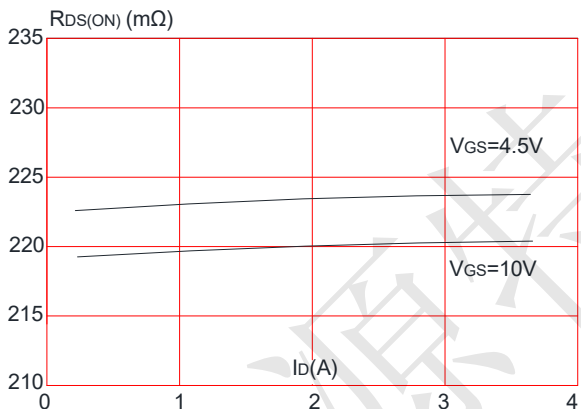

Figure 4: Body Diode Characteristics

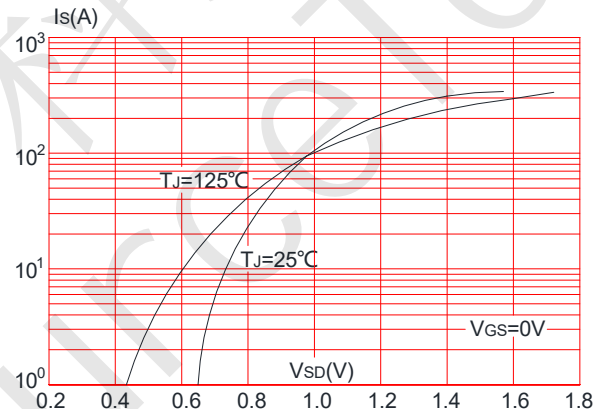

Figure 5: Gate Charge Characteristics

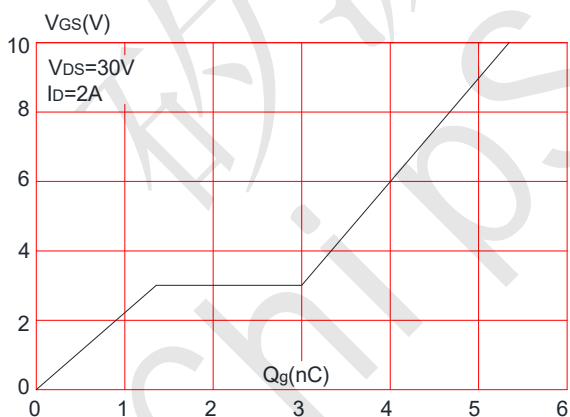
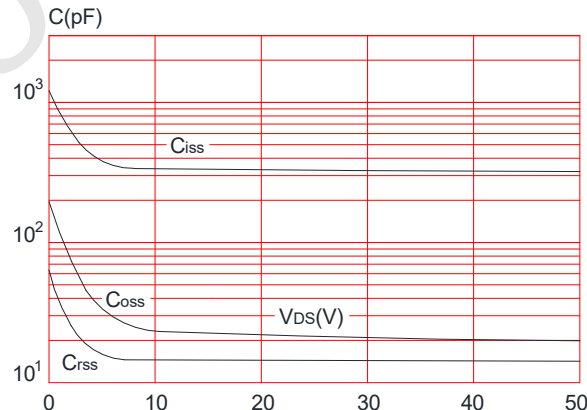

Figure 6: Capacitance Characteristics





CST1002C N-Ch 100V Fast Switching MOSFETs

Figure 7: Normalized Breakdown Voltage vs. Junction Temperature

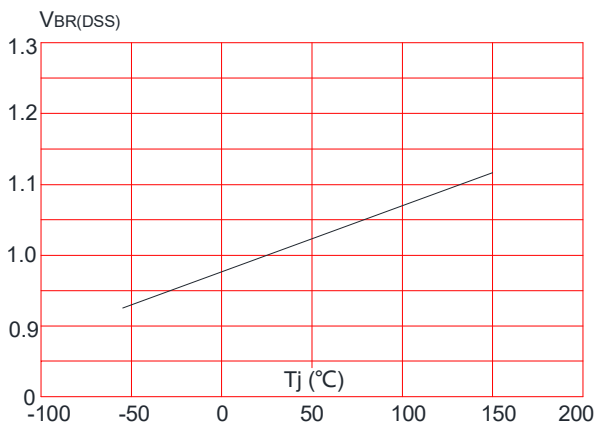

Figure 8: Normalized on Resistance vs. Junction Temperature

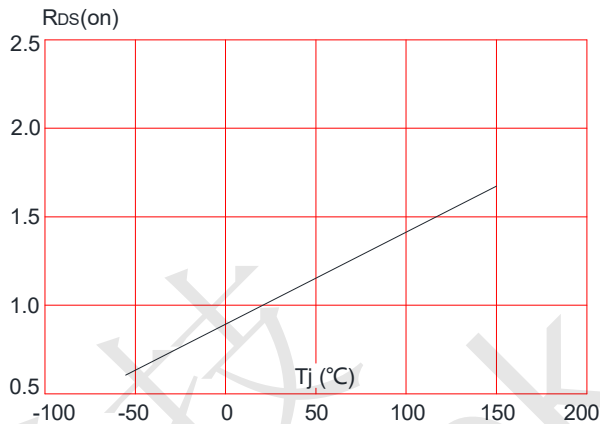

Figure 9: Maximum Safe Operating Area

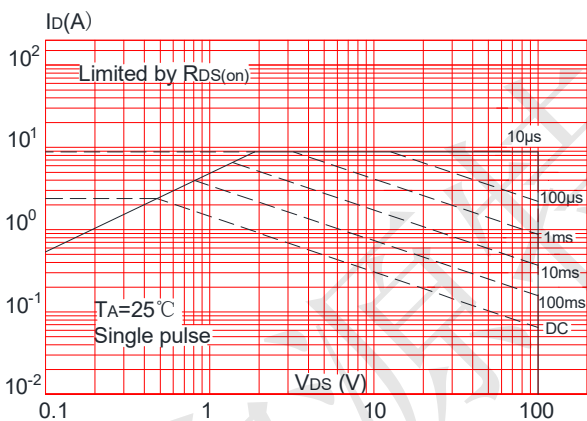

Figure 10: Maximum Continuous Drain Current vs. Ambient Temperature

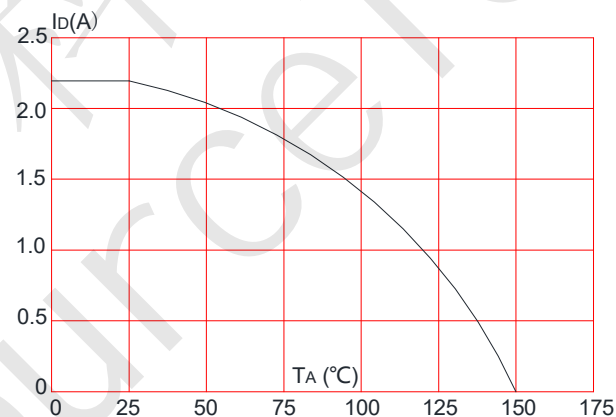
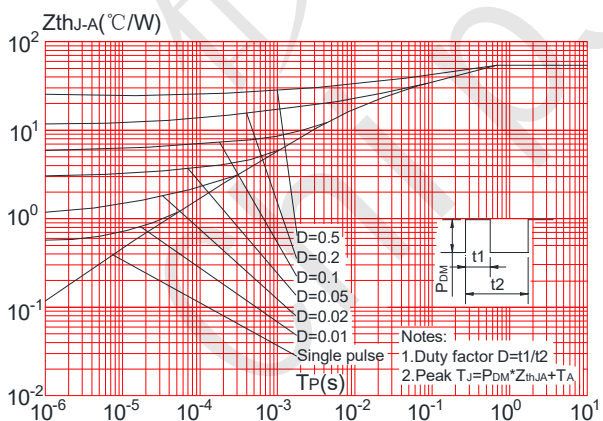

Figure.11: Maximum Effective Transient Thermal Impedance, Junction-to-Ambient





CST1002C Test Circuit

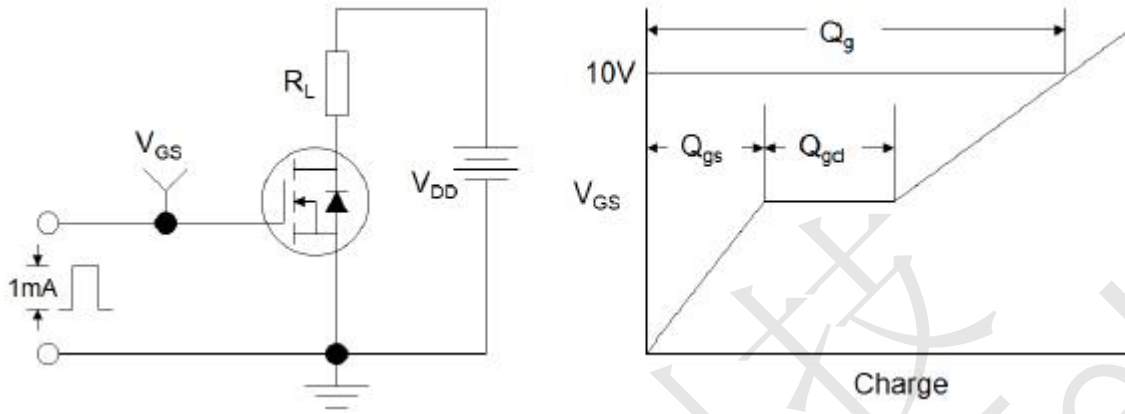

Figure1:Gate Charge Test Circuit & Waveform

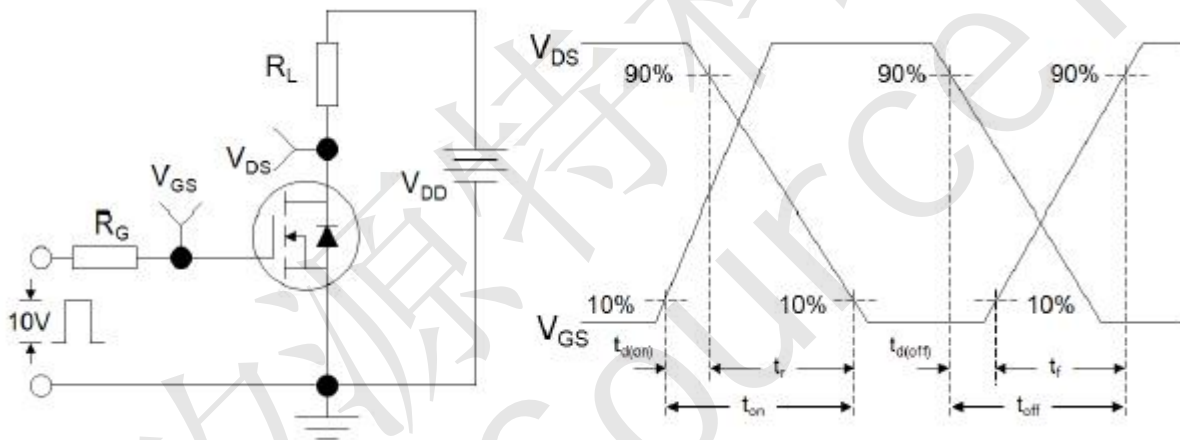

Figure 2: Resistive Switching Test Circuit & Waveforms

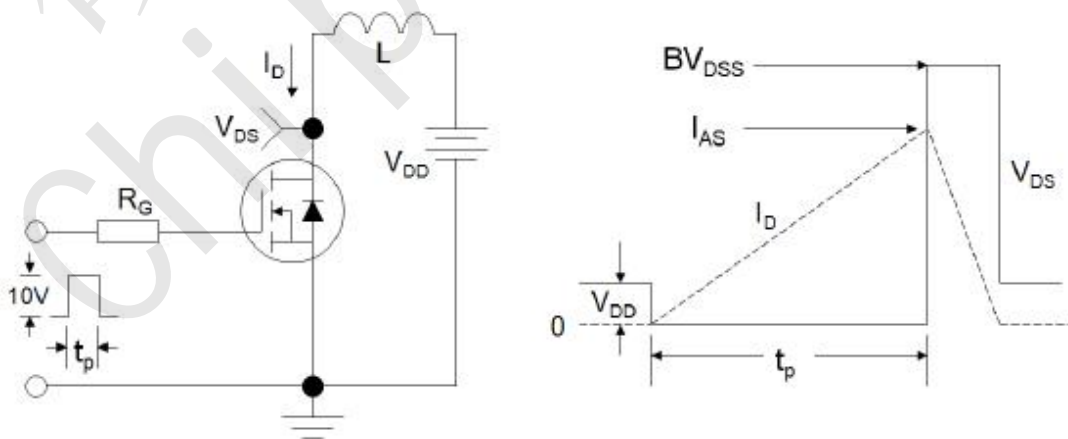
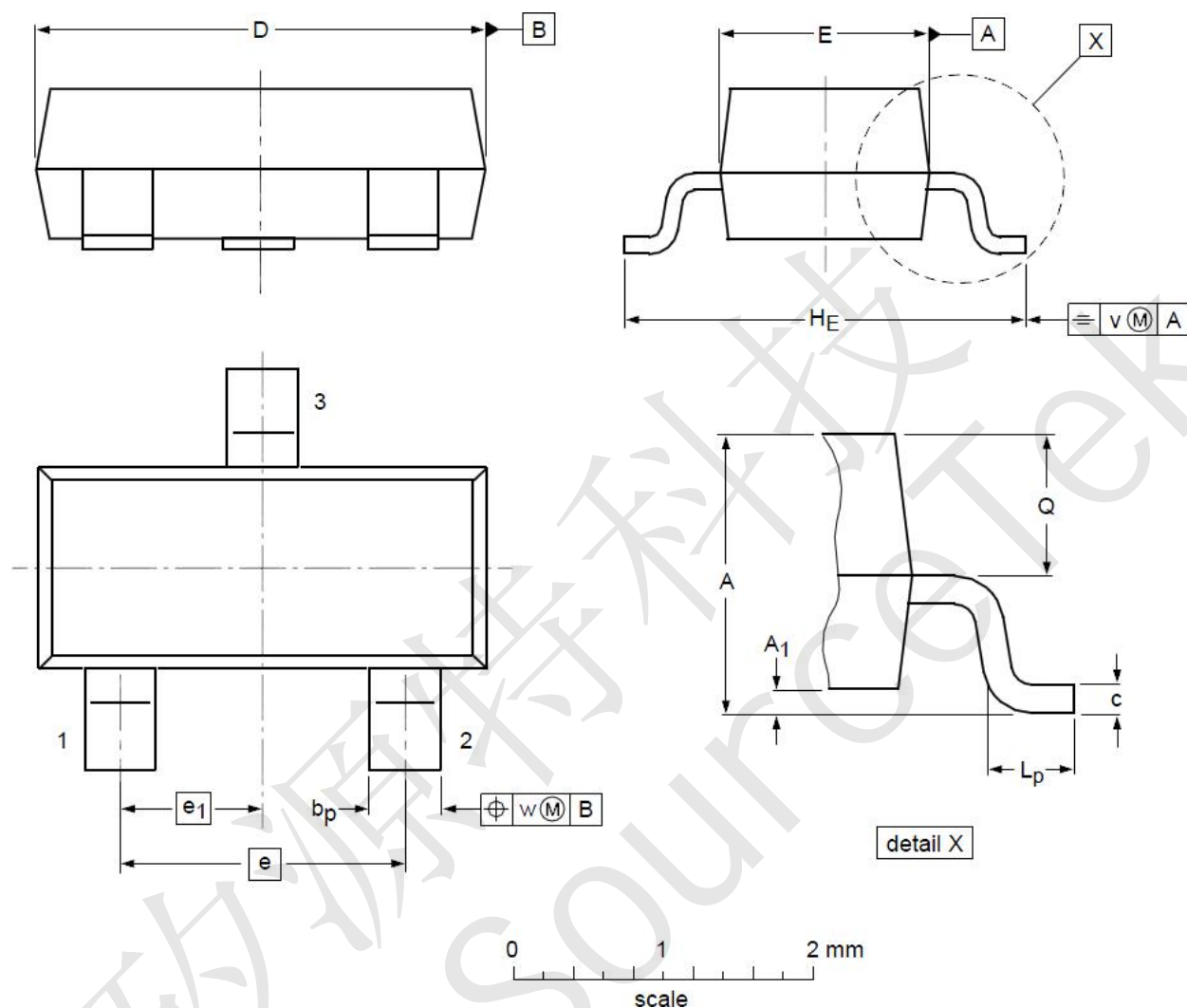

Figure 3:Unclamped Inductive Switching Test Circuit & Waveforms



CST1002C SOT23 Mechanical Data



DIMENSIONS (unit : mm)

Symbol	Min	Typ	Max	Symbol	Min	Typ	Max
A	0.90	1.01	1.15	A ₁	0.01	0.05	0.10
b _p	0.30	0.42	0.50	c	0.08	0.13	0.15
D	2.80	2.92	3.00	E	1.20	1.33	1.40
e	--	1.90	--	e ₁	--	0.95	--
H _E	2.25	2.40	2.55	L _p	0.30	0.42	0.50
Q	0.45	0.49	0.55	v	--	0.20	--
w	--	0.10	--				