



CST10G04S N-Ch and P-Ch Fast Switching MOSFETs

- ★ Green Device Available
- ★ Super Low Gate Charge
- ★ Excellent CdV/dt effect decline
- ★ Advanced high cell density Trench technology

CST10G04S Product Summary



BVDSS	RDSON	ID
40V	17mΩ	10A
-40V	34mΩ	-10A

CST10G04S Description

The CST10G04S is the high performance complementary N-ch and P-ch MOSFETs with high cell density, which provide excellent RDSON and gate charge for most of the synchronous buck converter applications. The CST10G04S meet the RoHS and Green Product requirement with full function reliability approved.

CST10G04S SOP8 Pin Configurations

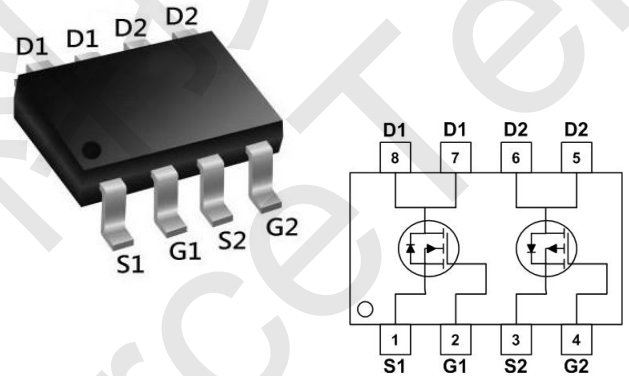

CST10G04S Absolute Maximum Ratings (T_A=25°C unless otherwise specified)

Symbol	Parameter	Max. N-Channel	Max. P-Channel	Units	
V _{DSS}	Drain-Source Voltage	40	-40	V	
V _{GSS}	Gate-Source Voltage	±20	±20	V	
I _D	Continuous Drain Current	T _A = 25°C	10	-10	A
		T _A = 100°C	6.5	-6.5	A
I _{DM}	Pulsed Drain Current ^{note1}	40	-40	A	
E _{AS}	Single Pulsed Avalanche Energy ^{note2}	19	27.5	mJ	
P _D	Power Dissipation	T _A = 25°C	3.4	7.5	W
R _{θJA}	Thermal Resistance, Junction to Ambient	36.8	16.7	°C/W	
T _J , T _{STG}	Operating and Storage Temperature Range	-55 to +150		°C	



CST10G04S N-Ch and P-Ch Fast Switching MOSFETs

CST10G04S N-Channel Electrical Characteristics ($T_J=25^\circ\text{C}$ unless otherwise specified)

Symbol	Parameter	Test Condition	Min.	Typ.	Max.	Units
Off Characteristic						
$V_{(BR)DSS}$	Drain-Source Breakdown Voltage	$V_{GS}=0V, I_D=250\mu A$	40	-	-	V
I_{DSS}	Zero Gate Voltage Drain Current	$V_{DS}=40V, V_{GS}=0V$	-	-	1.0	μA
I_{GSS}	Gate to Body Leakage Current	$V_{DS}=0V, V_{GS}=\pm 20V$	-	-	± 100	nA
On Characteristics						
$V_{GS(th)}$	Gate Threshold Voltage	$V_{DS}=V_{GS}, I_D=250\mu A$	1.0	1.5	2.5	V
$R_{DS(on)}$	Static Drain-Source on-Resistance <small>note3</small>	$V_{GS}=10V, I_D=10A$	-	17	20	m Ω
		$V_{GS}=4.5V, I_D=5A$	-	22	27	m Ω
Dynamic Characteristics						
C_{iss}	Input Capacitance	$V_{DS}=20V, V_{GS}=0V,$ $f=1.0MHz$	-	980	-	pF
C_{oss}	Output Capacitance		-	86.2	-	pF
C_{rss}	Reverse Transfer Capacitance		-	68.5	-	pF
Q_g	Total Gate Charge	$V_{DS}=20V, I_D=5A,$ $V_{GS}=10V$	-	11	-	nC
Q_{gs}	Gate-Source Charge		-	1.9	-	nC
Q_{gd}	Gate-Drain("Miller") Charge		-	2.2	-	nC
Switching Characteristics						
$t_{d(on)}$	Turn-on Delay Time	$V_{DS}=20V, I_D=5A,$ $R_L=2.5\Omega, R_{REN}=3\Omega$	-	11	-	ns
t_r	Turn-on Rise Time		-	13	-	ns
$t_{d(off)}$	Turn-off Delay Time		-	36	-	ns
t_f	Turn-off Fall Time		-	9	-	ns
Drain-Source Diode Characteristics and Maximum Ratings						
I_S	Maximum Continuous Drain to Source Diode Forward Current		-	-	10	A
I_{SM}	Maximum Pulsed Drain to Source Diode Forward Current		-	-	40	A
V_{SD}	Drain to Source Diode Forward Voltage	$V_{GS}=0V, I_S=10A$	-	-0.8	-1.2	V
t_{rr}	Body Diode Reverse Recovery Time	$T_J=25^\circ\text{C},$ $I_F=10A, di/dt=100A/\mu s$	-	19	-	ns
Q_{rr}	Body Diode Reverse Recovery		-	11	-	nC

Notes: 1. Repetitive Rating: Pulse Width Limited by Maximum Junction Temperature

2. EAS condition : $T_J=25^\circ\text{C}, V_{DD}=30V, V_G=10V, L=0.5mH, R_g=25\Omega, I_{AS}=8.7A$

$T_J=25^\circ\text{C}, V_{DD}=-30V, V_G=-10V, L=0.5mH, R_g=25\Omega, I_{AS}=-10.5A$

3. Pulse Test: Pulse Width $\leq 300\mu s$, Duty Cycle $\leq 2\%$



CST10G04S N-Ch and P-Ch Fast Switching MOSFETs

CST10G04S P-Channel Electrical Characteristics (T_J=25°C unless otherwise specified)

Symbol	Parameter	Test Condition	Min.	Typ.	Max.	Units
Off Characteristic						
V _{(BR)DSS}	Drain-Source Breakdown Voltage	V _{GS} =0V, I _D = -250μA	-40	-	-	V
I _{DSS}	Zero Gate Voltage Drain Current	V _{DS} = -40V, V _{GS} =0V	-	-	-1	μA
I _{GSS}	Gate to Body Leakage Current	V _{DS} =0V, V _{GS} =±20V	-	-	±100	nA
On Characteristics						
V _{GS(th)}	Gate Threshold Voltage	V _{DS} =V _{GS} , I _D = -250μA	-1.0	-1.6	-2.5	V
R _{DS(on)}	Static Drain-Source on-Resistance note3	V _{GS} = -10V, I _D = -8A	-	34	44	mΩ
		V _{GS} = -4.5V, I _D = -5A	-	46	62	
Dynamic Characteristics						
C _{iss}	Input Capacitance	V _{DS} = -20V, V _{GS} =0V, f=1.0MHz	-	1034	-	pF
C _{oss}	Output Capacitance		-	107	-	pF
C _{rss}	Reverse Transfer Capacitance		-	79.5	-	pF
Q _g	Total Gate Charge	V _{DS} = -20V, I _D = -5A, V _{GS} = -10V	-	20	-	nC
Q _{gs}	Gate-Source Charge		-	3.5	-	nC
Q _{gd}	Gate-Drain("Miller") Charge		-	4.2	-	nC
Switching Characteristics						
t _{d(on)}	Turn-on Delay Time	V _{DD} = -20V, I _D = -5A, V _{GS} = -10V, R _{GEN} =2.5Ω	-	8	-	ns
t _r	Turn-on Rise Time		-	15	-	ns
t _{d(off)}	Turn-off Delay Time		-	23	-	ns
t _f	Turn-off Fall Time		-	9	-	ns
Drain-Source Diode Characteristics and Maximum Ratings						
I _S	Maximum Continuous Drain to Source Diode Forward Current		-	-	-10	A
I _{SM}	Maximum Pulsed Drain to Source Diode Forward Current		-	-	-40	A
V _{SD}	Drain to Source Diode Forward Voltage	V _{GS} =0V, I _S = -10A	-	-0.8	-1.2	V
trr	Reverse Recovery Time	T _J =25 °C	-	29	-	ns
Qrr	Reverse Recovery Charge	I _F =10A, di/dt=100A/μs	-	20	-	nC



CST10G04S Typical Performance Characteristics-N

Figure 1: Output Characteristics

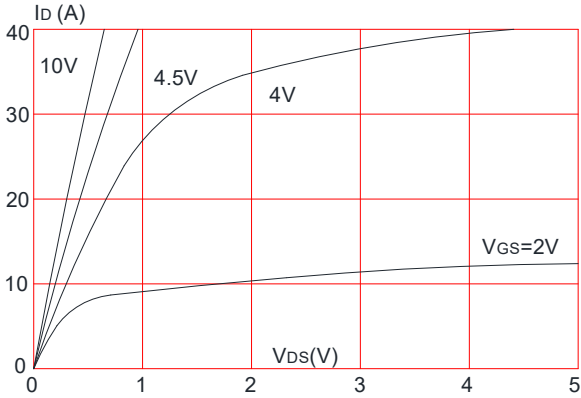

Figure 2: Typical Transfer Characteristics

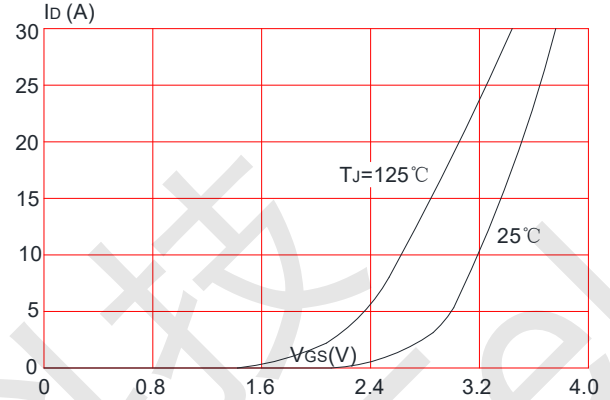

Figure 3: On-resistance vs. Drain Current

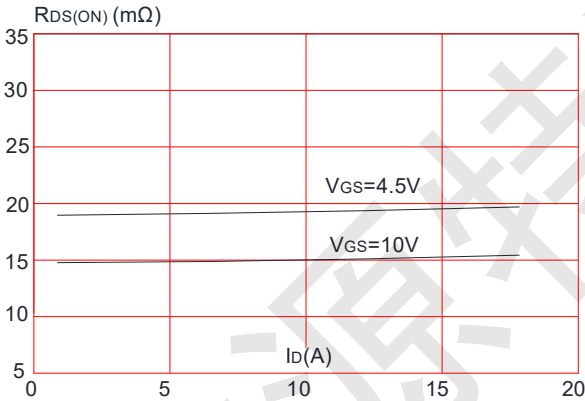

Figure 4: Body Diode Characteristics

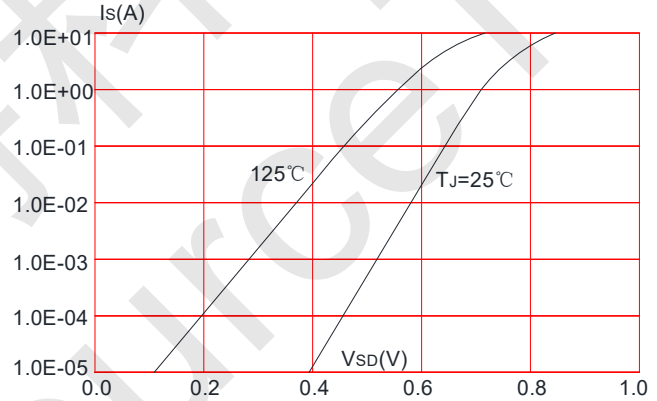

Figure 5: Gate Charge Characteristics

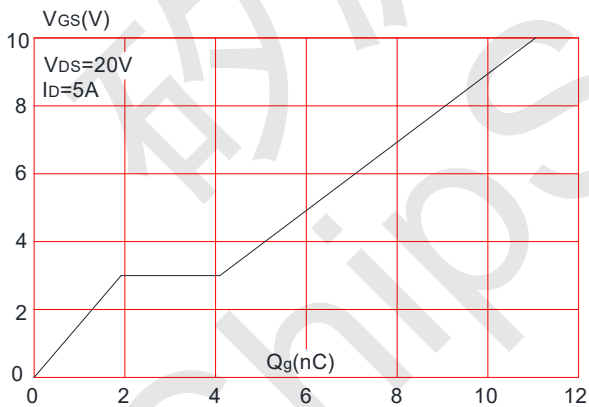
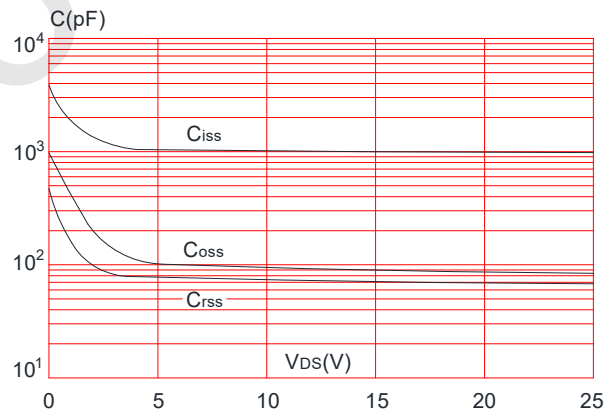

Figure 6: Capacitance Characteristics





CST10G04S N-Ch and P-Ch Fast Switching MOSFETs

Figure 7: Normalized Breakdown Voltage vs. Junction Temperature

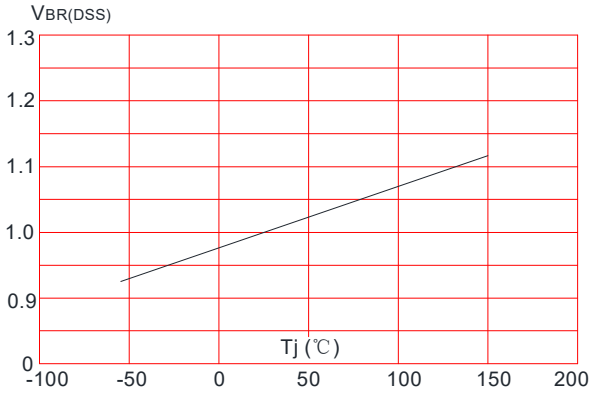

Figure 8: Normalized on Resistance vs. Junction Temperature

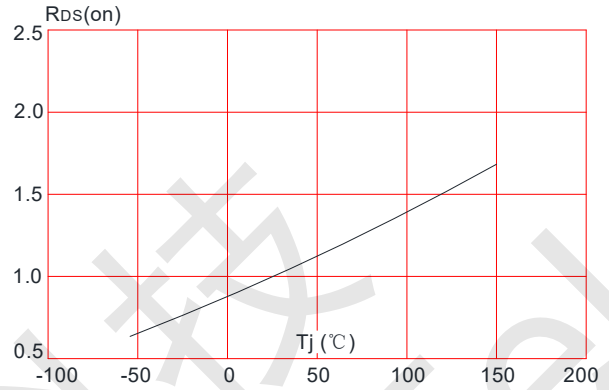

Figure 9: Maximum Safe Operating Area

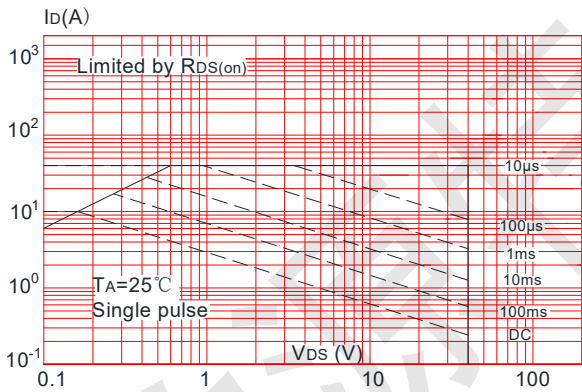

Figure 10: Maximum Continuous Drain Current vs. Ambient Temperature

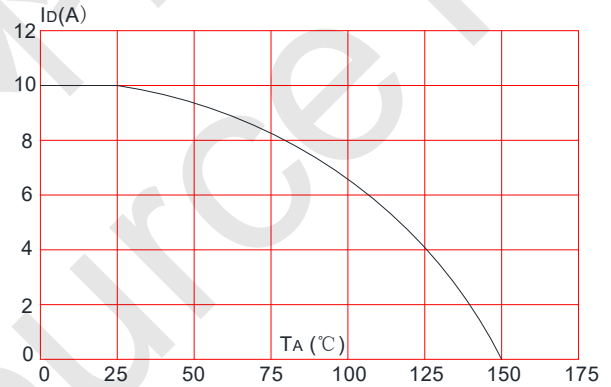
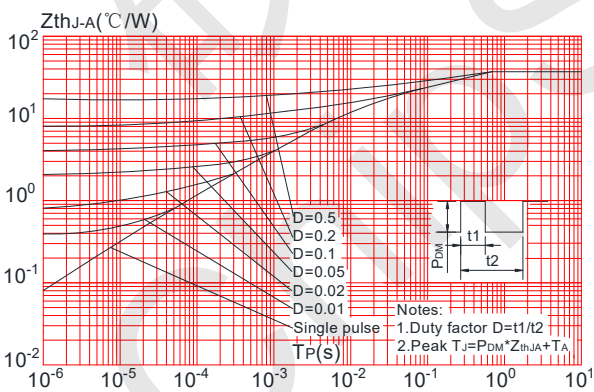

Figure.11: Maximum Effective Transient Thermal Impedance, Junction-to-Ambient





CST10G04S Test Circuit-N

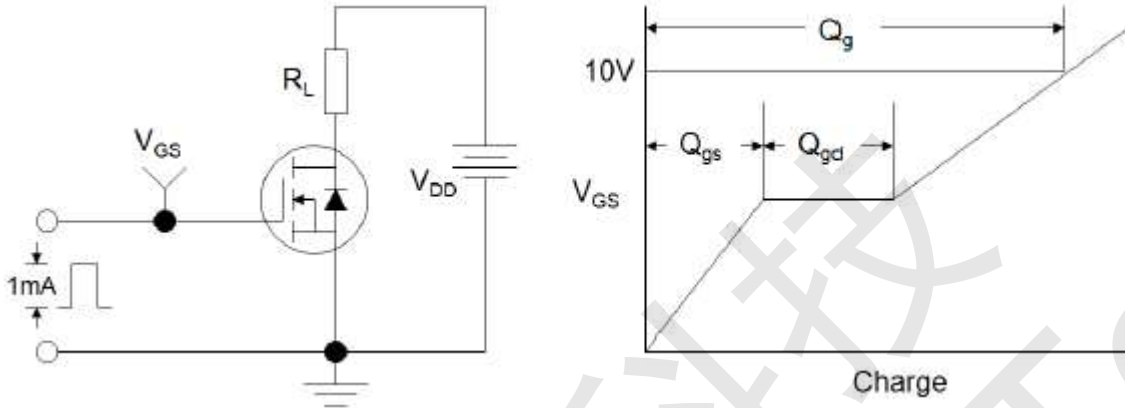

Figure1:Gate Charge Test Circuit & Waveform

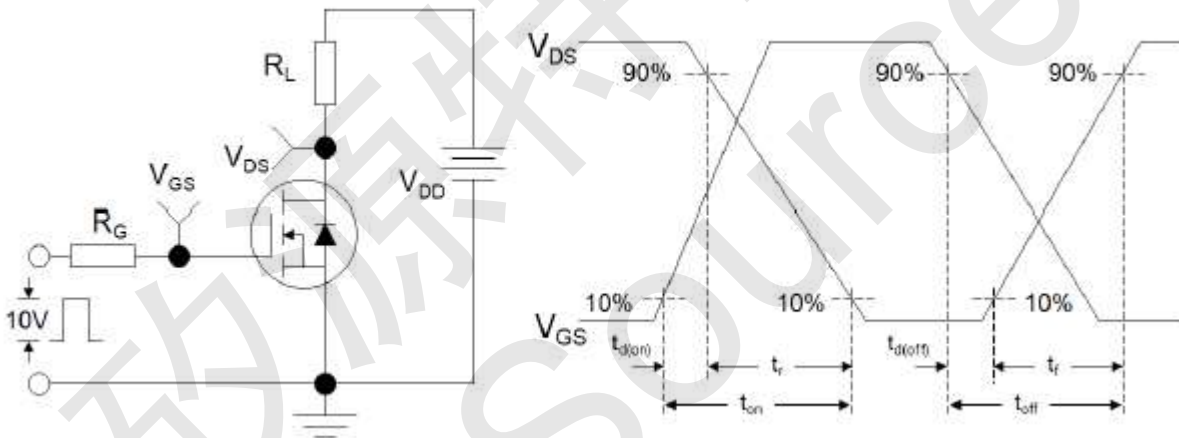

Figure 2: Resistive Switching Test Circuit & Waveforms

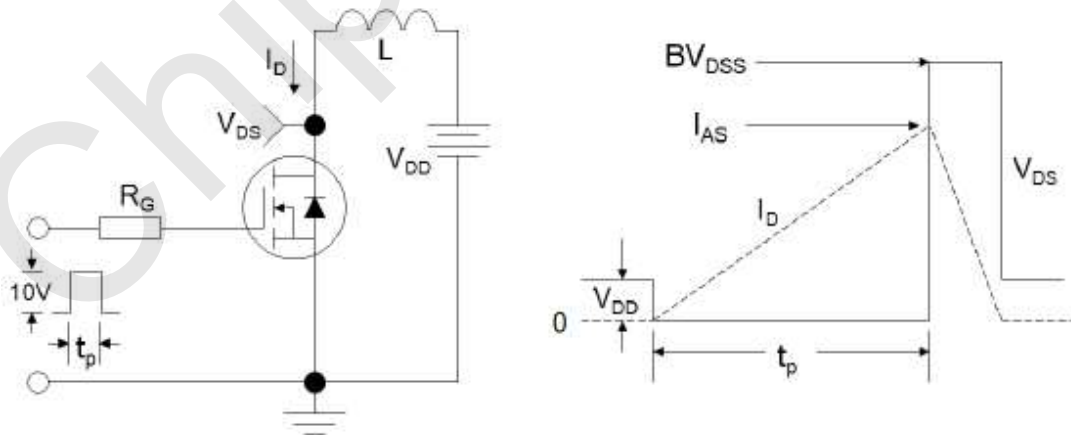

Figure 3:Unclamped Inductive Switching Test Circuit & Waveforms



CST10G04S Typical Performance Characteristics-P

Figure 1: Output Characteristics

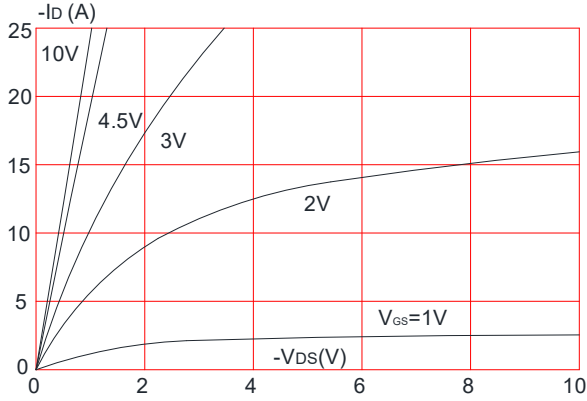

Figure 2: Typical Transfer Characteristics

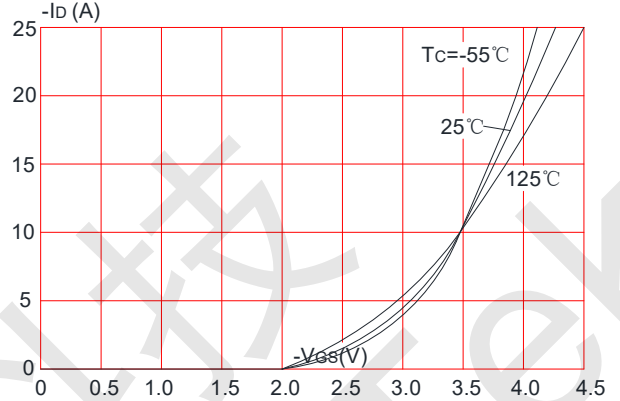

Figure 3: On-resistance vs. Drain Current

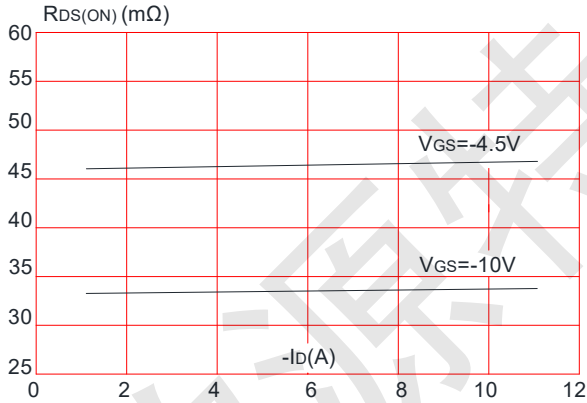

Figure 4: Body Diode Characteristics

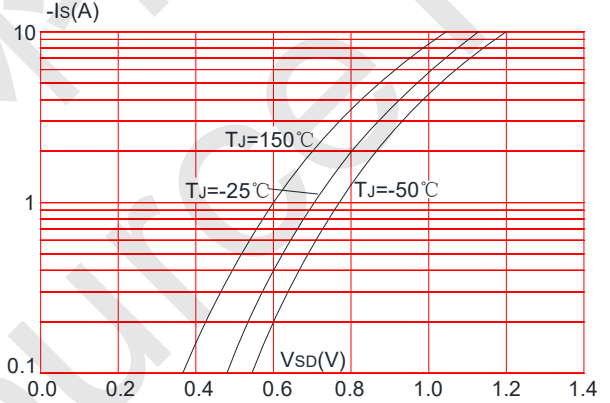

Figure 5: Gate Charge Characteristics

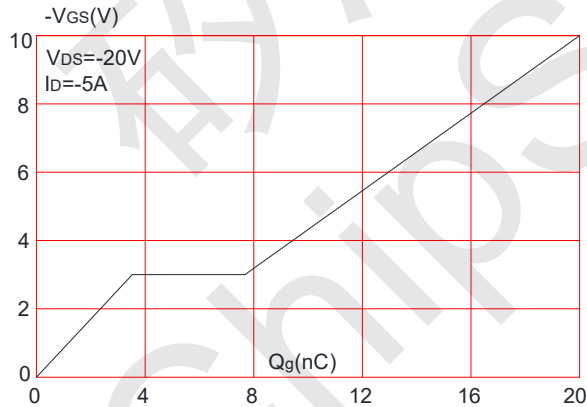
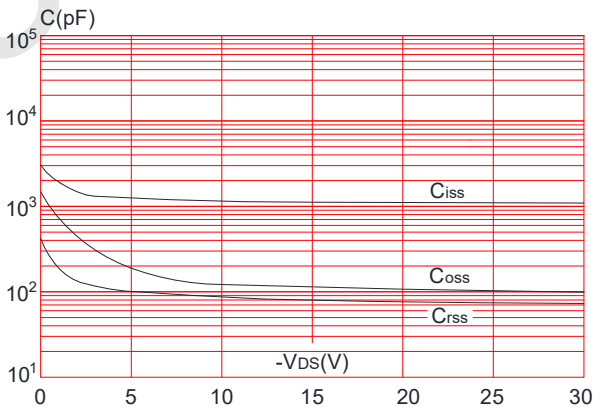

Figure 6: Capacitance Characteristics





CST10G04S N-Ch and P-Ch Fast Switching MOSFETs

Figure 7: Normalized Breakdown Voltage vs. Junction Temperature

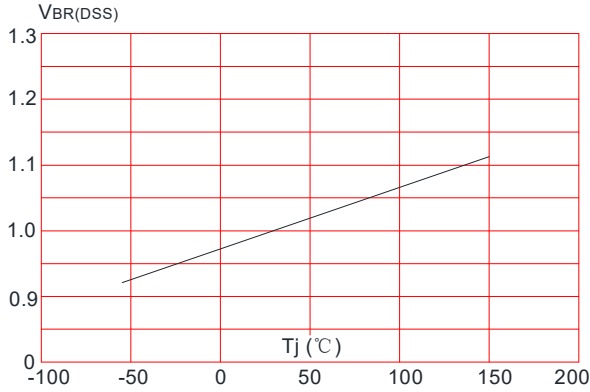

Figure 8: Normalized on Resistance vs. Junction Temperature

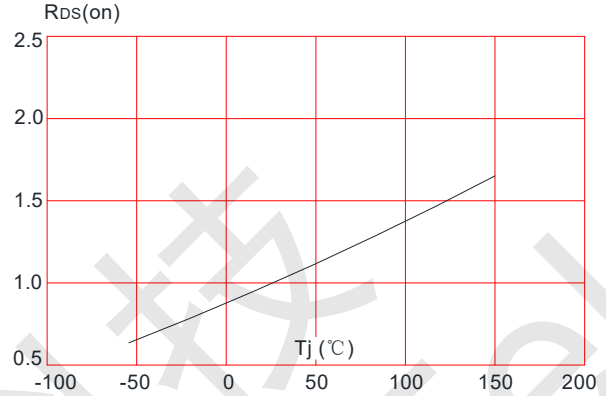

Figure 9: Maximum Safe Operating Area

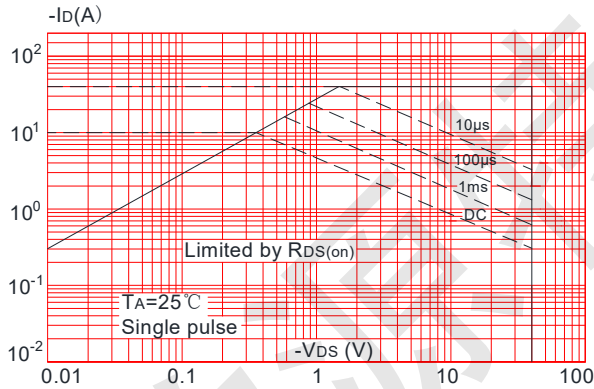

Figure 10: Maximum Continuous Drain Current vs. Ambient Temperature

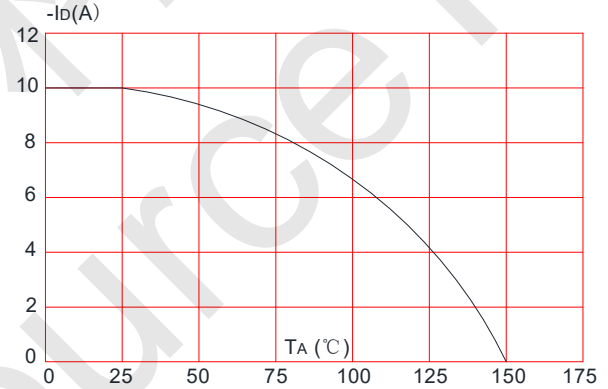
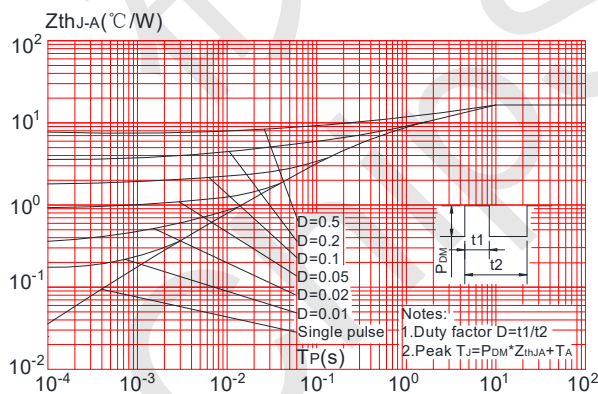

Figure.11: Maximum Effective Transient Thermal Impedance, Junction-to-Ambient





CST10G04S Test Circuit-P

Gate Charge Test Circuit & Waveform

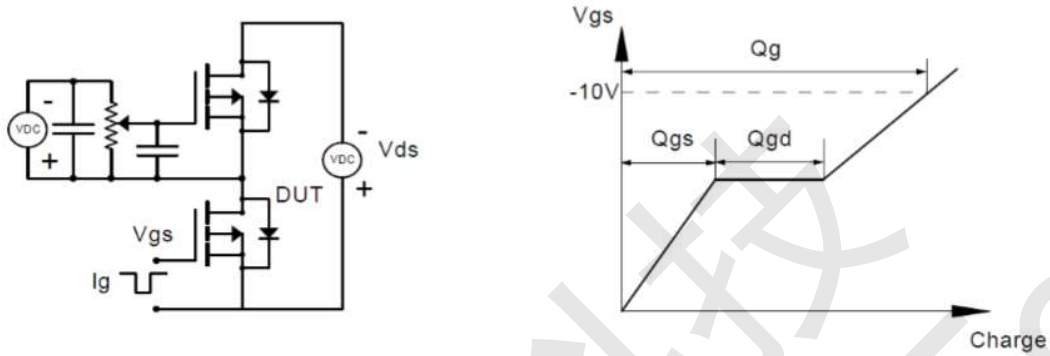

Resistive Switching Test Circuit & Waveforms

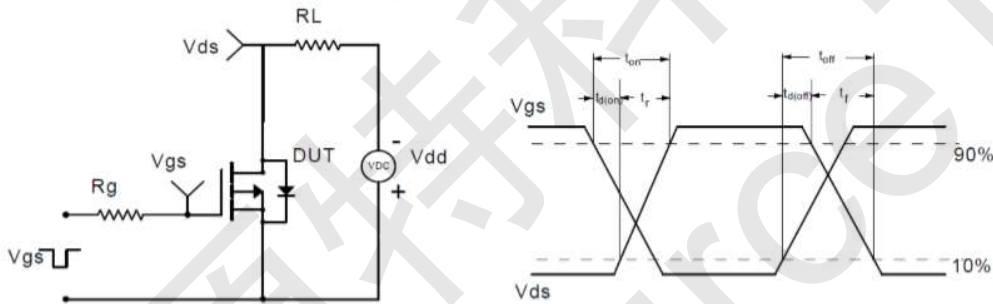

Unclamped Inductive Switching (UIS) Test Circuit & Waveforms

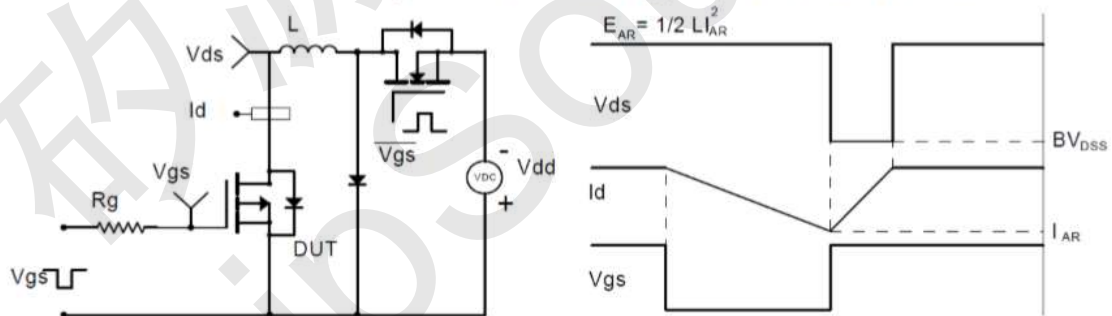

Diode Recovery Test Circuit & Waveforms

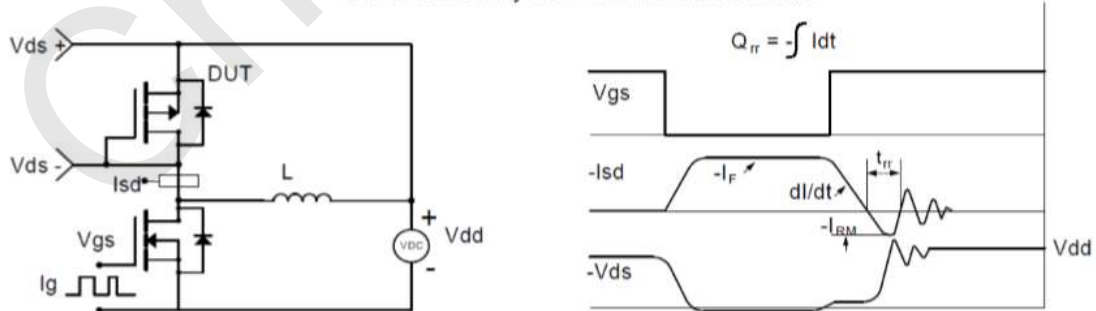



CST10G04S Package Mechanical Data- SOP-8

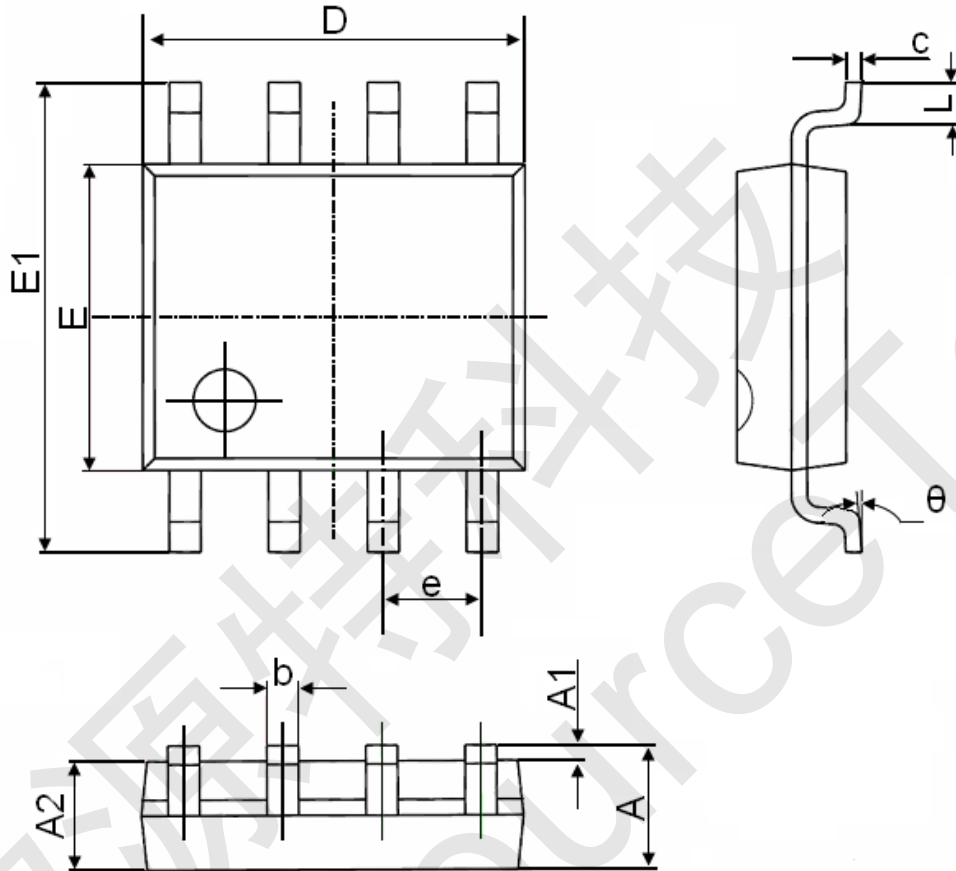

Symbol	Dimensions In Millimeters		Dimensions In Inches	
	Min.	Max.	Min.	Max.
A	1.350	1.750	0.053	0.069
A1	0.100	0.250	0.004	0.010
A2	1.350	1.550	0.053	0.061
b	0.330	0.510	0.013	0.020
c	0.170	0.250	0.006	0.010
D	4.700	5.100	0.185	0.200
E	3.800	4.000	0.150	0.157
E1	5.800	6.200	0.228	0.244
e	1.270(BSC)		0.050(BSC)	
L	0.400	1.270	0.016	0.050
θ	0°	8°	0°	8°