



CST120N03 N-Ch 30V Fast Switching MOSFETs

- ★ Super Low Gate Charge
- ★ 100% EAS Guaranteed
- ★ Green Device Available
- ★ Excellent CdV/dt effect decline
- ★ Advanced high cell density Trench technology



CST120N03 Product Summary

BVDSS	RDSON	ID
30V	3.0mΩ	120 A

CST120N03 Description

The CST120N03 is the high cell density trenched N-ch MOSFETs, which provide excellent RDSON and gate charge for most of the synchronous buck converter applications.

The CST120N03 meet the RoHS and Green Product requirement, 100% EAS guaranteed with full function reliability approved.

CST120N03 TO252 Pin Configuration

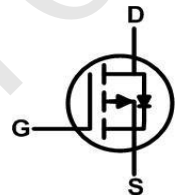
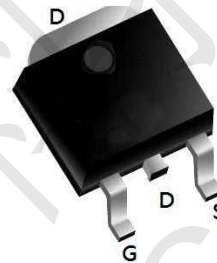

CST120N03 Absolute Maximum Ratings

Symbol	Parameter	Rating		Units
		10s	Steady State	
V_{DS}	Drain-Source Voltage	30		V
V_{GS}	Gate-Source Voltage	± 20		V
$I_D@T_C=25^\circ C$	Continuous Drain Current, $V_{GS} @ 10V^1$	120		A
$I_D@T_C=100^\circ C$	Continuous Drain Current, $V_{GS} @ 10V^1$	75		A
I_{DM}	Pulsed Drain Current ²	384		A
EAS	Single Pulse Avalanche Energy ³	198		mJ
I_{AS}	Avalanche Current	53.8		A
$P_D@T_C=25^\circ C$	Total Power Dissipation ⁴	62.5		W
$P_D@T_A=25^\circ C$	Total Power Dissipation ⁴	6	2.42	W
T_{STG}	Storage Temperature Range	-55 to 175		$^\circ C$
T_J	Operating Junction Temperature Range	-55 to 175		$^\circ C$

CST120N03 Thermal Data

Symbol	Parameter	Typ.	Max.	Unit
$R_{\theta JA}$	Thermal Resistance Junction-Ambient ¹	---	62	$^\circ C/W$
$R_{\theta JA}$	Thermal Resistance Junction-Ambient ¹ (t ≤ 10s)	---	25	$^\circ C/W$
$R_{\theta JC}$	Thermal Resistance Junction-Case ¹	---	2.4	$^\circ C/W$



CST120N03 Electrical Characteristics (T_J=25 °C, unless otherwise noted)

Symbol	Parameter	Test Conditions	Min.	Typ.	Max.	Unit
Static Characteristics						
BV _{DSS}	Drain-Source Breakdown Voltage	V _{GS} =0V, I _{DS} =250μA	30	-	-	V
I _{DSS}	Zero Gate Voltage Drain Current	V _{DS} =24V, V _{GS} =0V T _J =85°C	-	-	1 30	μA
V _{GS(th)}	Gate Threshold Voltage	V _{DS} =V _{GS} , I _{DS} =250μA	1.4	1.7	2.5	V
I _{GSS}	Gate Leakage Current	V _{GS} =±20V, V _{DS} =0V	-	-	±100	nA
R _{DS(ON)} ^d	Drain-Source On-state Resistance	V _{GS} =10V, I _{DS} =20A T _J =125°C	-	3 4.4	3.8	mΩ
Gfs	Forward Transconductance	V _{DS} =5V, I _{DS} =10A	-	24.6	-	S
Diode Characteristics						
V _{SD} ^d	Diode Forward Voltage	I _{SD} =20A, V _{GS} =0V	-	0.8	1.1	V
t _{rr}	Reverse Recovery Time	I _{DS} =20A, di _{SD} /dt=100A/μs	-	35.6	-	ns
t _a	Charge Time		-	19.3	-	
t _b	Discharge Time		-	16.3	-	
Q _{rr}	Reverse Recovery Charge		-	26	-	
Dynamic Characteristics^e						
R _G	Gate Resistance	V _{GS} =0V, V _{DS} =0V, F=1MHz	-	1	2	Ω
C _{iss}	Input Capacitance	V _{GS} =0V, V _{DS} =15V, Frequency=1.0MHz	-	2485	2971	pF
C _{oss}	Output Capacitance		-	850	-	
C _{rss}	Reverse Transfer Capacitance		-	85	-	
t _{d(ON)}	Turn-on Delay Time	V _{DD} =15V, R _L =15Ω, I _{DS} =1A, V _{GEN} =10V, R _G =6Ω	-	12.4	23	ns
t _r	Turn-on Rise Time		-	9.5	18	
t _{d(OFF)}	Turn-off Delay Time		-	27.2	49	
t _f	Turn-off Fall Time		-	35.2	64	
Gate Charge Characteristics^e						
Q _g	Total Gate Charge	V _{DS} =15V, V _{GS} =10V, I _{DS} =20A	-	20.6	28.8	nC
Q _g	Total Gate Charge	V _{DS} =15V, V _{GS} =4.5V, I _{DS} =20A	-	9.8	-	
Q _{gth}	Threshold Gate Charge		-	1.8	-	
Q _{gs}	Gate-Source Charge		-	3.8	-	
Q _{gd}	Gate-Drain Charge		-	3.7	-	

Note d : Pulse test ; pulse width≤300μs, duty cycle≤2%.

Note e : Guaranteed by design, not subject to production testing.



CST120N03 Typical Operating Characteristics

Power Dissipation

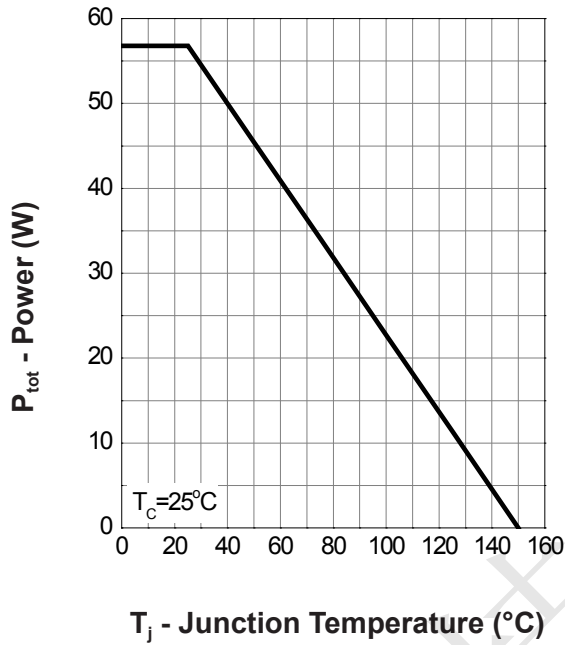

Drain Current

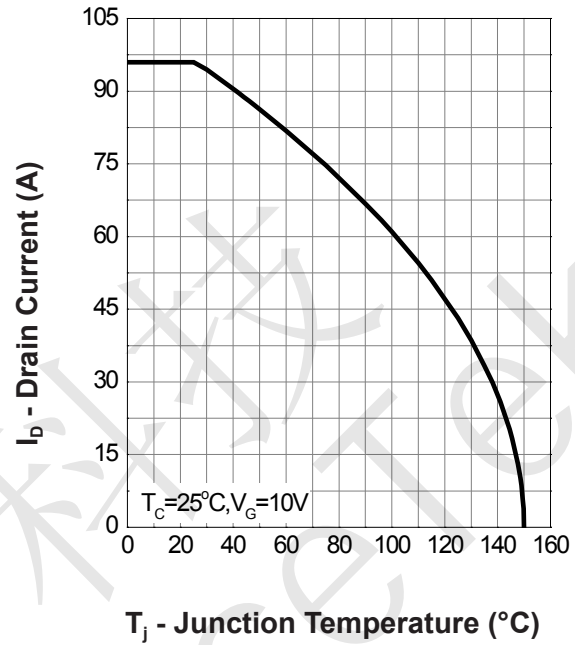

Safe Operation Area

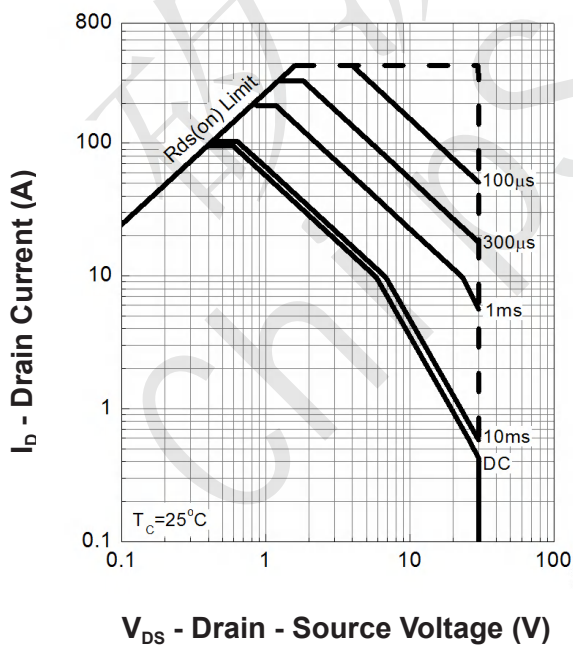

Thermal Transient Impedance

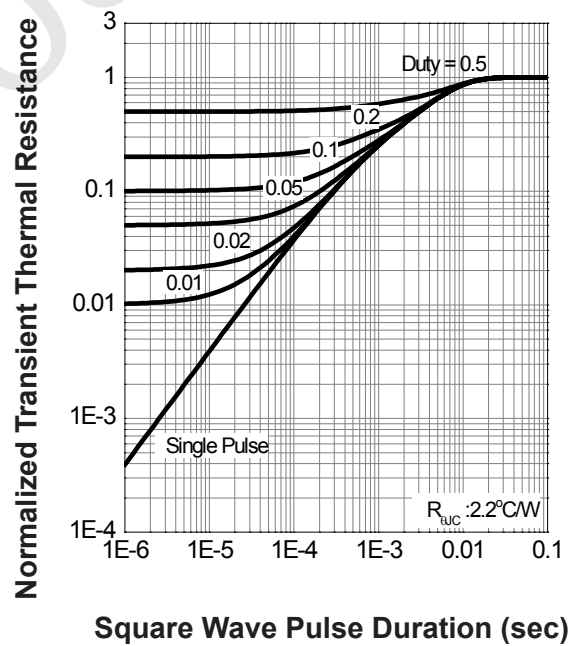



CST120N03 Typical Operating Characteristics(Cont.)

Safe Operation Area

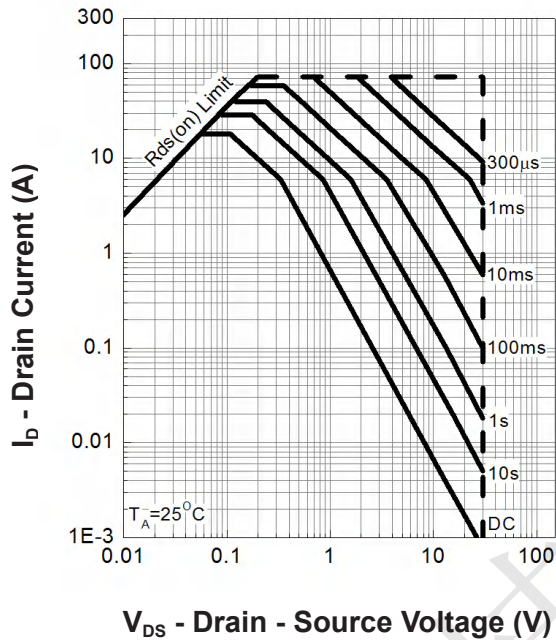

Thermal Transient Impedance

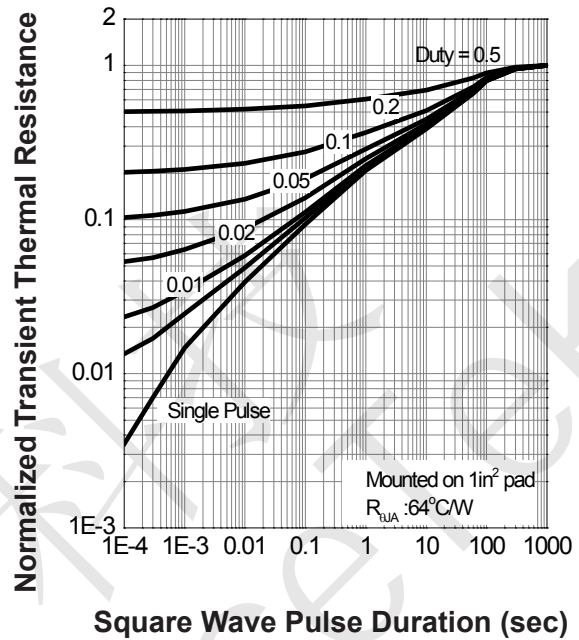

Output Characteristics

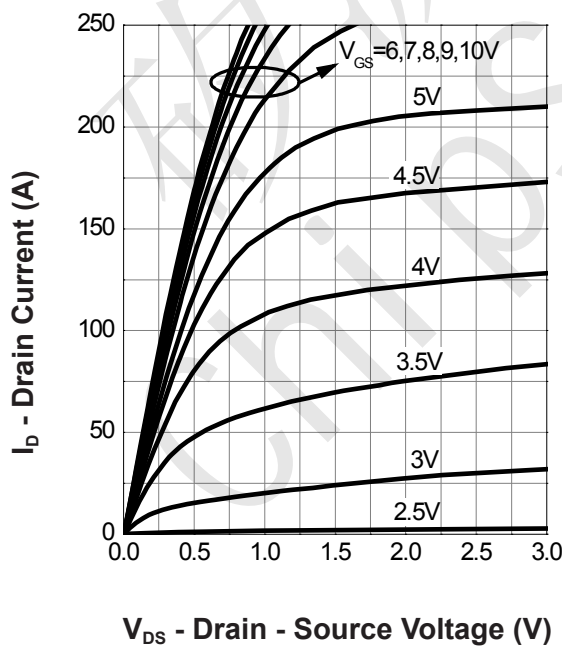

Drain-Source On Resistance

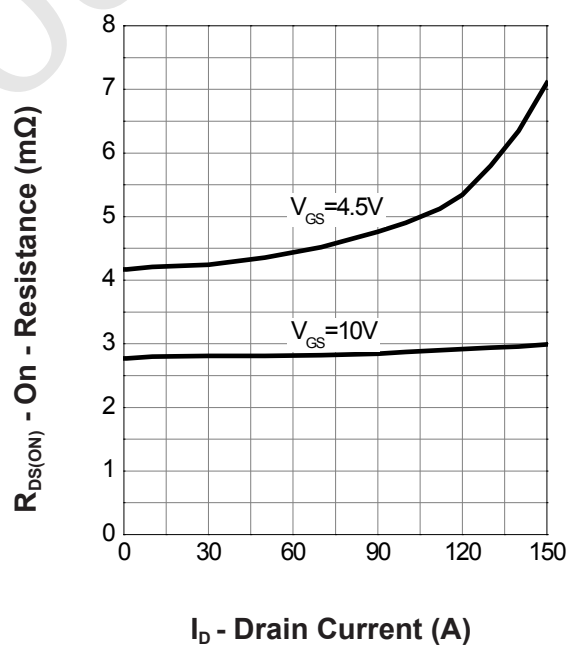



CST120N03 Typical Operating Characteristics(Cont.)

Gate-Source On Resistance

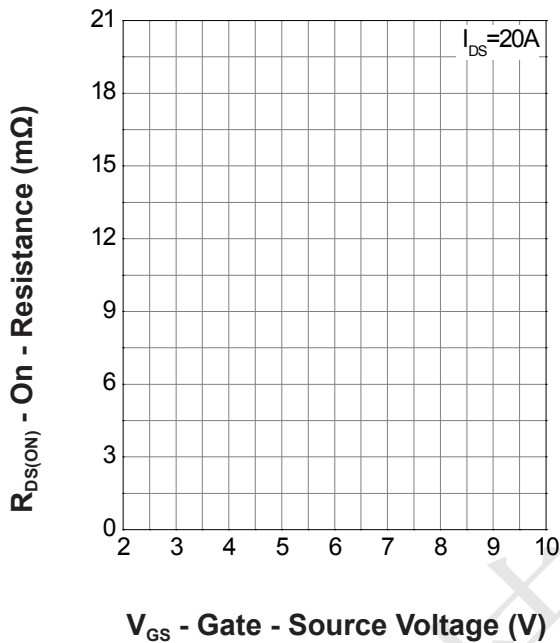

Gate Threshold Voltage

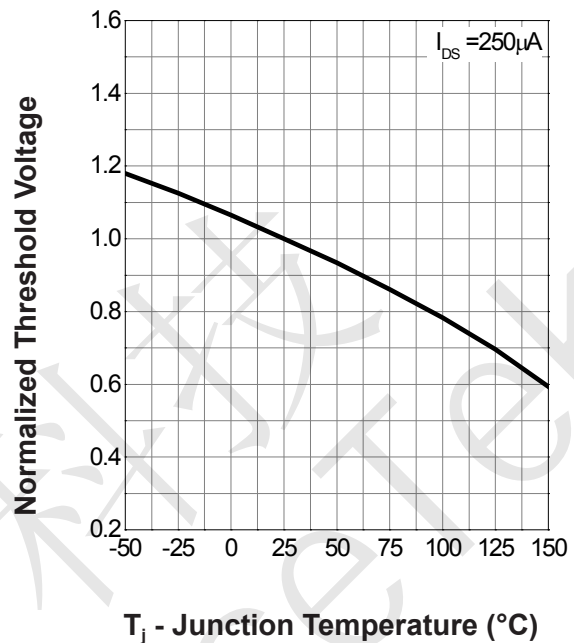

Drain-Source On Resistance

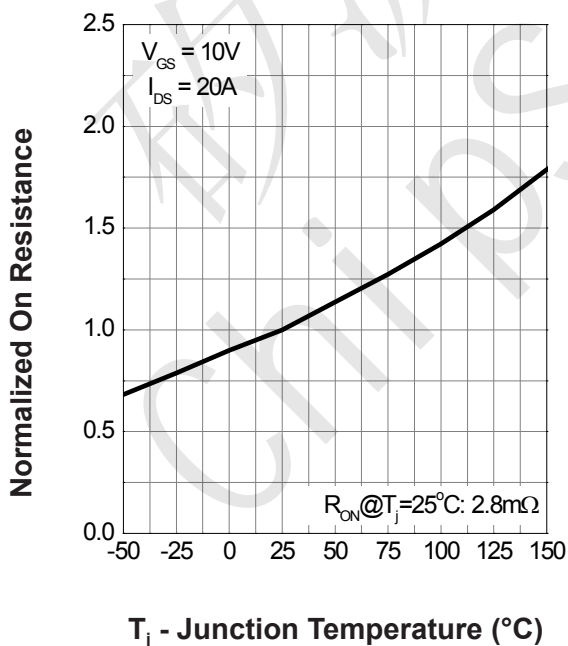

Source-Drain Diode Forward

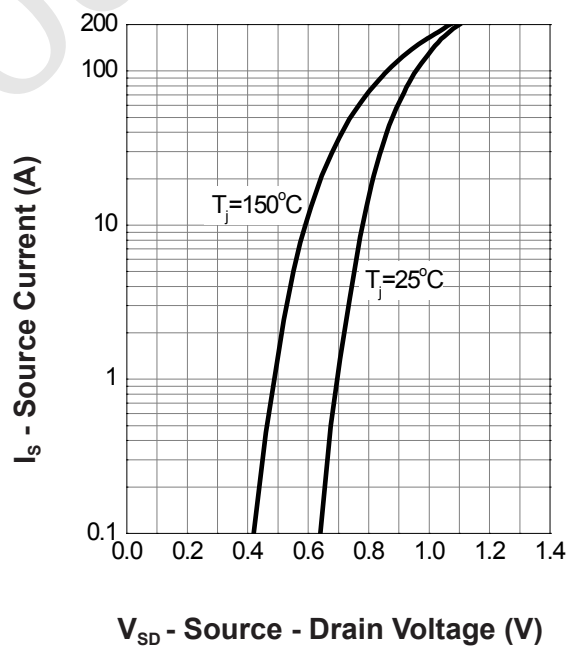



CST120N03 Typical Operating Characteristics(Cont.)

Capacitance

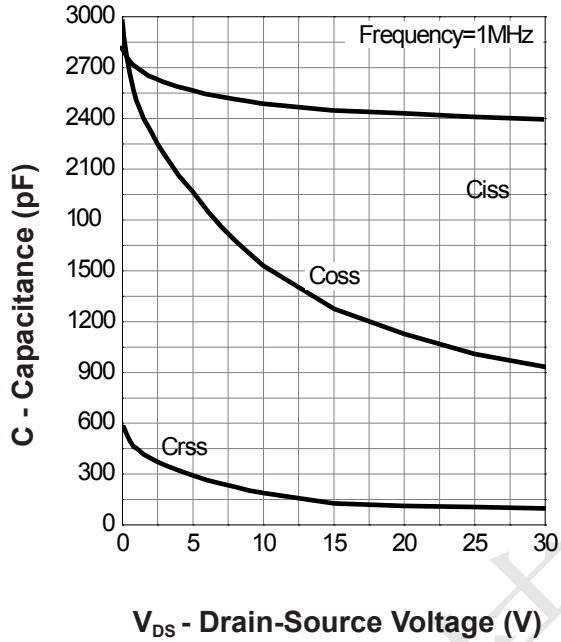

Gate Charge

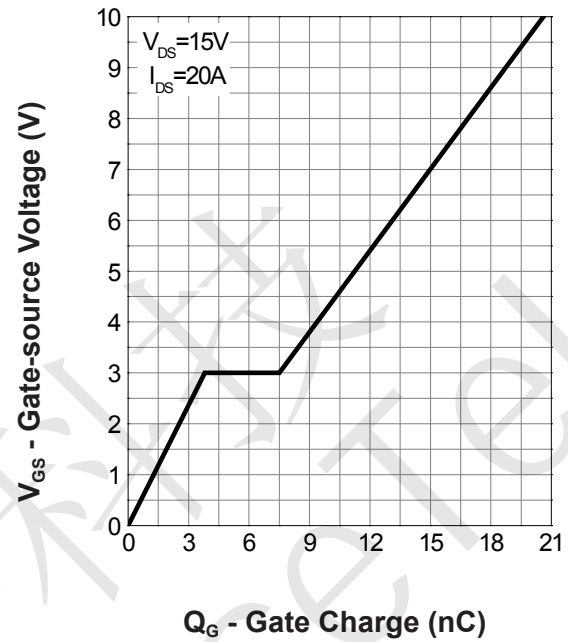



CST120N03 Package Mechanical Data TO 252

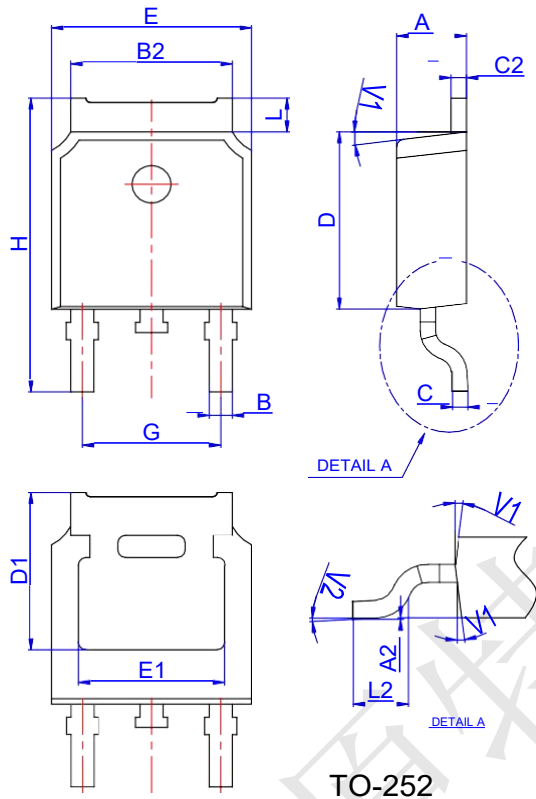

Ref.	Dimensions					
	Millimeters			Inches		
	Min.	Typ.	Max.	Min.	Typ.	Max.
A	2.10		2.50	0.083		0.098
A2	0		0.10	0		0.004
B	0.66		0.86	0.026		0.034
B2	5.18		5.48	0.202		0.216
C	0.40		0.60	0.016		0.024
C2	0.44		0.58	0.017		0.023
D	5.90		6.30	0.232		0.248
D1	5.30REF			0.209REF		
E	6.40		6.80	0.252		0.268
E1	4.63			0.182		
G	4.47		4.67	0.176		0.184
H	9.50		10.70	0.374		0.421
L	1.09		1.21	0.043		0.048
L2	1.35		1.65	0.053		0.065
V1		7°			7°	
V2	0°		6°	0°		6°

CST120N03 Reel Specification-TO-252-4R

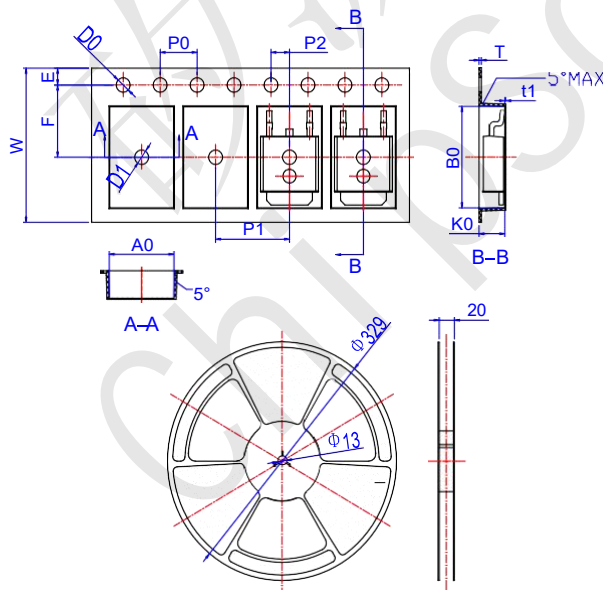

Ref.	Dimensions					
	Millimeters			Inches		
	Min.	Typ.	Max.	Min.	Typ.	Max.
W	15.90	16.00	16.10	0.626	0.630	0.634
E	1.65	1.75	1.85	0.065	0.069	0.073
F	7.40	7.50	7.60	0.291	0.295	0.299
D0	1.40	1.50	1.60	0.055	0.059	0.063
D1	1.40	1.50	1.60	0.055	0.059	0.063
P0	3.90	4.00	4.10	0.154	0.157	0.161
P1	7.90	8.00	8.10	0.311	0.315	0.319
P2	1.90	2.00	2.10	0.075	0.079	0.083
A0	6.85	6.90	7.00	0.270	0.271	0.276
B0	10.45	10.50	10.60	0.411	0.413	0.417
K0	2.68	2.78	2.88	0.105	0.109	0.113
T	0.24		0.27	0.009		0.011
t1	0.10			0.004		
10P0	39.80	40.00	40.20	1.567	1.575	1.583