



### CST2302V N-Ch 20V Fast Switching MOSFETs

- ★ Green Device Available
- ★ Super Low Gate Charge
- ★ Excellent Cdv/dt effect decline
- ★ Advanced high cell density Trench technology

#### CST2302V Product Summary



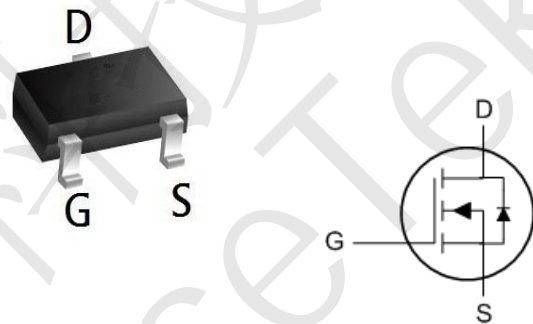
BVDSS	RDSON	ID
20V	45 mΩ	3.0 A

#### CST2302V Description

The CST2302V is the high cell density trenched N-ch MOSFETs, which provides excellent RDSON and efficiency for most of the small power switching and load switch applications.

The CST2302V meet the RoHS and Green Product requirement with full function reliability approved.

#### CST2302V SOT23 Pin Configuration



#### CST2302V Absolute Maximum Ratings

Symbol	Parameter	Rating	Units
$V_{DS}$	Drain-Source Voltage	20	V
$V_{GS}$	Gate-Source Voltage	$\pm 12$	V
$I_D@T_A=25^\circ C$	Continuous Drain Current, $V_{GS} @ 10V^1$	3.0	A
$I_D@T_A=70^\circ C$	Continuous Drain Current, $V_{GS} @ 10V^1$	1.2	A
$I_{DM}$	Pulsed Drain Current <sup>2</sup>	12	A
$P_D@T_A=25^\circ C$	Total Power Dissipation <sup>3</sup>	0.85	W
$T_{STG}$	Storage Temperature Range	-55 to 150	$^\circ C$
$T_J$	Operating Junction Temperature Range	-55 to 150	$^\circ C$

#### CST2302V Thermal Data

Symbol	Parameter	Typ.	Max.	Unit
$R_{\theta JA}$	Thermal Resistance Junction-ambient <sup>1</sup>	---	162	$^\circ C/W$
$R_{\theta JC}$	Thermal Resistance Junction-Case <sup>1</sup>	---	---	$^\circ C/W$



### CST2302V N-Ch 20V Fast Switching MOSFETs

#### CST2302V Electrical Characteristics (T<sub>J</sub>=25°C unless otherwise specified)

Symbol	Parameter	Test Condition	Min.	Typ.	Max.	Units
<b>Off Characteristic</b>						
V <sub>(BR)DSS</sub>	Drain-Source Breakdown Voltage	V <sub>GS</sub> =0V, I <sub>D</sub> =250μA	20	-	-	V
I <sub>DSS</sub>	Zero Gate Voltage Drain Current	V <sub>DS</sub> =20V, V <sub>GS</sub> =0V,	-	-	1.0	μA
I <sub>GSS</sub>	Gate to Body Leakage Current	V <sub>DS</sub> =0V, V <sub>GS</sub> =±12V	-	-	±100	nA
<b>On Characteristics</b>						
V <sub>GS(th)</sub>	Gate Threshold Voltage	V <sub>DS</sub> =V <sub>GS</sub> , I <sub>D</sub> =250μA	0.4	0.7	1.0	V
R <sub>DS(on)</sub>	Static Drain-Source on-Resistance note2	V <sub>GS</sub> =4.5V, I <sub>D</sub> =3A	-	45	55	mΩ
		V <sub>GS</sub> =2.5V, I <sub>D</sub> =2A	-	62	85	
<b>Dynamic Characteristics</b>						
C <sub>iss</sub>	Input Capacitance	V <sub>DS</sub> =10V, V <sub>GS</sub> =0V, f=1.0MHz	-	184	-	pF
C <sub>oss</sub>	Output Capacitance		-	38	-	pF
C <sub>rss</sub>	Reverse Transfer Capacitance		-	28	-	pF
Q <sub>g</sub>	Total Gate Charge	V <sub>DS</sub> =10V, I <sub>D</sub> =3A, V <sub>GS</sub> =4.5V	-	2.7	-	nC
Q <sub>gs</sub>	Gate-Source Charge		-	0.4	-	nC
Q <sub>gd</sub>	Gate-Drain("Miller") Charge		-	0.5	-	nC
<b>Switching Characteristics</b>						
t <sub>d(on)</sub>	Turn-on Delay Time	V <sub>DS</sub> =10V, I <sub>D</sub> =3A, R <sub>GEN</sub> =3Ω, V <sub>GS</sub> =4.5V	-	8	-	ns
t <sub>r</sub>	Turn-on Rise Time		-	27	-	ns
t <sub>d(off)</sub>	Turn-off Delay Time		-	26	-	ns
t <sub>f</sub>	Turn-off Fall Time		-	33	-	ns
<b>Drain-Source Diode Characteristics and Maximum Ratings</b>						
I <sub>S</sub>	Maximum Continuous Drain to Source Diode Forward Current		-	-	3	A
I <sub>SM</sub>	Maximum Pulsed Drain to Source Diode Forward Current		-	-	12	A
V <sub>SD</sub>	Drain to Source Diode Forward Voltage	V <sub>GS</sub> =0V, I <sub>S</sub> =3A	-	-	1.2	V

Notes: 1. Repetitive Rating: Pulse Width Limited by Maximum Junction Temperature

2. Pulse Test: Pulse Width≤300μs, Duty Cycle≤0.5%



### CST2302V Typical Performance Characteristics

Figure 1: Output Characteristics

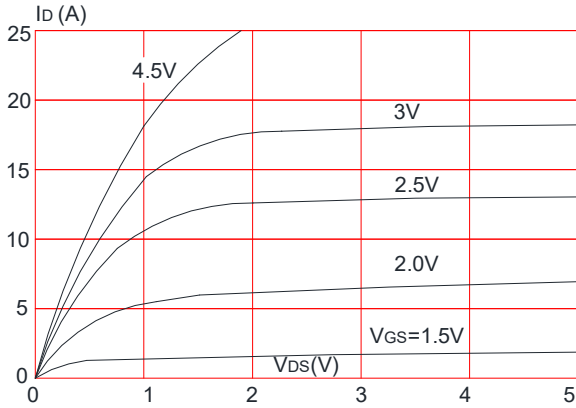


Figure 2: Typical Transfer Characteristics

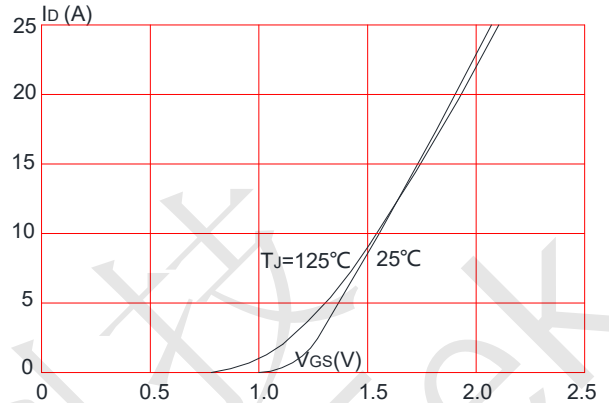


Figure 3: On-resistance vs. Drain Current

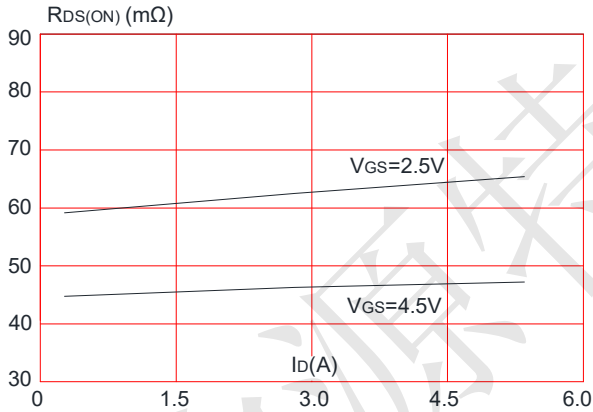


Figure 4: Body Diode Characteristics

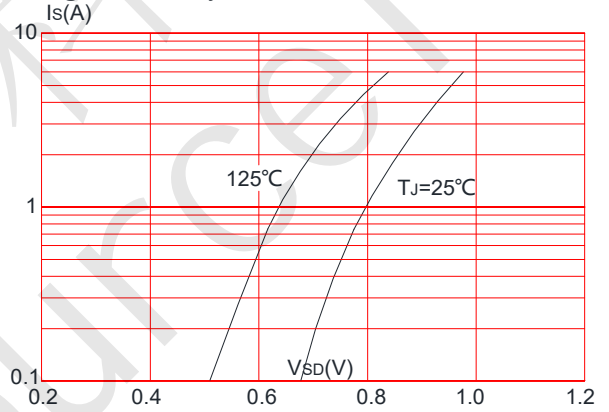


Figure 5: Gate Charge Characteristics

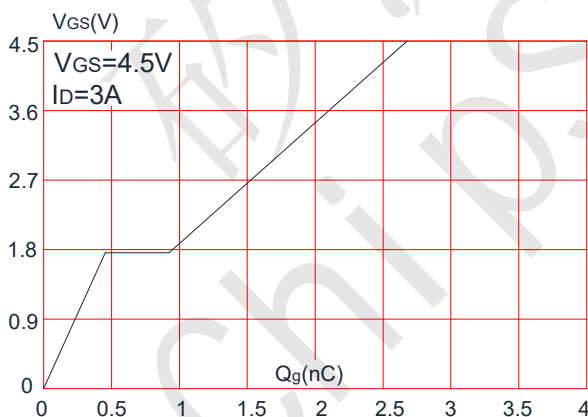
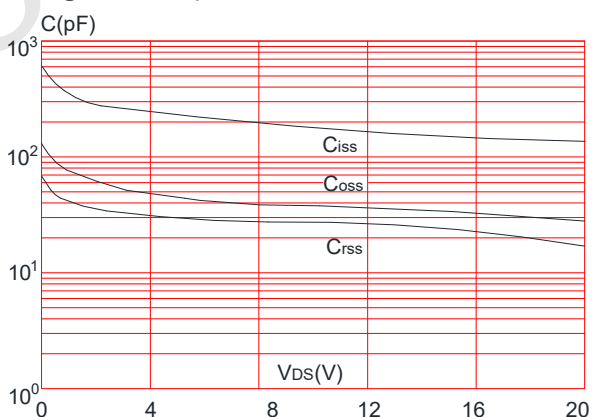


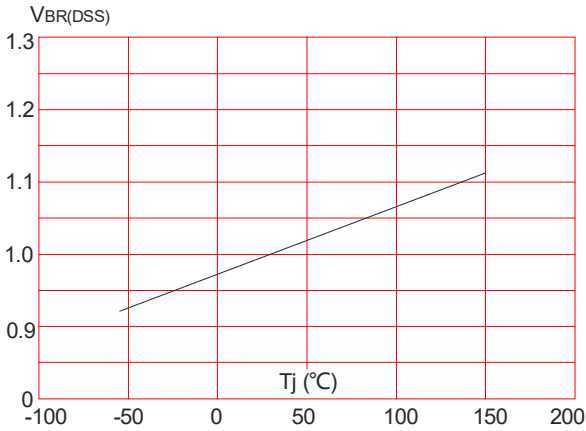
Figure 6: Capacitance Characteristics



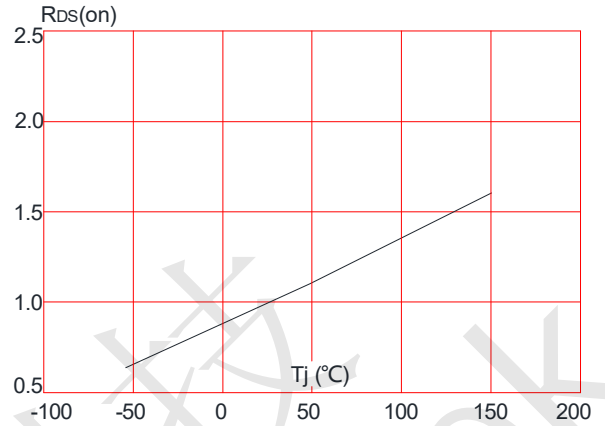


### CST2302V N-Ch 20V Fast Switching MOSFETs

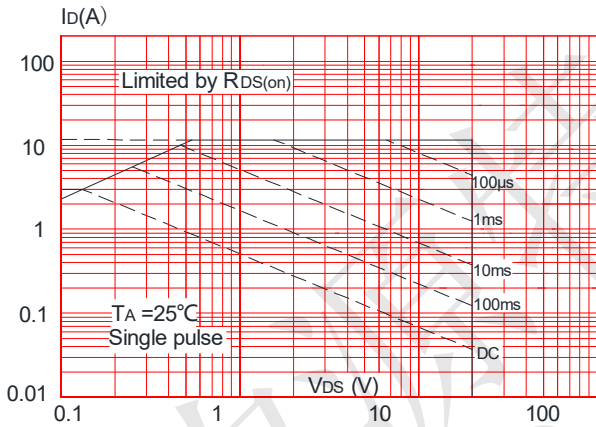
**Figure 7:** Normalized Breakdown Voltage vs. Junction Temperature



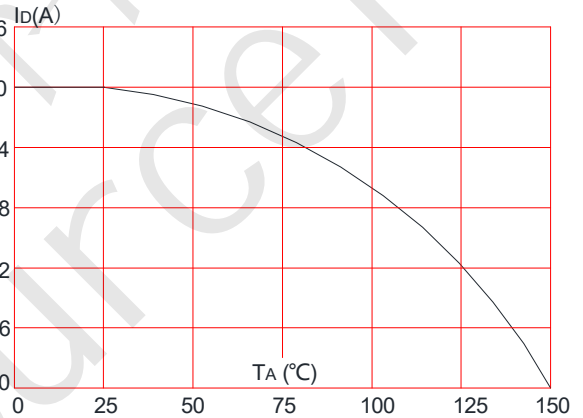
**Figure 8:** Normalized on Resistance vs. Junction Temperature



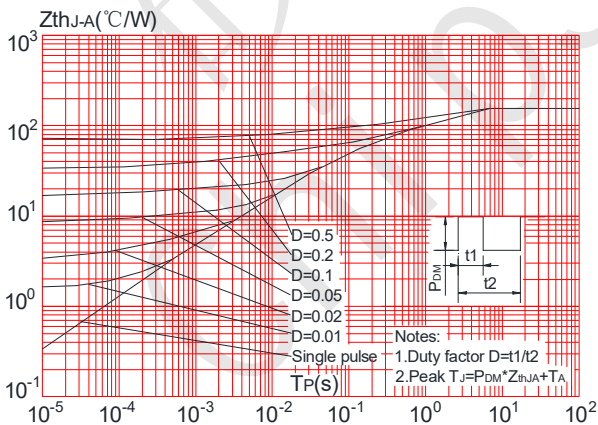
**Figure 9:** Maximum Safe Operating Area



**Figure 10:** Maximum Continuous Drain Current vs. Ambient Temperature

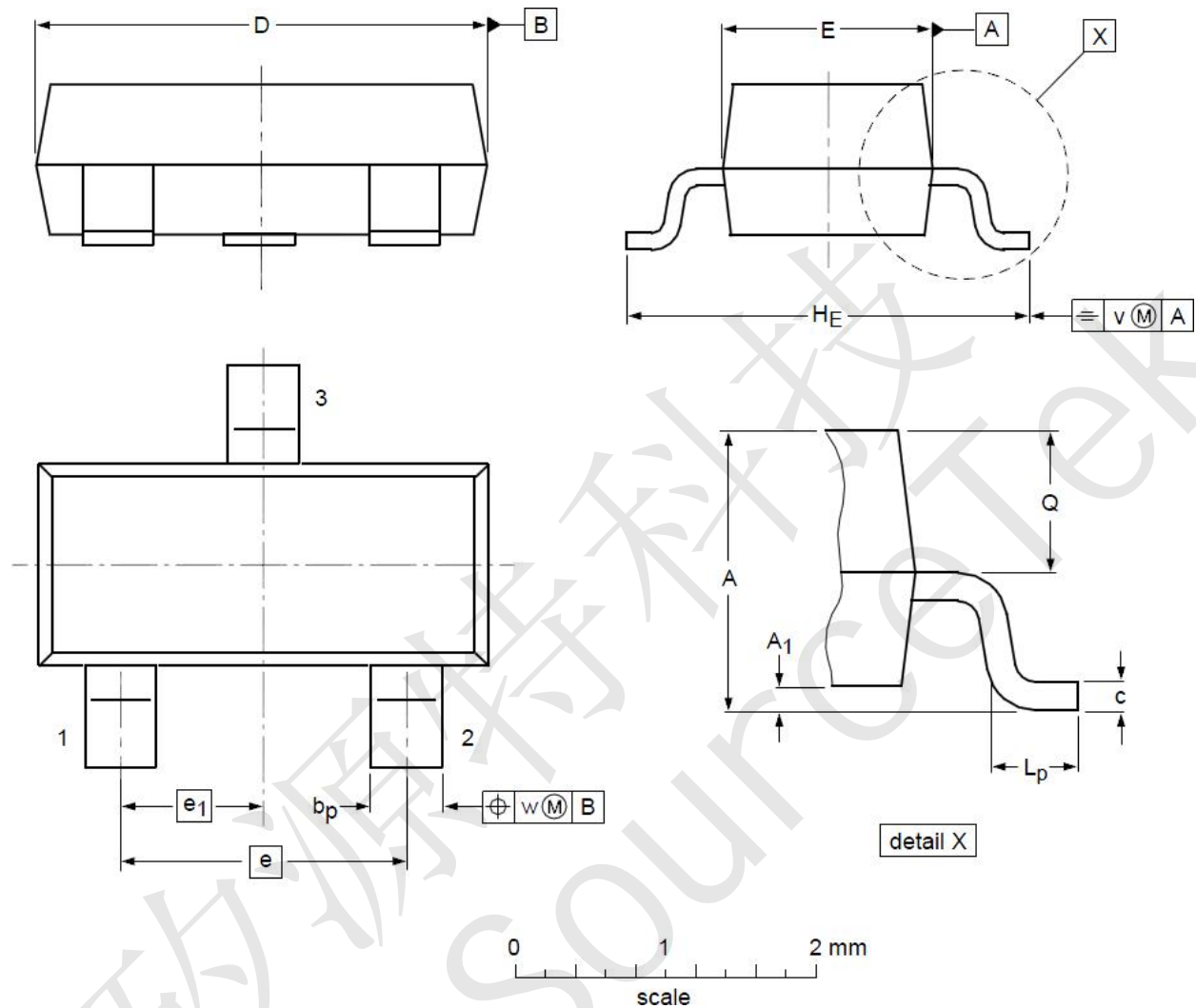


**Figure 11:** Maximum Effective Transient Thermal Impedance, Junction-to-Ambient





CST2302V SOT23 Mechanical Data



DIMENSIONS ( unit : mm )

Symbol	Min	Typ	Max	Symbol	Min	Typ	Max
A	0.90	1.01	1.15	A <sub>1</sub>	0.01	0.05	0.10
b <sub>p</sub>	0.30	0.42	0.50	c	0.08	0.13	0.15
D	2.80	2.92	3.00	E	1.20	1.33	1.40
e	--	1.90	--	e <sub>1</sub>	--	0.95	--
H <sub>E</sub>	2.25	2.40	2.55	L <sub>p</sub>	0.30	0.42	0.50
Q	0.45	0.49	0.55	v	--	0.20	--
w	--	0.10	--				