



CST3019A P-Ch 30V Fast Switching MOSFETs

- ★ 100% EAS Guaranteed
- ★ Green Device Available
- ★ Super Low Gate Charge
- ★ Excellent CdV/dt effect decline
- ★ Advanced high cell density Trench technology

CST3019A Product Summary



BVDSS	RDSON	ID
-30V	8.3 mΩ	-55A

CST3019A PDFN5060-8L Pin Configuration

CST3019A Description

The CST3019A is the high cell density trenched P-ch MOSFETs, which provide excellent RDSON and gate charge for most of the synchronous buck converter applications.

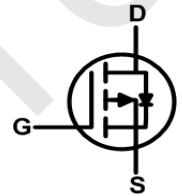
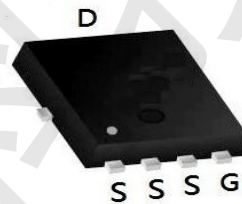

CST3019A Absolute Maximum Ratings (T_C=25°C unless otherwise specified)

Symbol	Parameter	Max.	Units	
V _{DSS}	Drain-Source Voltage	-30	V	
V _{GSS}	Gate-Source Voltage	±20	V	
I _D	Continuous Drain Current	T _C = 25°C	-55	A
		T _C = 100°C	-23	A
I _{DM}	Pulsed Drain Current ^{note1}	-140	A	
E _{AS}	Single Pulsed Avalanche Energy ^{note2}	78.8	mJ	
P _D	Power Dissipation	T _C = 25°C	21.5	W
R _{θJC}	Thermal Resistance, Junction to Case	5.8	°C/W	
T _J , T _{STG}	Operating and Storage Temperature Range	-55 to +150	°C	



CST3019A P-Ch 30V Fast Switching MOSFETs

CST3019A Electrical Characteristics (T_J=25°C unless otherwise specified)

Symbol	Parameter	Test Condition	Min.	Typ.	Max.	Units
Off Characteristic						
V _{(BR)DSS}	Drain-Source Breakdown Voltage	V _{GS} =0V, I _D = -250μA	-30	-	-	V
I _{DSS}	Zero Gate Voltage Drain Current	V _{DS} = -30V, V _{GS} = 0V,	-	-	-1	μA
I _{GSS}	Gate to Body Leakage Current	V _{DS} =0V, V _{GS} = ±20V	-	-	±100	nA
On Characteristics						
V _{GS(th)}	Gate Threshold Voltage	V _{DS} = V _{GS} , I _D = -250μA	-1.0	-1.5	-2.5	V
R _{DS(on)}	Static Drain-Source on-Resistance note3	V _{GS} = -10V, I _D = -12A	-	8.3	11	mΩ
		V _{GS} = -4.5V, I _D = -8A	-	13	18	
Dynamic Characteristics						
C _{iss}	Input Capacitance	V _{DS} = -15V, V _{GS} = 0V, f = 1.0MHz	-	2800	-	pF
C _{oss}	Output Capacitance		-	346	-	pF
C _{rss}	Reverse Transfer Capacitance		-	319	-	pF
Q _g	Total Gate Charge	V _{DS} = -15V, I _D = -20A, V _{GS} = -10V	-	30	-	nC
Q _{gs}	Gate-Source Charge		-	5.3	-	nC
Q _{gd}	Gate-Drain("Miller") Charge		-	7.6	-	nC
Switching Characteristics						
t _{d(on)}	Turn-on Delay Time	V _{DD} = -15V, I _D = -20A, V _{GS} =-10V, R _{GEN} =2.5Ω	-	14	-	ns
t _r	Turn-on Rise Time		-	20	-	ns
t _{d(off)}	Turn-off Delay Time		-	95	-	ns
t _f	Turn-off Fall Time		-	65	-	ns
Drain-Source Diode Characteristics and Maximum Ratings						
I _S	Maximum Continuous Drain to Source Diode Forward Current		-	-	-55	A
I _{SM}	Maximum Pulsed Drain to Source Diode Forward Current		-	-	-140	A
V _{SD}	Drain to Source Diode Forward Voltage	V _{GS} = 0V, I _S = -35A	-	-0.8	-1.2	V

Notes:1. Repetitive Rating: Pulse Width Limited by Maximum Junction Temperature

2. EAS condition: T_J= 25°C, V_{DD}= -20V, V_G= -10V, L= 0.5mH, R_G= 25 Ω, I_{AS}= -17A

3. Pulse Test: Pulse Width≤300μs, Duty Cycle≤2%



CST3019A Typical Performance Characteristics

Figure 1: Output Characteristics

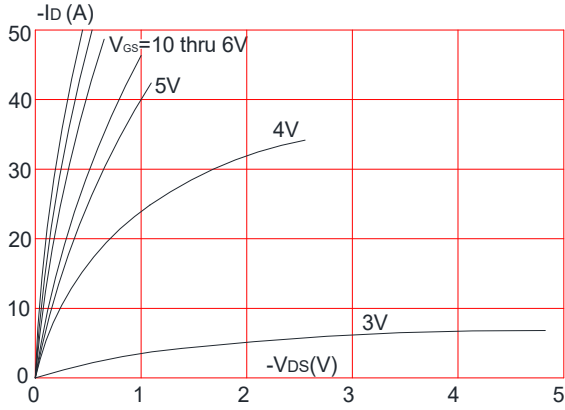

Figure 2: Typical Transfer Characteristics

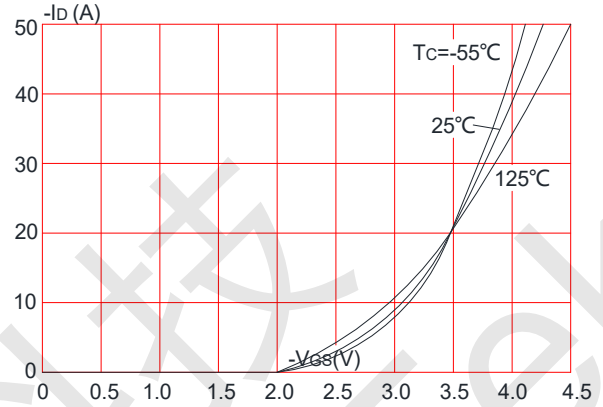

Figure 3: On-resistance vs. Drain Current

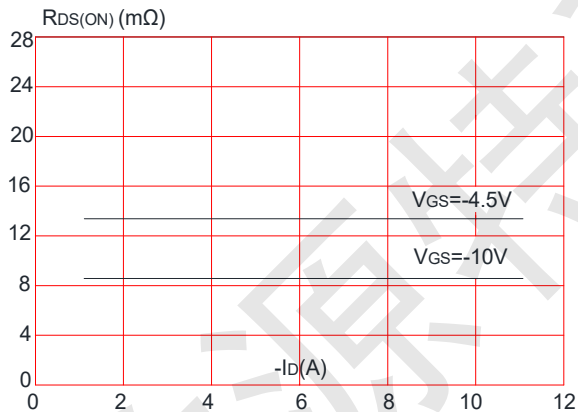

Figure 4: Body Diode Characteristics

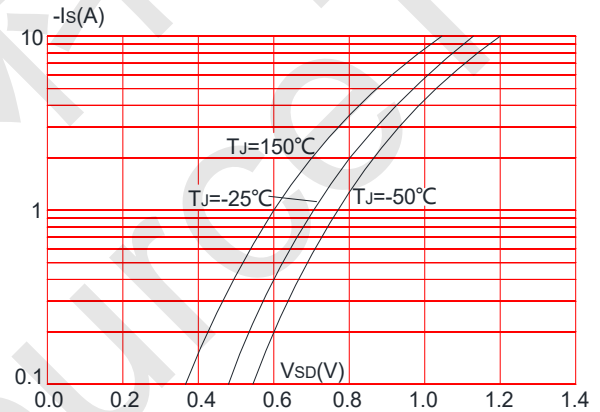

Figure 5: Gate Charge Characteristics

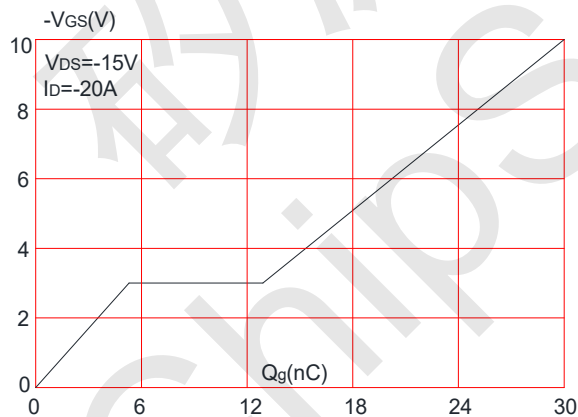
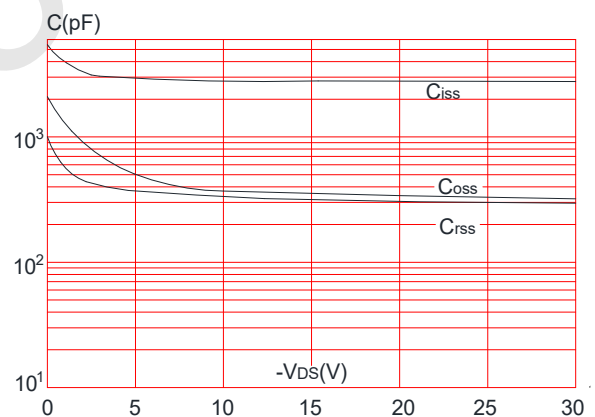

Figure 6: Capacitance Characteristics





CST3019A P-Ch 30V Fast Switching MOSFETs

Figure 7: Normalized Breakdown Voltage vs. Junction Temperature

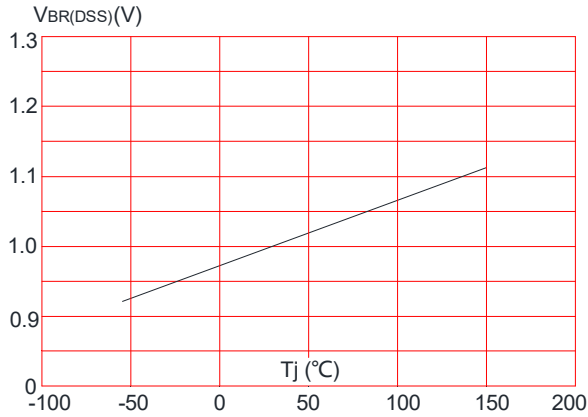

Figure 8: Normalized on Resistance vs. Junction Temperature

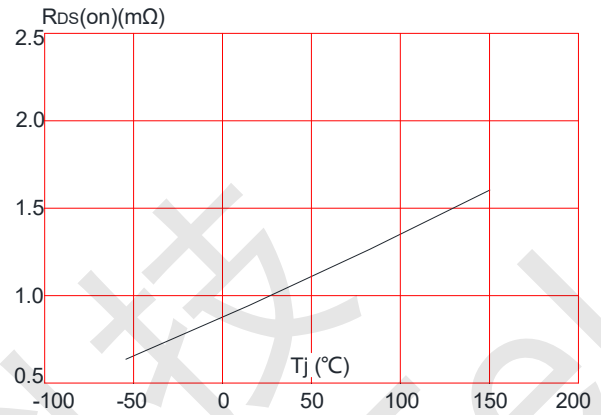

Figure 9: Maximum Safe Operating Area

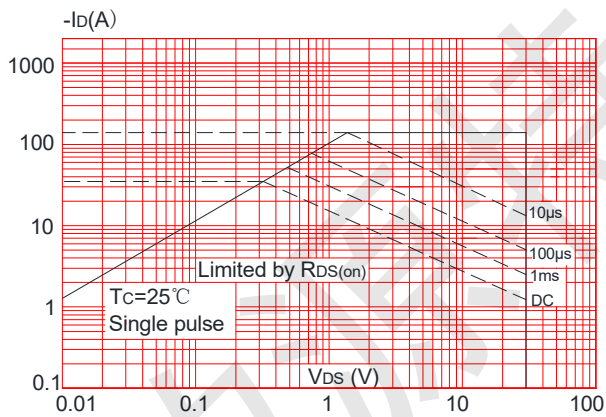

Figure 10: Maximum Continuous Drain Current vs. Case Temperature

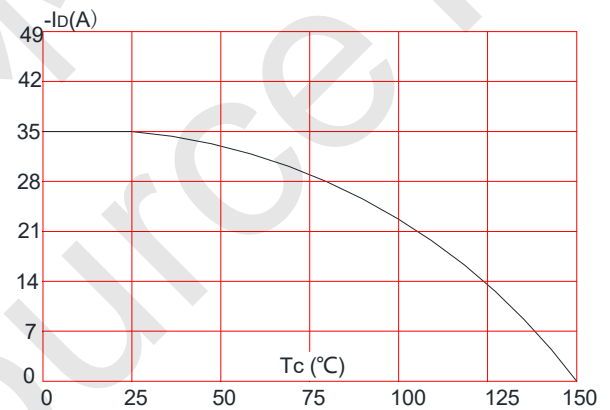
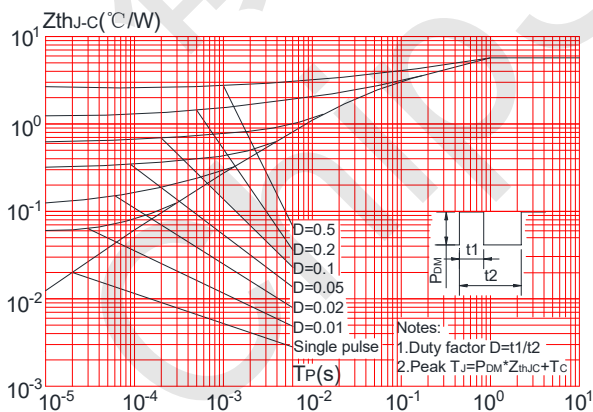
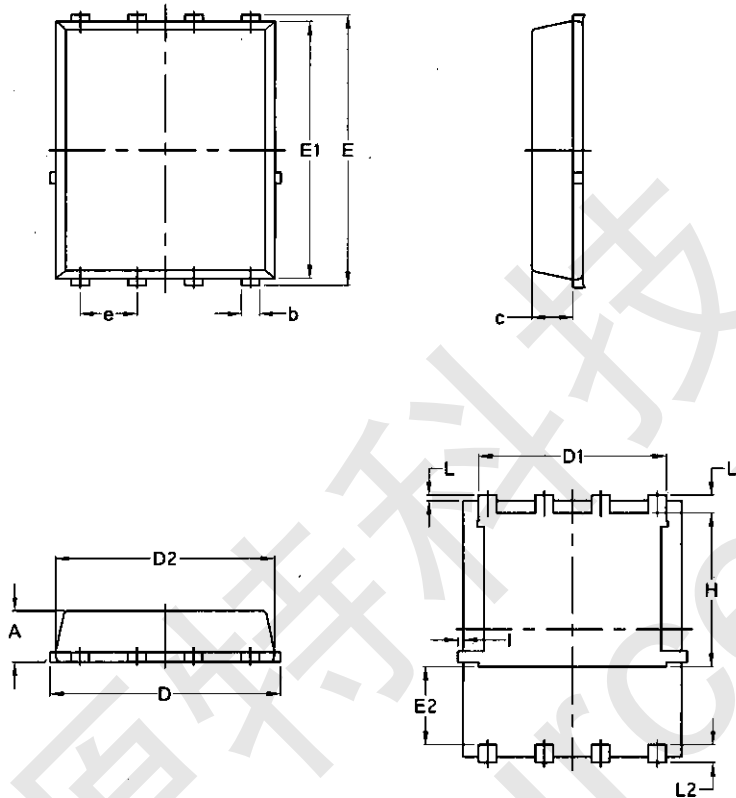

Figure.11: Maximum Effective Transient Thermal Impedance, Junction-to-Case





CST3019A Package Mechanical Data-PDFN5060-8L-JQ Single



Symbol	Common			
	mm		Inch	
	Min	Max	Min	Max
A	1.03	1.17	0.0406	0.0461
b	0.34	0.48	0.0134	0.0189
c	0.824	0.0970	0.0324	0.082
D	4.80	5.40	0.1890	0.2126
D1	4.11	4.31	0.1618	0.1697
D2	4.80	5.00	0.1890	0.1969
E	5.95	6.15	0.2343	0.2421
E1	5.65	5.85	0.2224	0.2303
E2	1.60	/	0.0630	/
e	1.27 BSC		0.05 BSC	
L	0.05	0.25	0.0020	0.0098
L1	0.38	0.50	0.0150	0.0197
L2	0.38	0.50	0.0150	0.0197
H	3.30	3.50	0.1299	0.1378
I	/	0.18	/	0.0070