



CST302 Dual N-Ch 30V Fast Switching MOSFETs

- ★ 100% EAS Guaranteed
- ★ Green Device Available
- ★ Super Low Gate Charge
- ★ Excellent CdV/dt effect decline
- ★ Advanced high cell density Trench technology

CST302 Product Summary



BVDSS	RDSON	ID
30V	10mΩ	30A

CST302 Description

The CST302 is the high cell density trenched N-ch MOSFETs, which provide excellent RDSON and gate charge for most of the synchronous buck converter applications.

The CST302 meet the RoHS and Green Product requirement 100% EAS guaranteed with full function reliability approved.

CST302 PDFN3333-8L Pin Configuration

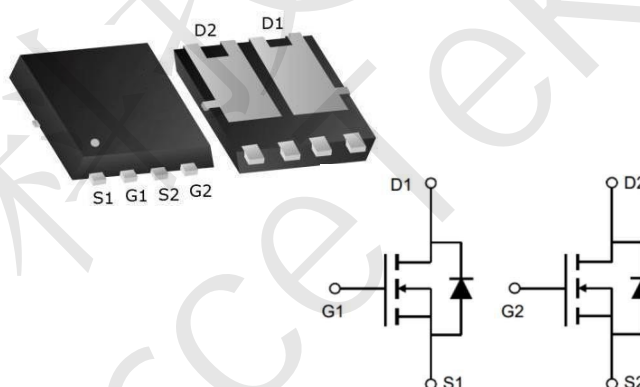

CST302 Absolute Maximum Ratings

Symbol	Parameter	Rating	Units
V_{DS}	Drain-Source Voltage	30	V
V_{GS}	Gate-Source Voltage	± 20	V
$I_D@T_A=25^\circ C$	Continuous Drain Current, $V_{GS} @ 10V^1$	30	A
$I_D@T_A=70^\circ C$	Continuous Drain Current, $V_{GS} @ 10V^1$	18	A
I_{DM}	Pulsed Drain Current ²	50	A
EAS	Single Pulse Avalanche Energy ³	24.2	mJ
I_{AS}	Avalanche Current	22	A
$P_D@T_A=25^\circ C$	Total Power Dissipation ⁴	1.5	W
T_{STG}	Storage Temperature Range	-55 to 150	$^\circ C$
T_J	Operating Junction Temperature Range	-55 to 150	$^\circ C$

CST302 Thermal Data

Symbol	Parameter	Typ.	Max.	Unit
$R_{\theta JA}$	Thermal Resistance Junction-Ambient ¹	---	85	$^\circ C/W$



CST302 Dual N-Ch 30V Fast Switching MOSFETs

CST302 Electrical Characteristics (T_J=25 °C, unless otherwise noted)

Symbol	Parameter	Test Condition	Min.	Typ.	Max.	Units
V _{(BR)DSS}	Drain-Source Breakdown Voltage	V _{GS} =0V, I _D =250μA	30	-	-	V
I _{DSS}	Zero Gate Voltage Drain Current	V _{DS} =30V, V _{GS} =0V,	-	-	1.0	μA
I _{GSS}	Gate to Body Leakage Current	V _{DS} =0V, V _{GS} =±20V	-	-	±100	nA
V _{GS(th)}	Gate Threshold Voltage	V _{DS} =V _{GS} , I _D =250μA	1.0	1.5	2.5	V
R _{DS(on)}	Static Drain-Source on-Resistance <small>note3</small>	V _{GS} =10V, I _D =10A	-	10	14	mΩ
		V _{GS} =4.5V, I _D =5A	-	18	25	
C _{iss}	Input Capacitance	V _{DS} =15V, V _{GS} =0V, f=1.0MHz	-	614	-	pF
C _{oss}	Output Capacitance		-	118	-	pF
C _{rss}	Reverse Transfer Capacitance		-	98	-	pF
Q _g	Total Gate Charge	V _{DS} =15V, I _D =11A, V _{GS} =10V	-	16	-	nC
Q _{gs}	Gate-Source Charge		-	2.7	-	nC
Q _{gd}	Gate-Drain("Miller") Charge		-	4.5	-	nC
t _{d(on)}	Turn-on Delay Time	V _{DS} =15V, R _L =1.35Ω, R _{GEN} =3Ω, V _{GS} =10V	-	6	-	ns
t _r	Turn-on Rise Time		-	10	-	ns
t _{d(off)}	Turn-off Delay Time		-	30	-	ns
t _f	Turn-off Fall Time		-	6.5	-	ns
I _S	Maximum Continuous Drain to Source Diode Forward Current		-	-	30	A
I _{SM}	Maximum Pulsed Drain to Source Diode Forward Current		-	-	60	A
V _{SD}	Drain to Source Diode Forward Voltage	V _{GS} =0V, I _S =15A	-	-	1.2	V
t _{rr}	Body Diode Reverse Recovery Time	I _F =11A, di/dt=500A/μs	-	7	-	ns
Q _{rr}	Body Diode Reverse Recovery Charge		-	10	-	nC

CST302 Diode Characteristics

Symbol	Parameter	Conditions	Min.	Typ.	Max.	Unit
I _S	Continuous Source Current ^{1,5}	V _G =V _D =0V, Force Current	---	---	30	A
V _{SD}	Diode Forward Voltage ²	V _{GS} =0V, I _S =1A, T _J =25°C	---	---	1	V
t _{rr}	Reverse Recovery Time	I _F =8A, di/dt=100A/μs,	---	8	---	nS
Q _{rr}	Reverse Recovery Charge	T _J =25°C	---	2.9	---	nC

Note :



CST302 Typical Performance Characteristics

Figure 1: Output Characteristics

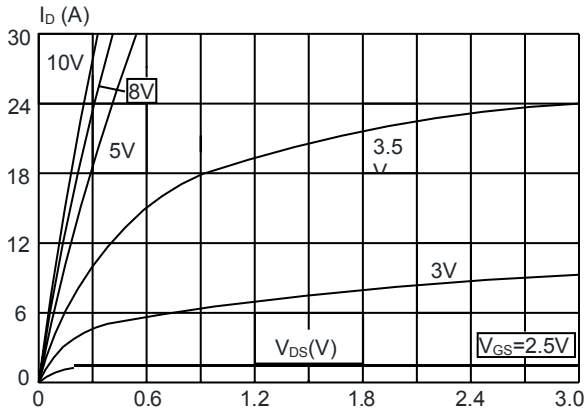

Figure 2: Typical Transfer Characteristics

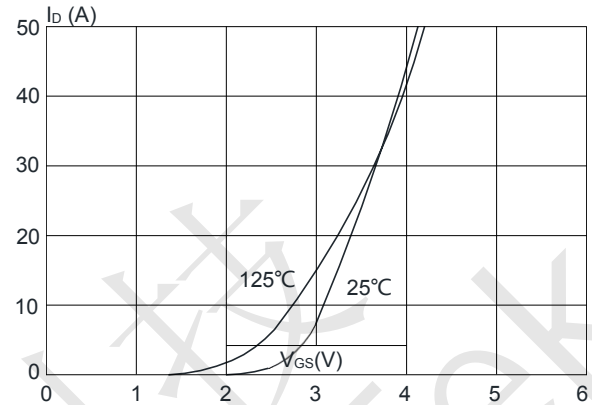

Figure 3: On-resistance vs. Drain Current

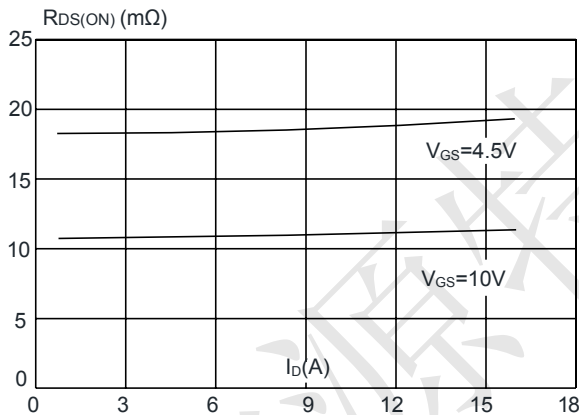

Figure 4: Body Diode Characteristics

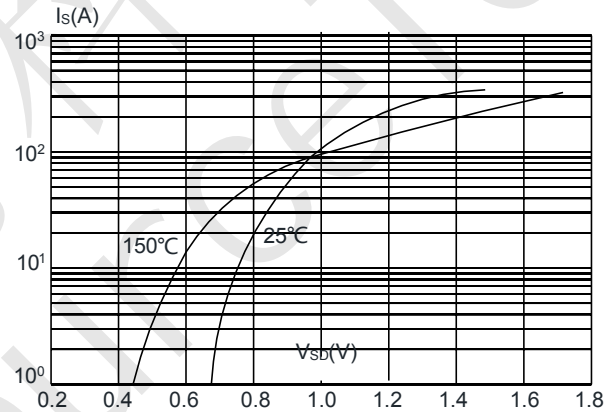

Figure 5: Gate Charge Characteristics

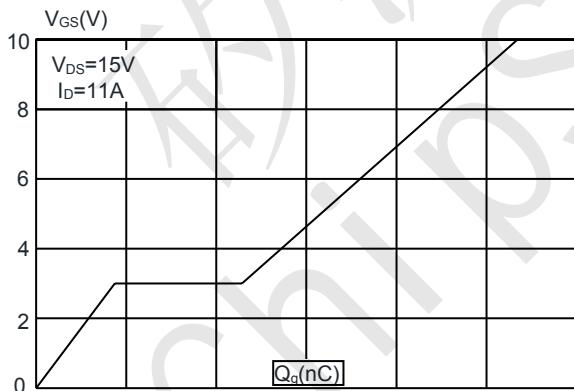
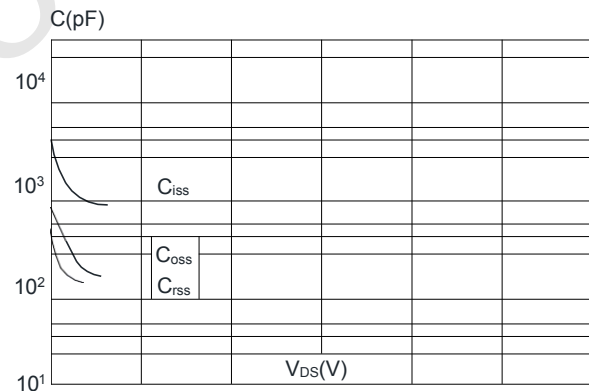

Figure 6: Capacitance Characteristics





CST302 Dual N-Ch 30V Fast Switching MOSFETs

Figure 7: Normalized Breakdown Voltage vs. Junction Temperature

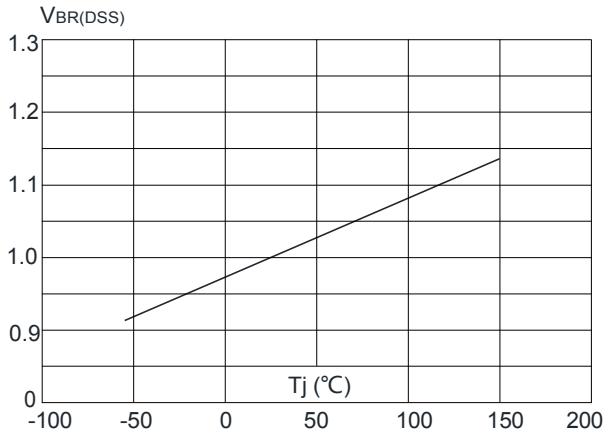

Figure 8: Normalized on Resistance vs. Junction Temperature

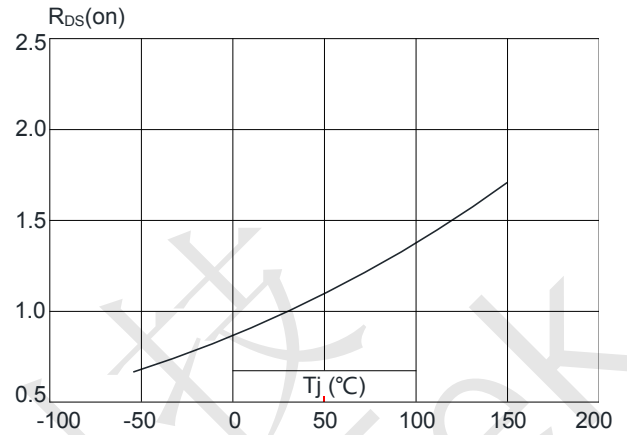

Figure 9: Maximum Safe Operating Area

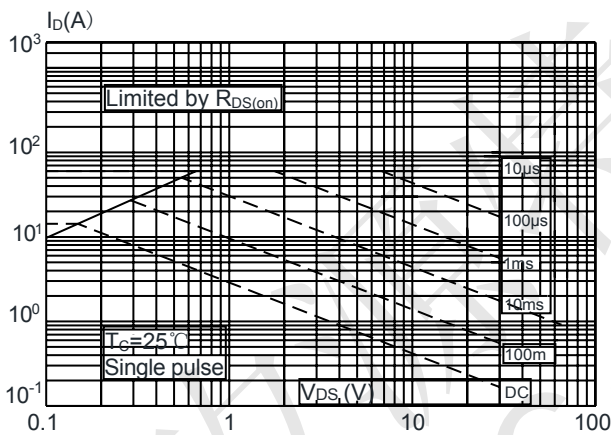

Figure 10: Maximum Continuous Drain Current vs. Case Temperature

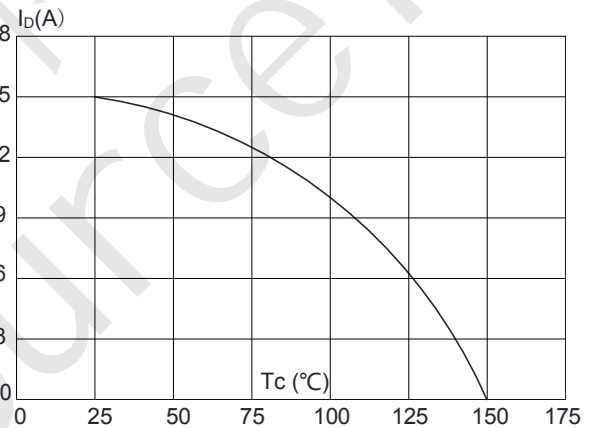
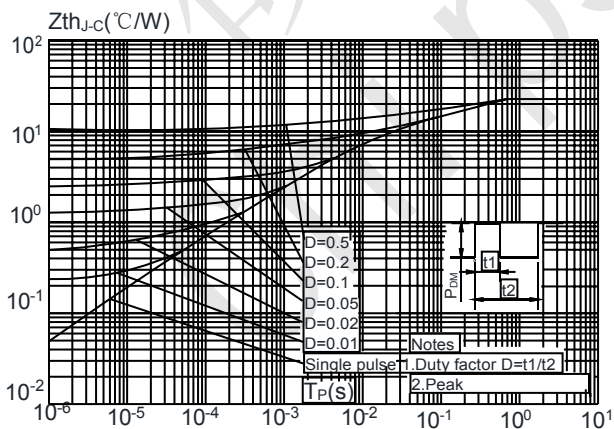
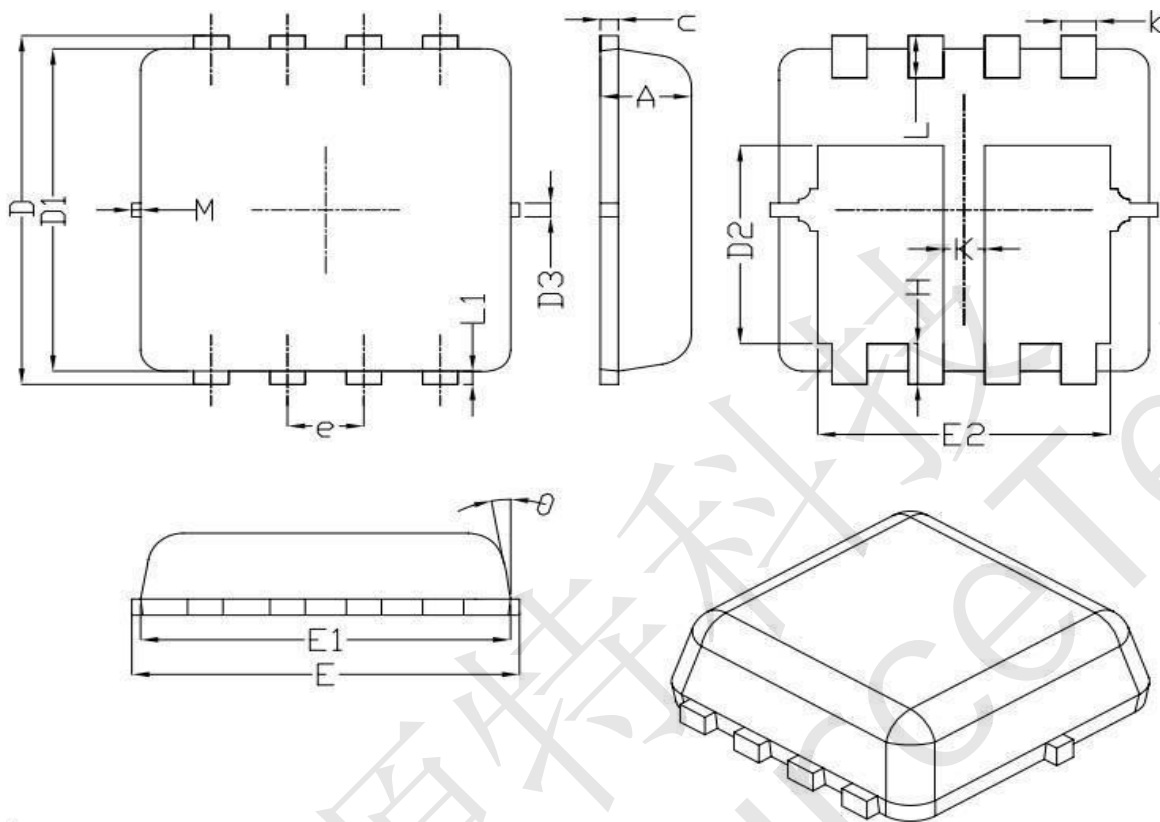

Figure 11: Maximum Effective Transient Thermal Impedance, Junction-to-Case





CST302 Dual PDFN3333-8L Package Outline Data



Symbol	Dimensions (unit: mm)		
	Min	Typ	Max
A	0.70	0.75	0.80
b	0.25	0.30	0.35
c	0.10	0.15	0.25
D	3.25	3.35	3.45
D1	3.00	3.10	3.20
D2	1.78	1.88	1.98
D3	--	0.13	--
E	3.20	3.30	3.40
E1	3.00	3.15	3.20
E2	2.39	2.49	2.59
e	0.65 BSC		
H	0.30	0.39	0.50
L	0.30	0.40	0.50
L1	--	0.13	--
K	0.30	--	--
θ	--	10°	12°
M	*	*	0.15
* Not Specified			

Notes:

1. Refer to JEDEC MO-240 variation CA.
2. Dimensions "D1" and "E1" do NOT include mold flash protrusions or gate burrs.
3. Dimensions "D1" and "E1" include interterminal flash or protrusion.