



CST30N03BD Product Summary

- ★ Green Device Available
- ★ Super Low Gate Charge
- ★ Excellent CdV/dt effect decline
- ★ Advanced high cell density Trench technology

BVDSS	RDSON	ID
30V	9.5 mΩ	25 A

CST30N03BD PDFN3333-8L Pin Configuration

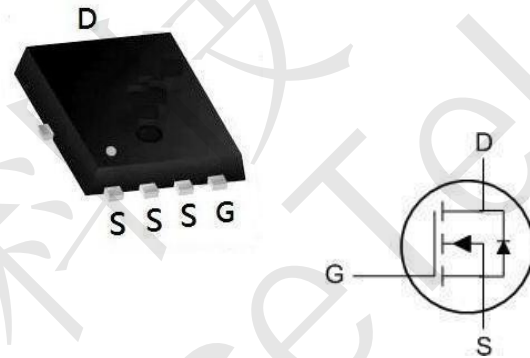

CST30N03BD Description

The CST30N03BD is the high cell density trenched N-ch MOSFETs, which provide excellent RDSON and gate charge for most of the synchronous buck converter applications. The CST30N03BD meet the RoHS and Green Product requirement, 100% EAS guaranteed with full function reliability approved.

CST30N03BD Absolute Maximum Ratings

Symbol	Parameter	Rating	Units
V_{DS}	Drain-Source Voltage	30	V
V_{GS}	Gate-Source Voltage	±20	V
$I_D@T_A=25^{\circ}C$	Continuous Drain Current, V_{GS} @ 10V ¹	25	A
$I_D@T_A=70^{\circ}C$	Continuous Drain Current, V_{GS} @ 10V ¹	10	A
I_{DM}	Pulsed Drain Current ²	90	A
EAS	Single Pulse Avalanche Energy ³	19	mJ
I_{AS}	Avalanche Current	25	A
$P_D@T_A=25^{\circ}C$	Total Power Dissipation ⁴	10	W
T_{STG}	Storage Temperature Range	-55 to 150	°C
T_J	Operating Junction Temperature Range	-55 to 150	°C

CST30N03BD Thermal Data

Symbol	Parameter	Typ.	Max.	Unit
$R_{\theta JA}$	Thermal Resistance Junction-ambient ¹	---	85	°C/W



Symbol	Parameter	Test Condition	Min.	Typ.	Max.	Units
Off Characteristic						
$V_{(BR)DSS}$	Drain-Source Breakdown Voltage	$V_{GS}=0V, I_D=250\mu A$	30	-	-	V
I_{DSS}	Zero Gate Voltage Drain Current	$V_{DS}=30V, V_{GS}=0V,$	-	-	1.0	μA
I_{GSS}	Gate to Body Leakage Current	$V_{DS}=0V, V_{GS}=\pm 20V$	-	-	± 100	nA
On Characteristics						
$V_{GS(th)}$	Gate Threshold Voltage	$V_{DS}=V_{GS}, I_D=250\mu A$	1.0	1.5	2.5	V
$R_{DS(on)}$	Static Drain-Source on-Resistance <small>note3</small>	$V_{GS}=10V, I_D=10A$	-	9.5	13	m Ω
		$V_{GS}=4.5V, I_D=5A$	-	16	22.5	
Dynamic Characteristics						
C_{iss}	Input Capacitance	$V_{DS}=15V, V_{GS}=0V,$ $f=1.0MHz$	-	633	-	pF
C_{oss}	Output Capacitance		-	120	-	pF
C_{rss}	Reverse Transfer Capacitance		-	99	-	pF
Q_g	Total Gate Charge	$V_{DS}=15V, I_D=10A,$ $V_{GS}=10V$	-	15	-	nC
Q_{gs}	Gate-Source Charge		-	4.7	-	nC
Q_{gd}	Gate-Drain("Miller") Charge		-	3.6	-	nC
Switching Characteristics						
$t_{d(on)}$	Turn-on Delay Time	$V_{DS}=30V, I_D=18A,$ $R_{GEN}=3\Omega, V_{GS}=10V$	-	5	-	ns
t_r	Turn-on Rise Time		-	8	-	ns
$t_{d(off)}$	Turn-off Delay Time		-	21	-	ns
t_f	Turn-off Fall Time		-	7	-	ns
Drain-Source Diode Characteristics and Maximum Ratings						
I_S	Maximum Continuous Drain to Source Diode Forward Current		-	-	18	A
I_{SM}	Maximum Pulsed Drain to Source Diode Forward Current		-	-	72	A
V_{SD}	Drain to Source Diode Forward Voltage	$V_{GS}=0V, I_S=18A$	-	-	1.2	V
t_{rr}	Body Diode Reverse Recovery Time	$I_F=18A, di/dt=100A/\mu s$	-	7	-	ns
Q_{rr}	Body Diode Reverse Recovery Charge		-	5.9	-	nC

Note :

1. The data tested by surface mounted on a 1 inch² FR-4 board with 2OZ copper.
2. The data tested by pulsed , pulse width $\leq 300\mu s$, duty cycle $\leq 2\%$
3. The EAS data shows Max. rating . The test condition is $V_{DD}=25V, V_{GS}=10V, L=0.1mH, I_{AS}=20A$
4. The power dissipation is limited by 150°C junction temperature
5. The data is theoretically the same as I_D and I_{DM} , in real applications , should be limited by total power dissipation.



CST30N03BD Typical Performance Characteristics

Figure 1: Output Characteristics

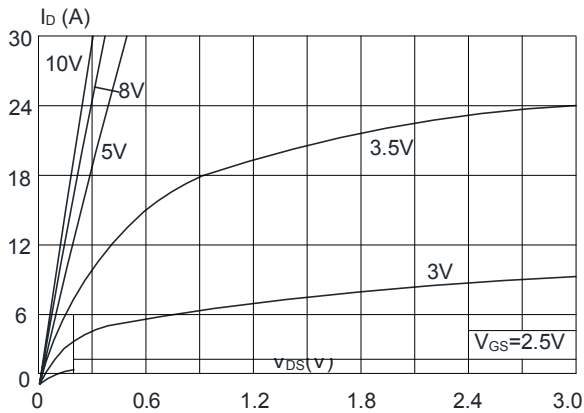

Figure 2: Typical Transfer Characteristics

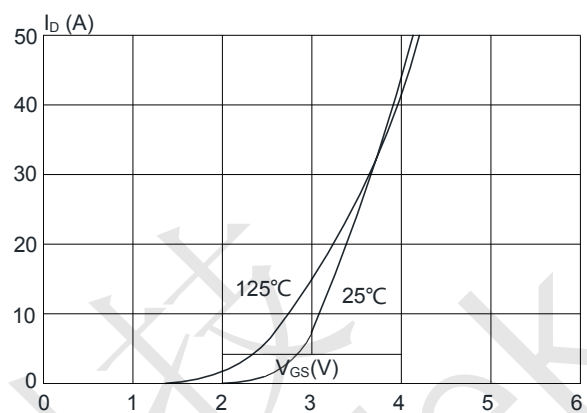

Figure 3: On-resistance vs. Drain Current

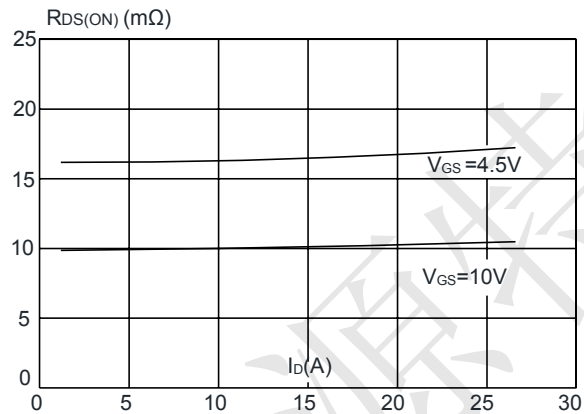

Figure 4: Body Diode Characteristics

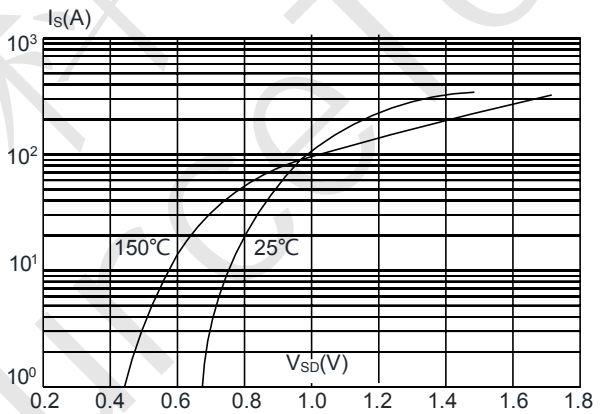

Figure 5: Gate Charge Characteristics

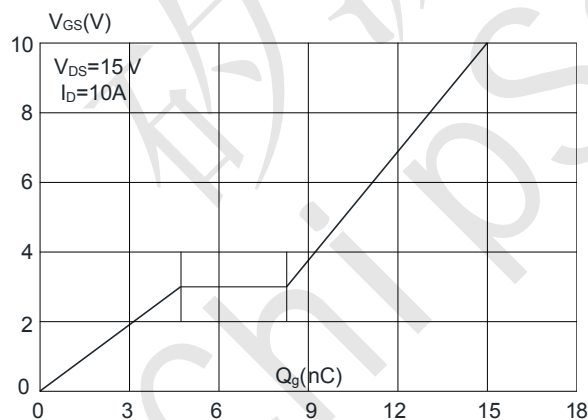

Figure 6: Capacitance Characteristics

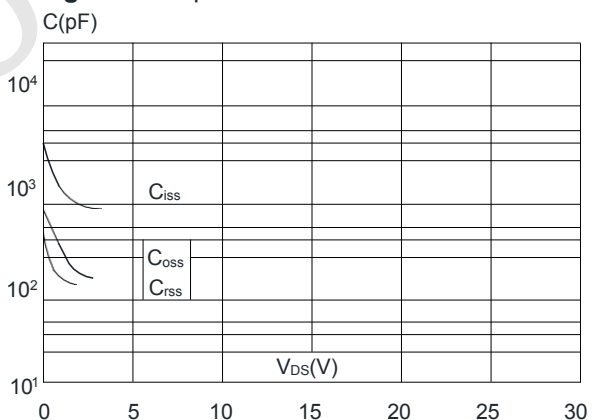



Figure 7: Normalized Breakdown Voltage vs. Junction Temperature

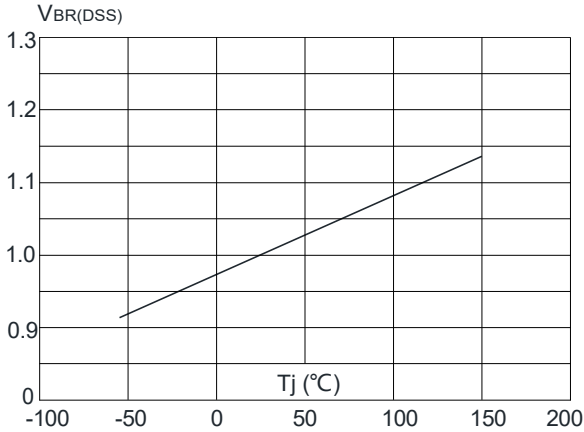

Figure 8: Normalized on Resistance vs. Junction Temperature

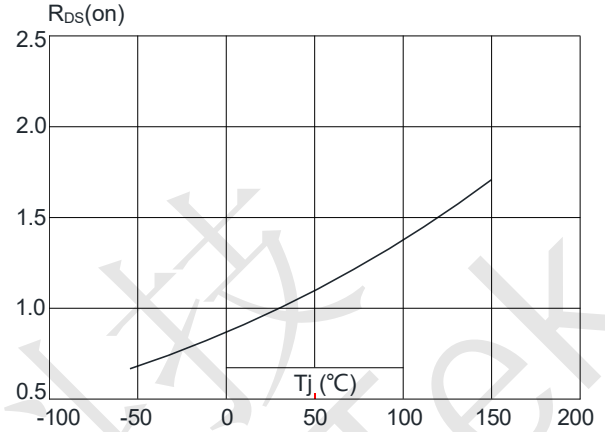

Figure 9: Maximum Safe Operating Area

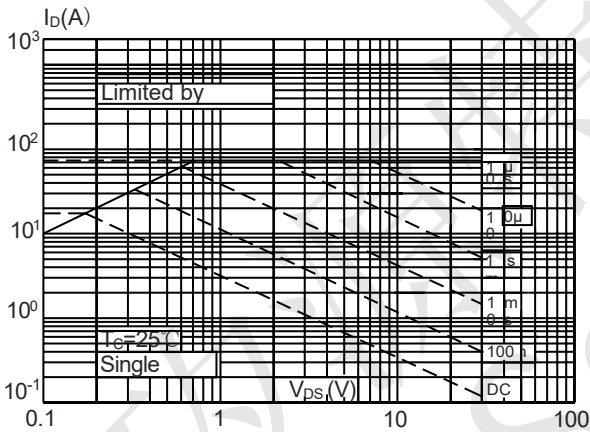

Figure 10: Maximum Continuous Drain Current vs. Case Temperature

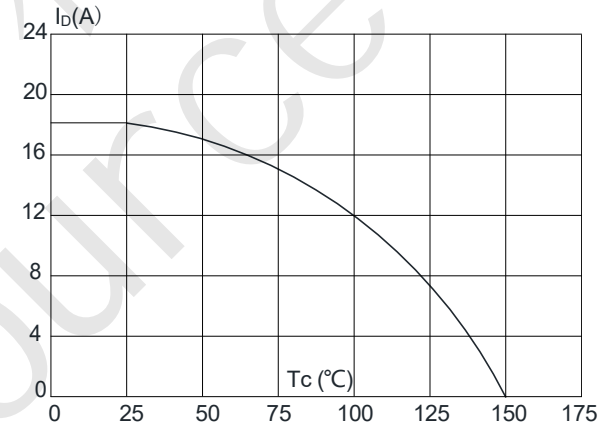
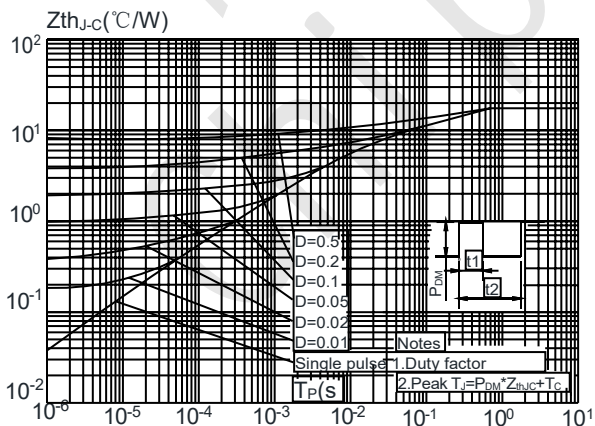

Figure.11: Maximum Effective Transient Thermal Impedance, Junction-to-Case





CST30N03BD Test Circuit

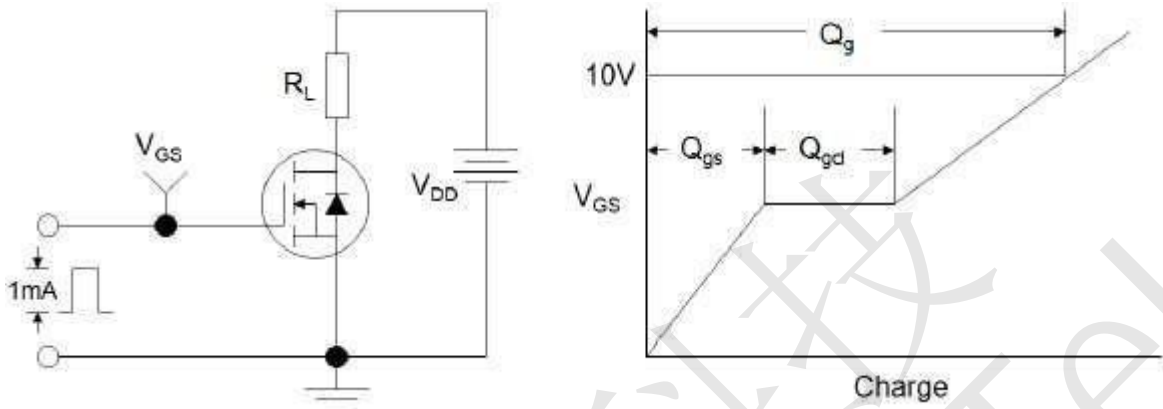

Figure1:Gate Charge Test Circuit & Waveform

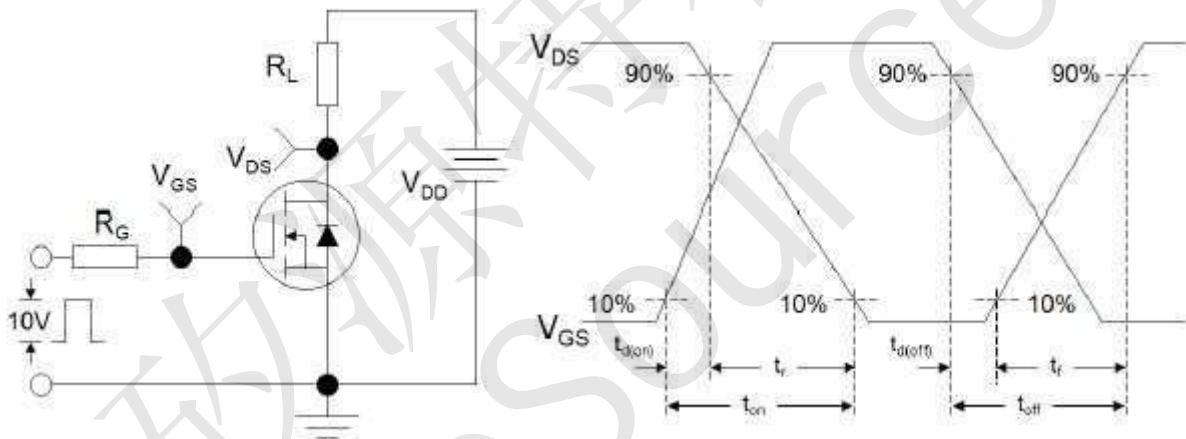

Figure 2: Resistive Switching Test Circuit & Waveforms

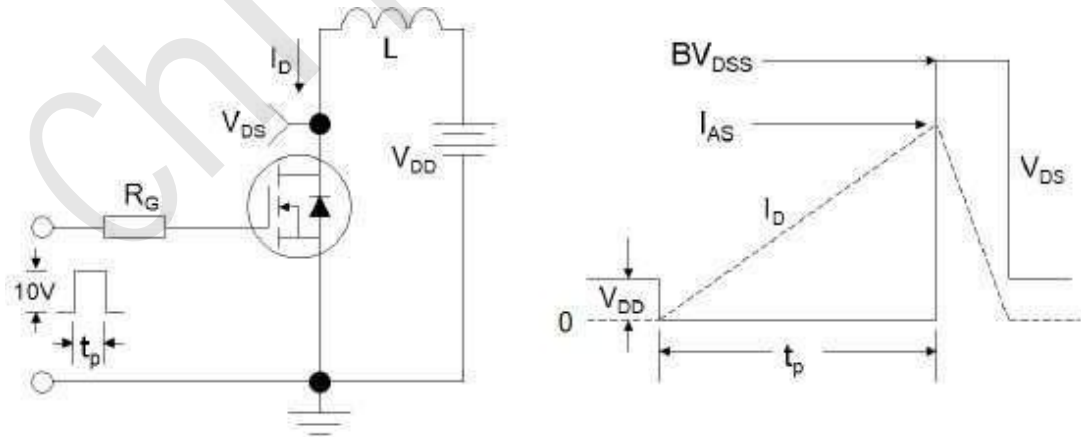
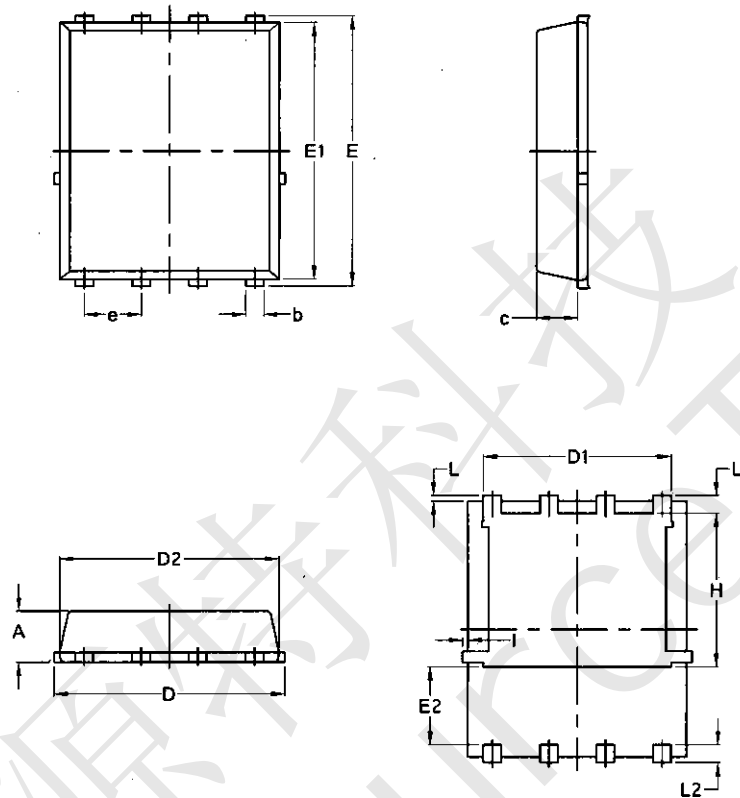

Figure 3:Unclamped Inductive Switching Test Circuit & Waveforms



CST30N03BD Package Mechanical Data-PDFN3333



COMMON DIMENSIONS

(UNITS OF MEASURE=MILLIMETER)

SYMBOL	MIN	NOM	MAX
A	0.70	0.80	0.90
A1	0.00	0.03	0.05
b	0.24	0.30	0.35
c	0.10	0.15	0.20
D	3.25	3.32	3.40
D1	3.05	3.15	3.25
D2	2.40	2.50	2.60
E	3.00	3.10	3.20
E1	1.35	1.45	1.55
e	0.65 BSC.		
H	3.20	3.30	3.40
L	0.30	0.40	0.50
L1	0.10	0.15	0.20
L2	1.13 REF.		