



CST30P02 P-Ch 18V Fast Switching MOSFETs

- ★ Green Device Available
- ★ Super Low Gate Charge
- ★ Excellent Cdv/dt effect decline
- ★ Advanced high cell density Trench technology

CST30P02 Product Summary



BVDSS	RDSON	ID
-18V	15mΩ	-25 A

CST30P02 Description

The CST30P02 is the high cell density trenched P-ch MOSFETs, which provide excellent RDSON and gate charge for most of the synchronous buck converter applications.

The CST30P02 meet the RoHS and Green

Product requirement 100% EAS guaranteed with full function reliability approved.

CST30P02 TO252 Pin Configuration

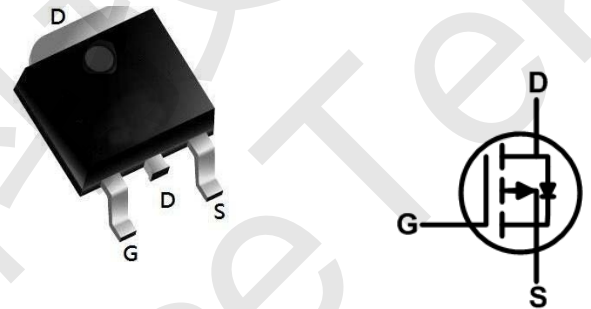

CST30P02 Absolute Maximum Ratings

Symbol	Parameter	Rating	Units
V_{DS}	Drain-Source Voltage	-18	V
V_{GS}	Gate-Source Voltage	± 12	V
$I_D@T_A=25^\circ\text{C}$	Continuous Drain Current, $V_{GS} @ -4.5\text{V}^1$	-25	A
$I_D@T_A=70^\circ\text{C}$	Continuous Drain Current, $V_{GS} @ -4.5\text{V}^1$	-15	A
I_{DM}	Pulsed Drain Current ²	-38	A
$P_D@T_A=25^\circ\text{C}$	Total Power Dissipation ³	3.9	W
T_{STG}	Storage Temperature Range	-55 to 150	$^\circ\text{C}$
T_J	Operating Junction Temperature Range	-55 to 150	$^\circ\text{C}$

CST30P02 Thermal Data

Symbol	Parameter	Typ.	Max.	Unit
$R_{\theta JA}$	Thermal Resistance Junction-ambient ¹	---	45	$^\circ\text{C}/\text{W}$
$R_{\theta JC}$	Thermal Resistance Junction-Case ¹	---	50	$^\circ\text{C}/\text{W}$



CST30P02 P-Ch 18V Fast Switching MOSFETs

CST30P02 Electrical Characteristics (T_J=25°C unless otherwise specified)

Symbol	Parameter	Test Condition	Min.	Typ.	Max.	Units
Off Characteristic						
V _{(BR)DSS}	Drain-Source Breakdown Voltage	V _{GS} =0V, I _D = -250μA	-15	-18	-	V
I _{DSS}	Zero Gate Voltage Drain Current	V _{DS} = -12V, V _{GS} =0V,	-	-	-1	μA
I _{GSS}	Gate to Body Leakage Current	V _{DS} =0V, V _{GS} = ±12V	-	-	±100	nA
On Characteristics						
V _{GS(th)}	Gate Threshold Voltage	V _{DS} =V _{GS} , I _D = -250μA	-0.4	-0.7	-1.0	V
R _{DS(on)}	Static Drain-Source on-Resistance <small>note2</small>	V _{GS} = -4.5V, I _D = -7A	-	15	25	mΩ
		V _{GS} = -2.5V, I _D = -5A	-	22	30	
Dynamic Characteristics						
C _{iss}	Input Capacitance	V _{DS} = -6V, V _{GS} =0V, f=1.0MHz	-	1300	-	pF
C _{oss}	Output Capacitance		-	302	-	pF
C _{rss}	Reverse Transfer Capacitance		-	279	-	pF
Q _g	Total Gate Charge	V _{DS} = -6V, I _D = -7A, V _{GS} = -4.5V	-	19	-	nC
Q _{gs}	Gate-Source Charge		-	4	-	nC
Q _{gd}	Gate-Drain("Miller") Charge		-	5	-	nC
Switching Characteristics						
t _{d(on)}	Turn-on Delay Time	V _{DD} = -6V, I _D = -4A, V _{GS} = -4.5V, R _{GEN} =2.5Ω	-	11	-	ns
t _r	Turn-on Rise Time		-	36	-	ns
t _{d(off)}	Turn-off Delay Time		-	29	-	ns
t _f	Turn-off Fall Time		-	8	-	ns
Drain-Source Diode Characteristics and Maximum Ratings						
I _S	Maximum Continuous Drain to Source Diode Forward Current		-	-	-25	A
I _{SM}	Maximum Pulsed Drain to Source Diode Forward Current		-	-	-38	A
V _{SD}	Drain to Source Diode Forward Voltage	V _{GS} =0V, I _S = -7A	-	-0.8	-1.2	V

Notes:1. Repetitive Rating: Pulse Width Limited by Maximum Junction Temperature

2. Pulse Test: Pulse Width≤300μs, Duty Cycle≤2%



CST30P02 Typical Performance Characteristics

Figure 1: Output Characteristics

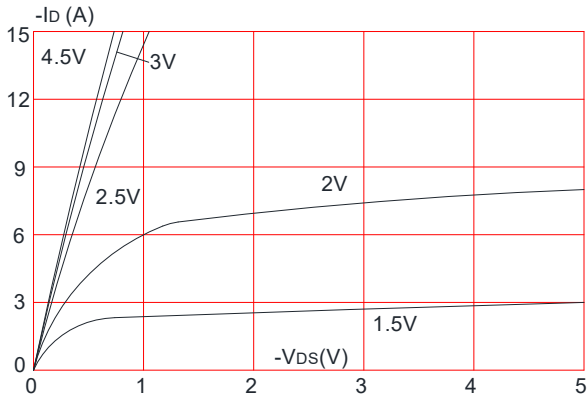

Figure 2: Typical Transfer Characteristics

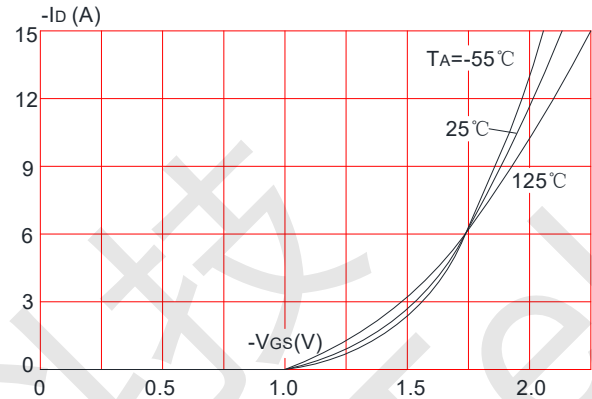

Figure 3: On-resistance vs. Drain Current

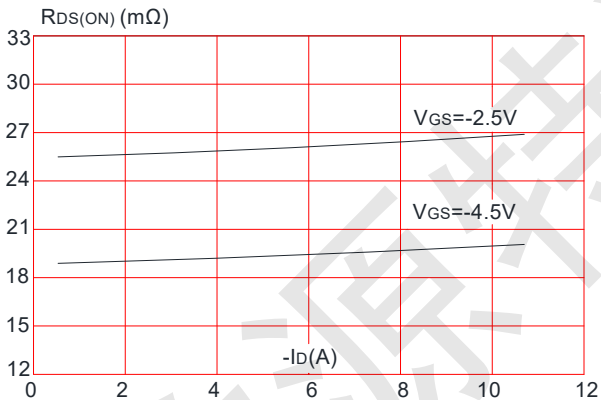

Figure 4: Body Diode Characteristics

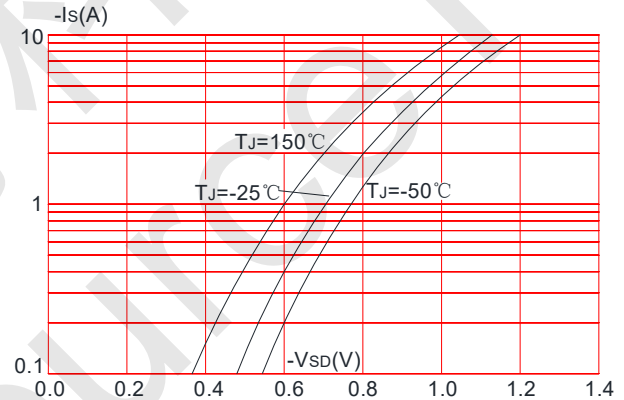

Figure 5: Gate Charge Characteristics

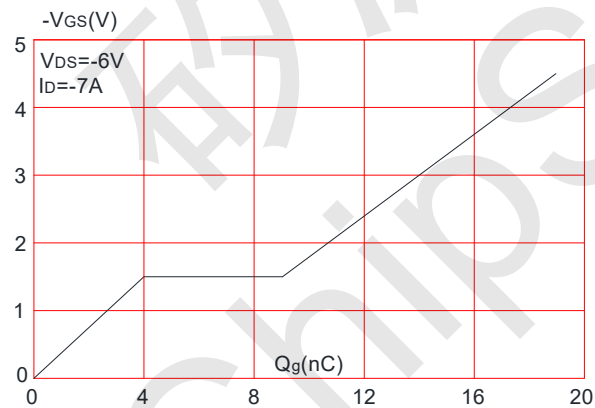
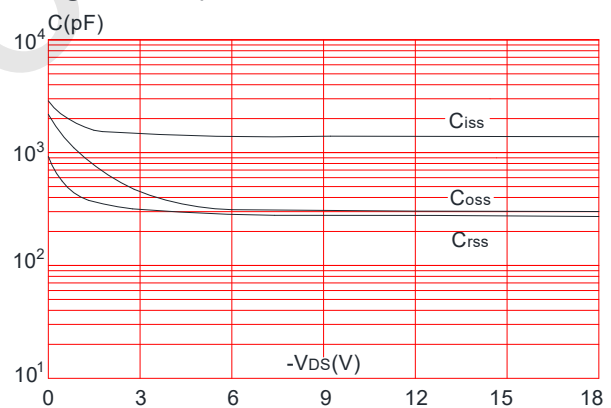

Figure 6: Capacitance Characteristics





CST30P02 P-Ch 18V Fast Switching MOSFETs

Figure 7: Normalized Breakdown Voltage vs. Junction Temperature

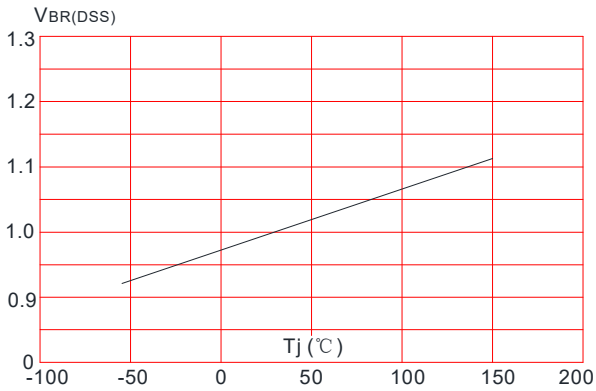

Figure 8: Normalized on Resistance vs. Junction Temperature

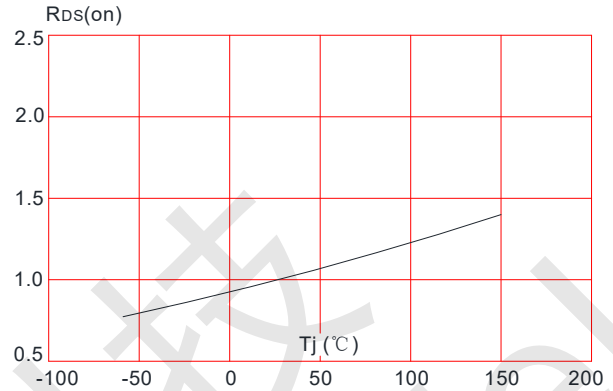

Figure 9: Maximum Safe Operating Area

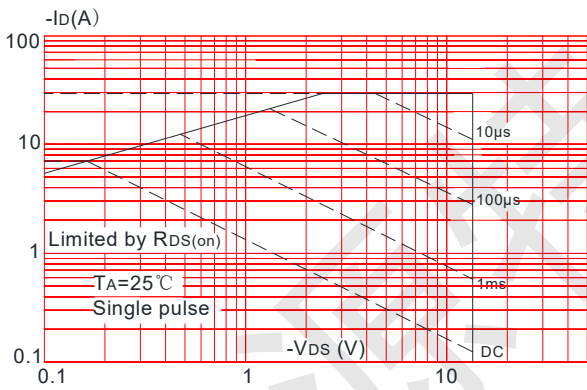

Figure 10: Maximum Continuous Drain Current vs. Ambient Temperature

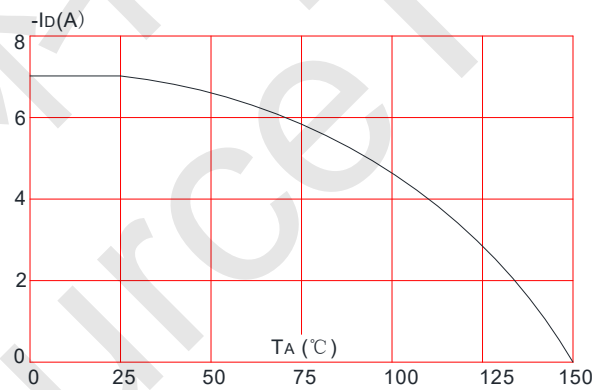
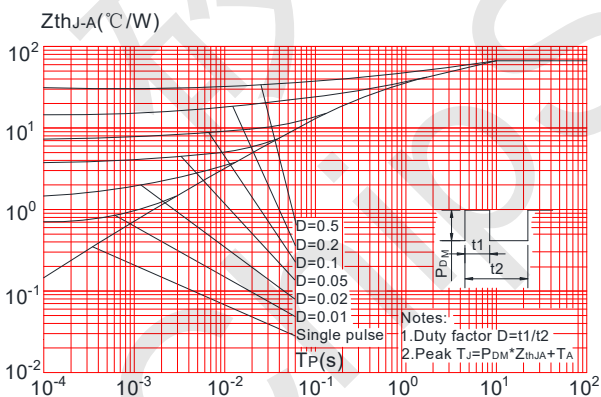
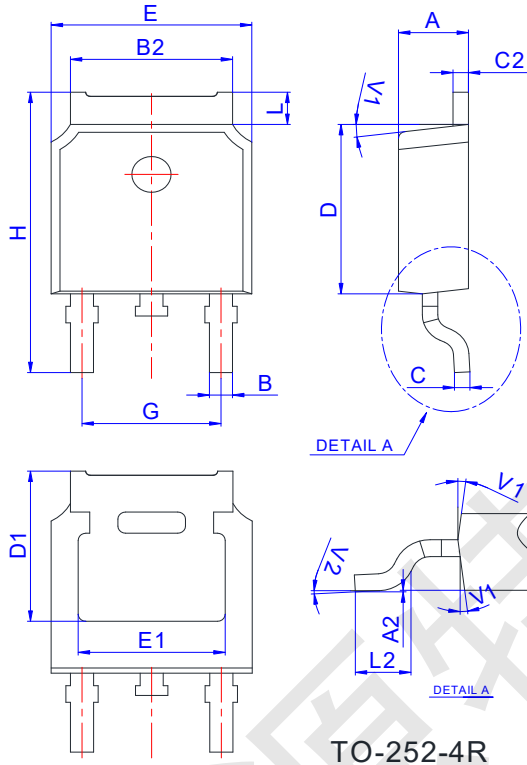

Figure.11: Maximum Effective Transient Thermal Impedance, Junction-to-Ambient





CST30P02 Package Mechanical Data-TO-252-4R



Ref.	Dimensions					
	Millimeters			Inches		
	Min.	Typ.	Max.	Min.	Typ.	Max.
A	2.10		2.50	0.083		0.098
A2	0		0.10	0		0.004
B	0.66		0.86	0.026		0.034
B2	5.18		5.48	0.202		0.216
C	0.40		0.60	0.016		0.024
C2	0.44		0.58	0.017		0.023
D	5.90		6.30	0.232		0.248
D1	5.30REF			0.209REF		
E	6.40		6.80	0.252		0.268
E1	4.63			0.182		
G	4.47		4.67	0.176		0.184
H	9.50		10.70	0.374		0.421
L	1.09		1.21	0.043		0.048
L2	1.35		1.65	0.053		0.065
V1		7°			7°	
V2	0°		6°	0°		6°

Reel Specification-TO-252-4R

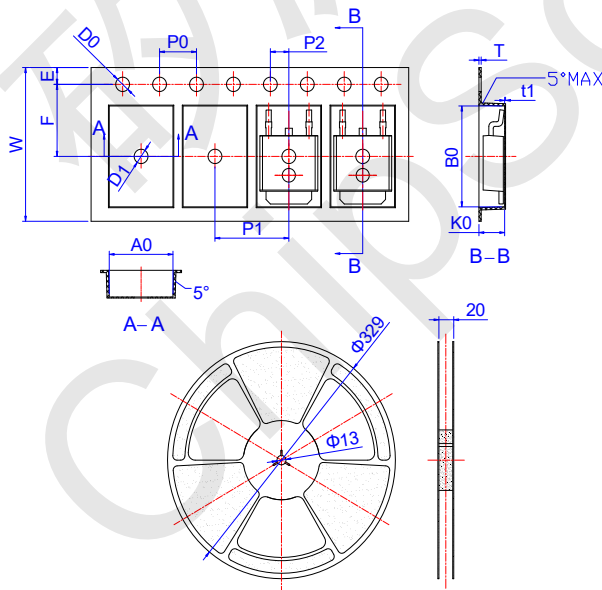

Ref.	Dimensions					
	Millimeters			Inches		
	Min.	Typ.	Max.	Min.	Typ.	Max.
W	15.90	16.00	16.10	0.626	0.630	0.634
E	1.65	1.75	1.85	0.065	0.069	0.073
F	7.40	7.50	7.60	0.291	0.295	0.299
D0	1.40	1.50	1.60	0.055	0.059	0.063
D1	1.40	1.50	1.60	0.055	0.059	0.063
P0	3.90	4.00	4.10	0.154	0.157	0.161
P1	7.90	8.00	8.10	0.311	0.315	0.319
P2	1.90	2.00	2.10	0.075	0.079	0.083
A0	6.85	6.90	7.00	0.270	0.271	0.276
B0	10.45	10.50	10.60	0.411	0.413	0.417
K0	2.68	2.78	2.88	0.105	0.109	0.113
T	0.24		0.27	0.009		0.011
t1	0.10			0.004		
10P0	39.80	40.00	40.20	1.567	1.575	1.583