



CST30P06F P-Ch 60V Fast Switching MOSFETs

- ★ 100% EAS Guaranteed
- ★ Green Device Available
- ★ Super Low Gate Charge
- ★ Excellent CdV/dt effect decline
- ★ Advanced high cell density Trench technology

CST30P06F Product Summary



BVDSS	RDSON	ID
-60V	24mΩ	-30A

CST30P06F Description

The CST30P06F is the high cell density trenched P-ch MOSFETs, which provide excellent RDSON and gate charge for most of the synchronous buck converter applications.

The CST30P06F meet the RoHS and Green Product requirement, 100% EAS guaranteed with full function reliability approved.

CST30P06F PDFN5060-8L Pin Configuration

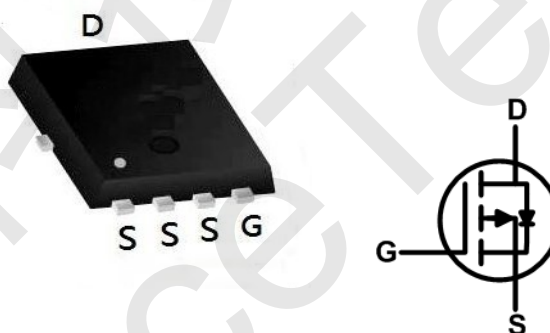

Table 1. Absolute Maximum Ratings (T_A=25°C unless otherwise noted)

Symbol	Parameter	Limit	Unit
V _{DS}	Drain-Source Voltage (V _{GS} =0V)	-60	V
V _{GS}	Gate-Source Voltage (V _{DS} =0V)	±20	V
I _D	Drain Current-Continuous(T _C =25°C)	-30	A
	Drain Current-Continuous(T _C =100°C)	-25.5	A
I _{DM (pluse)}	Drain Current-Continuous@ Current-Pulsed (Note 1)	-144	A
P _D	Maximum Power Dissipation(T _C =25°C)	79	W
	Maximum Power Dissipation(T _C =100°C)	39.5	W
E _{AS}	Avalanche energy (Note 2)	196	mJ
T _J , T _{STG}	Operating Junction and Storage Temperature Range	-55 To 175	°C

Table 2. Thermal Characteristic

Symbol	Parameter	Typ	Max	Unit
R _{θJC}	Thermal Resistance, Junction-to-Case		1.9	°C/W



Table 3. Electrical Characteristics (T_J=25°C unless otherwise noted)

Symbol	Parameter	Conditions	Min	Typ	Max	Unit
On/Off States						
B _V DSS	Drain-Source Breakdown Voltage	V _{GS} =0V I _D =-250μA	-60			V
I _{DSS}	Zero Gate Voltage Drain Current	V _{DS} =-60V, V _{GS} =0V			-1	μA
I _{GSS}	Gate-Body Leakage Current	V _{GS} =±20V, V _{DS} =0V			±100	nA
V _{GS(th)}	Gate Threshold Voltage	V _{DS} =V _{GS} , I _D =-250μA	-1	-1.8	-2.5	V
g _{FS}	Forward Transconductance	V _{DS} =-5V, I _D =-15A		35		S
R _{DS(ON)}	Drain-Source On-State Resistance	V _{GS} =-10V, I _D =-15A		24	30	mΩ
		V _{GS} =-4.5V, I _D =-10A		30	40	mΩ
Dynamic Characteristics						
C _{iss}	Input Capacitance	V _{DS} =-25V, V _{GS} =0V, f=1.0MHz		4026		pF
C _{oss}	Output Capacitance			134		pF
C _{rss}	Reverse Transfer Capacitance			98		pF
Switching Parameters						
t _{d(on)}	Turn-on Delay Time	V _{GS} =-10V, V _{DS} =-30V, R _L =1.5Ω, R _{GEN} =3Ω		12.2		nS
t _r	Turn-on Rise Time			10		nS
t _{d(off)}	Turn-Off Delay Time			64		nS
t _f	Turn-Off Fall Time			14		nS
Q _g	Total Gate Charge	V _{GS} =-10V, V _{DS} =-30V, I _D =-20A		68		nC
Q _{gs}	Gate-Source Charge			10.5		nC
Q _{gd}	Gate-Drain Charge			13		nC
Source-Drain Diode Characteristics						
I _{SD}	Source-Drain Current (Body Diode)				30	A
V _{SD}	Forward on Voltage (Note 3)	V _{GS} =0V, I _S =-15A			-1.2	V
t _{rr}	Reverse Recovery Time	I _F =-20A, di/dt=100A/μs		26		ns
Q _{rr}	Reverse Recovery Charge	I _F =-20A, di/dt=100A/μs		29		nC

Notes 1.Repetitive Rating: Pulse width limited by maximum junction temperature.

Notes 2.E_{AS} condition: T_J=25°C, V_{DD}=40V, V_G=-10V, R_g=25Ω, L=0.5mH.

Notes 3.Repetitive Rating: Pulse width limited by maximum junction temperature.



CST30P06F Typical Electrical And Thermal Characteristics (Curves)

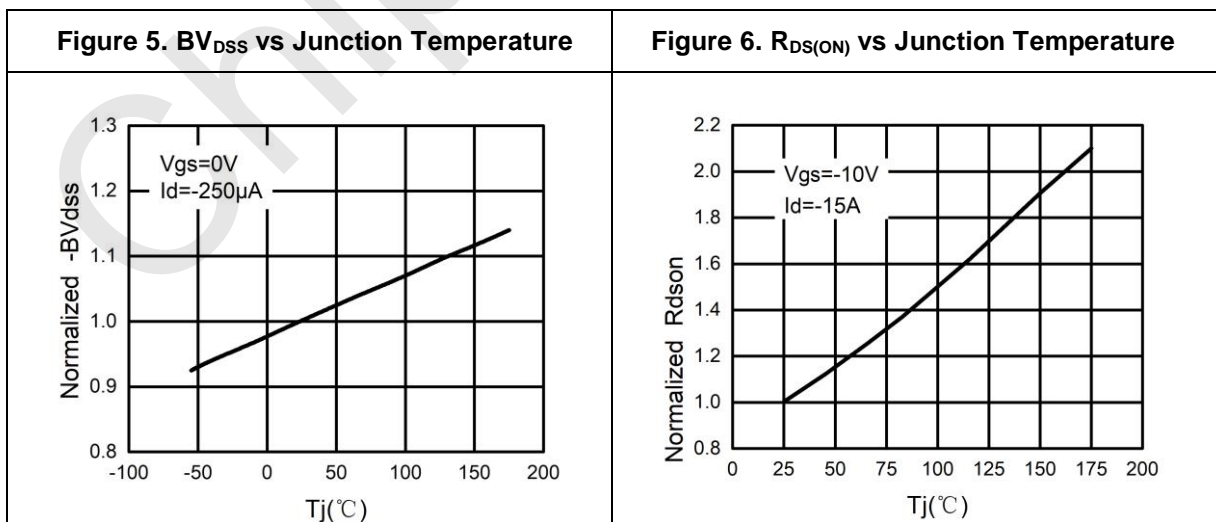
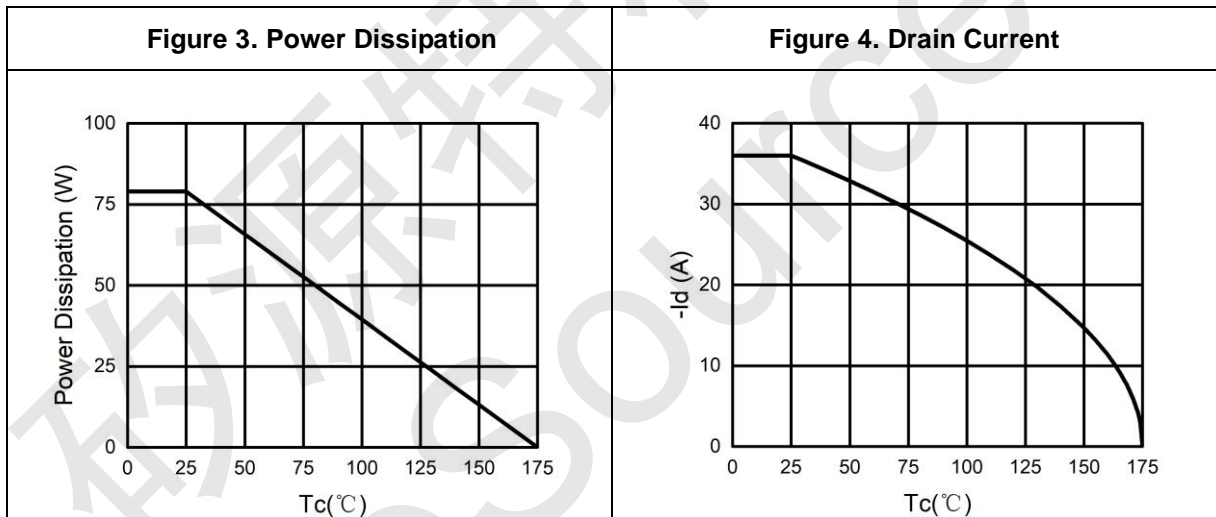
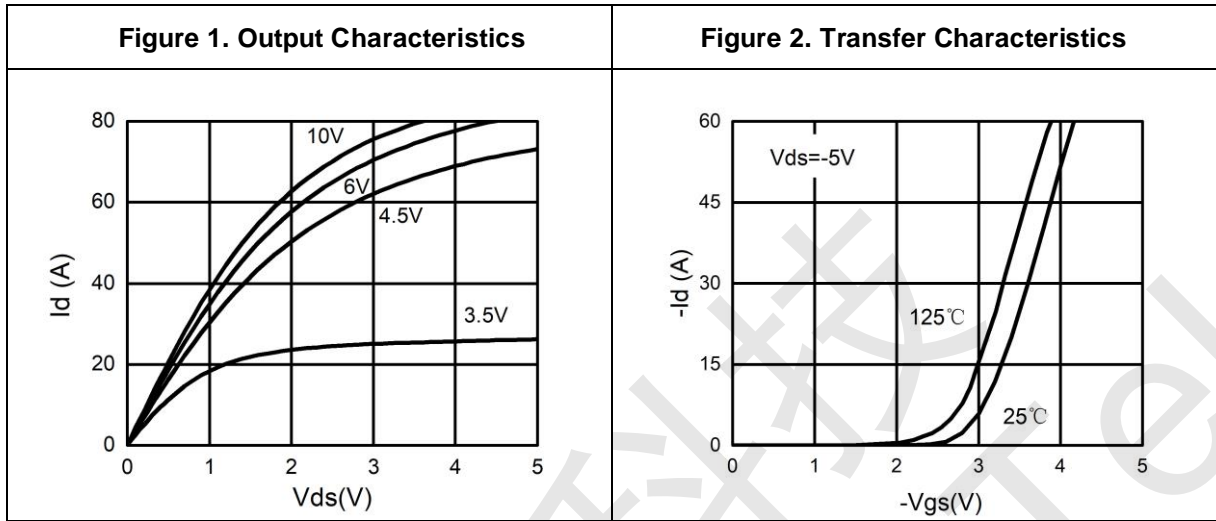



Figure 7. Gate Charge Waveforms

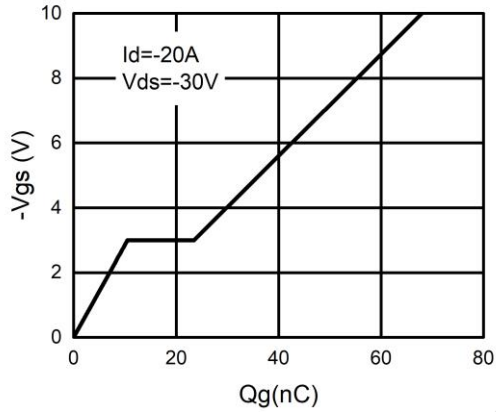

Figure 8. Capacitance

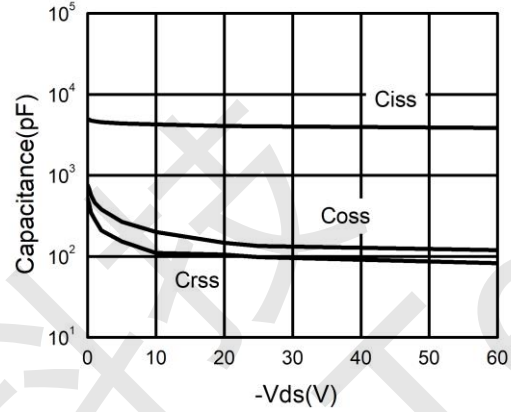

Figure 9. Body-Diode Characteristics

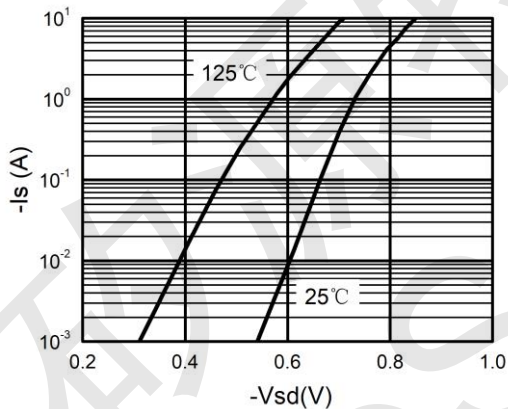
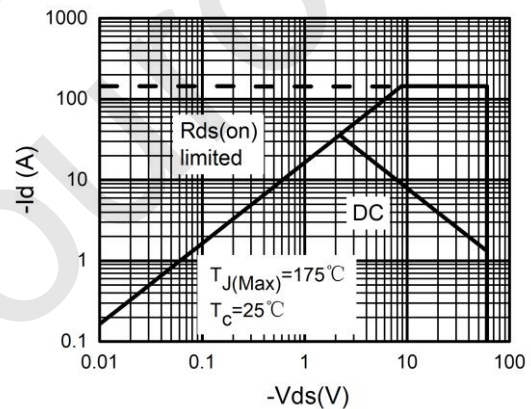
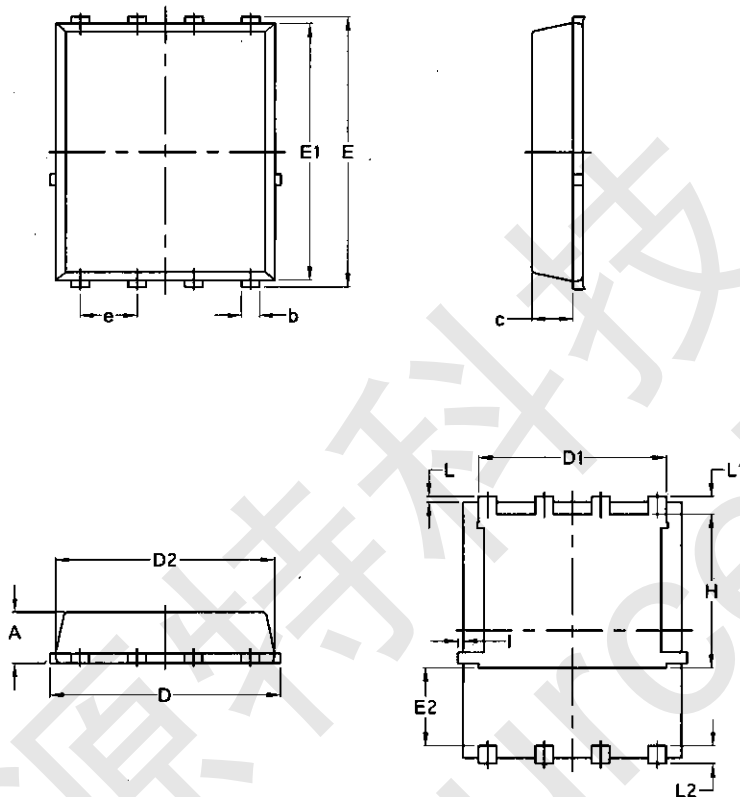

Figure 10. Maximum Safe Operating Area





CST30P06F Package Mechanical Data-PDFN5060-8L-JQ Single



Symbol	Common			
	mm		Inch	
	Mim	Max	Min	Max
A	1.03	1.17	0.0406	0.0461
b	0.34	0.48	0.0134	0.0189
c	0.824	0.0970	0.0324	0.082
D	4.80	5.40	0.1890	0.2126
D1	4.11	4.31	0.1618	0.1697
D2	4.80	5.00	0.1890	0.1969
E	5.95	6.15	0.2343	0.2421
E1	5.65	5.85	0.2224	0.2303
E2	1.60	/	0.0630	/
e	1.27 BSC		0.05 BSC	
L	0.05	0.25	0.0020	0.0098
L1	0.38	0.50	0.0150	0.0197
L2	0.38	0.50	0.0150	0.0197
H	3.30	3.50	0.1299	0.1378
I	/	0.18	/	0.0070