



CST3402 N-Ch 30V Fast Switching MOSFETs



- ★ Green Device Available
- ★ Super Low Gate Charge
- ★ Excellent Cdv/dt effect decline
- ★ Advanced high cell density Trench technology

CST3402 Product Summary

BVDSS	RDSON	ID
30V	32mΩ	4.5A

CST3402 Description

The CST3402 is the high cell density trenched N-ch MOSFETs, which provides excellent RDSON and efficiency for most of the small power switching and load switch applications.

The CST3402 meet the RoHS and Green Product requirement with full function reliability approved.

CST3402 SOT23 Pin Configuration

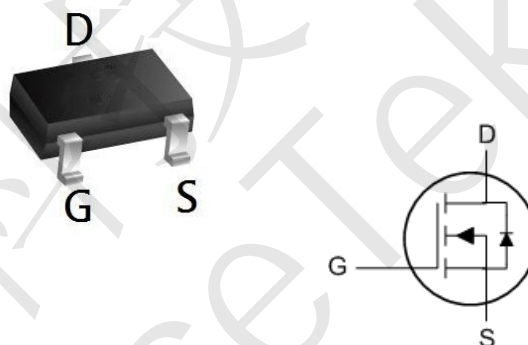

CST3402 Absolute Maximum Ratings

Symbol	Parameter	Rating	Units
V_{DS}	Drain-Source Voltage	30	V
V_{GS}	Gate-Source Voltage	± 12	V
$I_D @ T_A = 25^\circ C$	Continuous Drain Current, $V_{GS} @ 4.5V^1$	4.5	A
$I_D @ T_A = 70^\circ C$	Continuous Drain Current, $V_{GS} @ 4.5V^1$	2.8	A
I_{DM}	Pulsed Drain Current ²	16.4	A
$P_D @ T_A = 25^\circ C$	Total Power Dissipation ³	1.1	W
T_{STG}	Storage Temperature Range	-55 to 150	$^\circ C$
T_J	Operating Junction Temperature Range	-55 to 150	$^\circ C$

CST3402 Thermal Data

Symbol	Parameter	Typ.	Max.	Unit
$R_{\theta JA}$	Thermal Resistance Junction-ambient ¹	---	113	$^\circ C/W$
$R_{\theta JC}$	Thermal Resistance Junction-Case ¹	---	---	$^\circ C/W$



CST3402 N-Ch 30V Fast Switching MOSFETs

CST3402 Electrical Characteristics (T_J=25°C unless otherwise specified)

Symbol	Parameter	Test Condition	Min.	Typ.	Max.	Units
Off Characteristic						
V _{(BR)DSS}	Drain-Source Breakdown Voltage	V _{GS} =0V, I _D =250μA	30	-	-	V
I _{DSS}	Zero Gate Voltage Drain Current	V _{DS} =30V, V _{GS} =0V,	-	-	1.0	μA
I _{GSS}	Gate to Body Leakage Current	V _{DS} =0V, V _{GS} = ±12V	-	-	±100	nA
On Characteristics						
V _{GS(th)}	Gate Threshold Voltage	V _{DS} =V _{GS} , I _D =250μA	0.5	0.9	1.4	V
R _{DS(on)}	Static Drain-Source on-Resistance note2	V _{GS} =10V, I _D =4A	-	32	42	mΩ
		V _{GS} =4.5V, I _D =3A	-	36	48	
		V _{GS} =2.5V, I _D =2A	-	50	70	
Dynamic Characteristics						
C _{iss}	Input Capacitance	V _{DS} =15V, V _{GS} =0V, f=1.0MHz	-	285	-	pF
C _{oss}	Output Capacitance		-	33	-	pF
C _{rss}	Reverse Transfer Capacitance		-	27	-	pF
Q _g	Total Gate Charge	V _{DS} =15V, I _D =4A, V _{GS} =4.5V	-	2.6	-	nC
Q _{gs}	Gate-Source Charge		-	0.6	-	nC
Q _{gd}	Gate-Drain("Miller") Charge		-	0.9	-	nC
Switching Characteristics						
t _{d(on)}	Turn-on Delay Time	V _{DS} =15V, I _D =2A, R _{GEN} =3Ω, V _{GS} =4.5V	-	15	-	ns
t _r	Turn-on Rise Time		-	42	-	ns
t _{d(off)}	Turn-off Delay Time		-	16	-	ns
t _f	Turn-off Fall Time		-	10	-	ns
Drain-Source Diode Characteristics and Maximum Ratings						
I _S	Maximum Continuous Drain to Source Diode Forward Current		-	-	4.5	A
I _{SM}	Maximum Pulsed Drain to Source Diode Forward Current		-	-	16	A
V _{SD}	Drain to Source Diode Forward Voltage	V _{GS} =0V, I _S =4A	-	-	1.2	V

Notes:1. Repetitive Rating: Pulse Width Limited by Maximum Junction Temperature

2. Pulse Test: Pulse Width≤300μs, Duty Cycle≤0.5%



CST3402 Typical Performance Characteristics

Figure 1: Output Characteristics

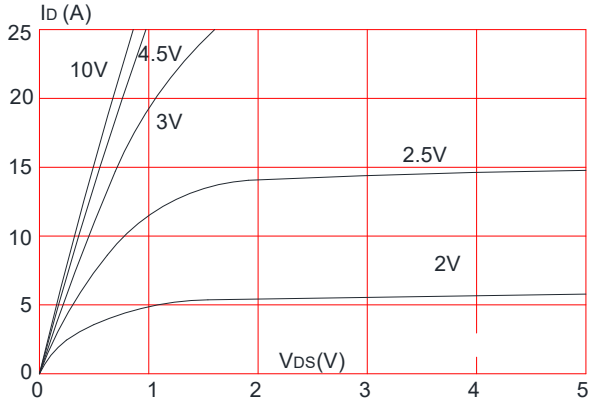

Figure 2: Typical Transfer Characteristics

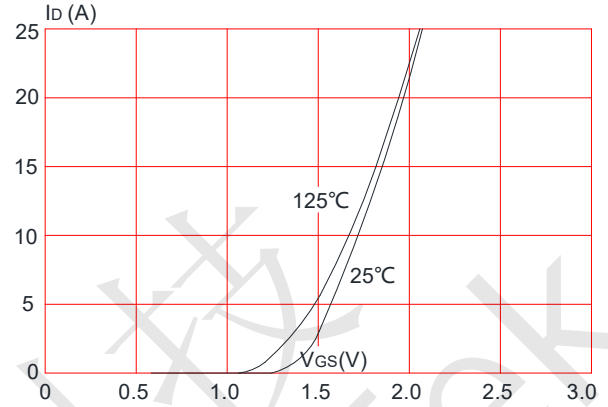

Figure 3: On-resistance vs. Drain Current

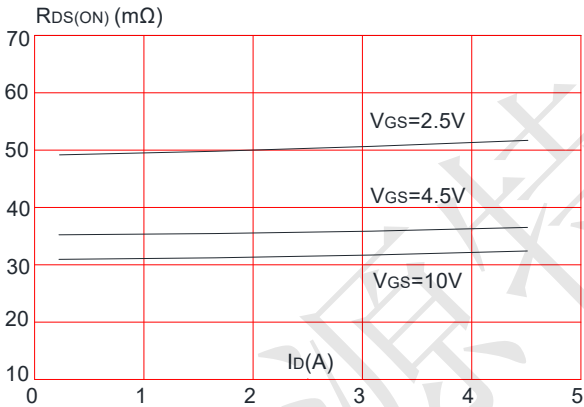

Figure 4: Body Diode Characteristics

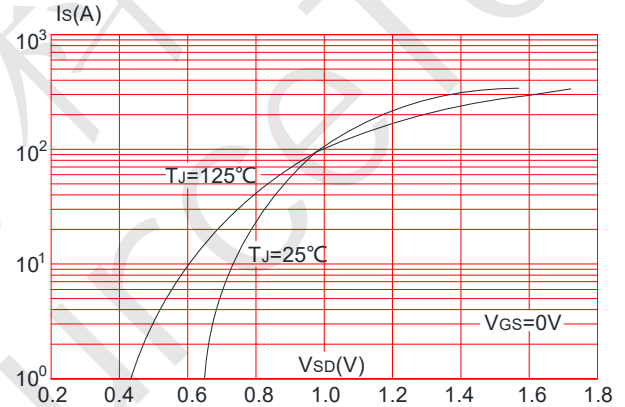

Figure 5: Gate Charge Characteristics

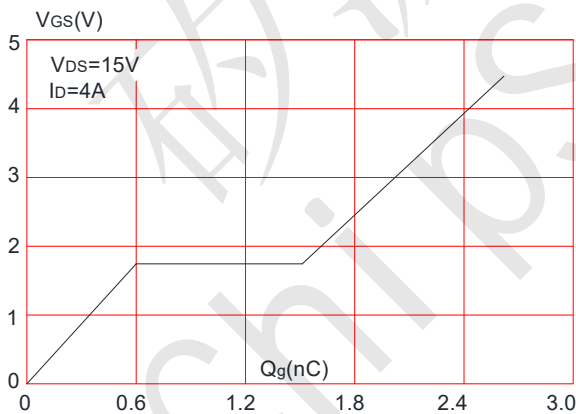
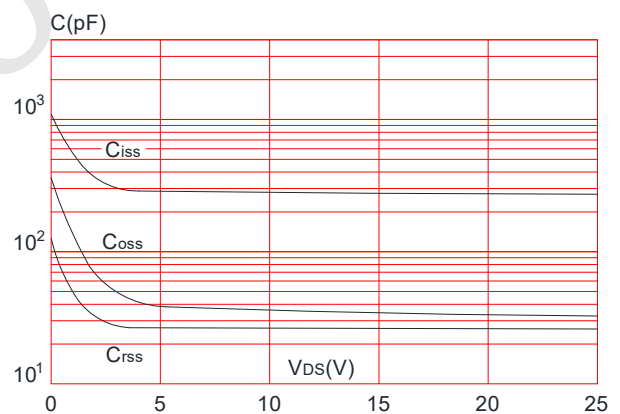

Figure 6: Capacitance Characteristics





CST3402 N-Ch 30V Fast Switching MOSFETs

Figure 7: Normalized Breakdown Voltage vs. Junction Temperature

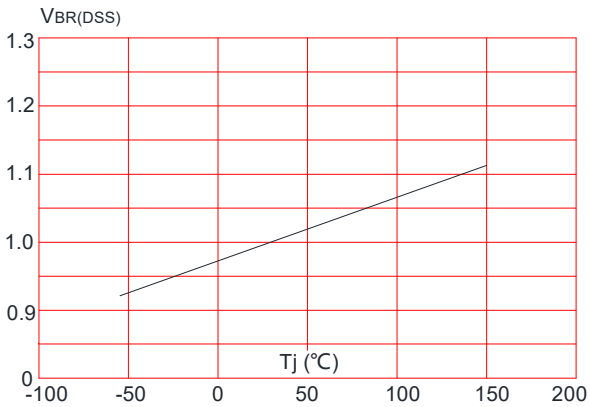

Figure 8: Normalized on Resistance vs. Junction Temperature

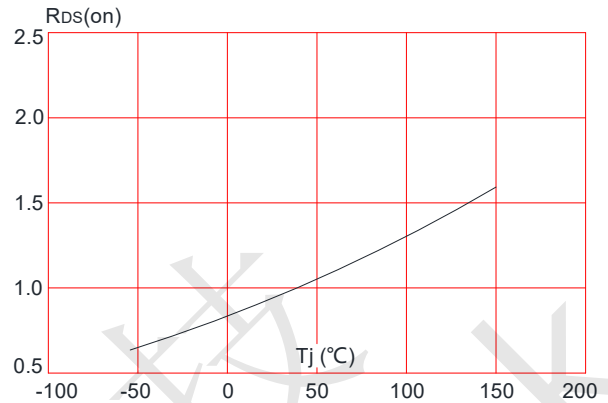

Figure 9: Maximum Safe Operating Area

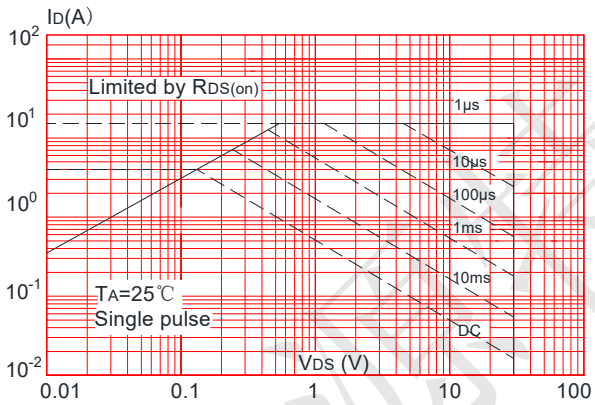

Figure 10: Maximum Continuous Drain Current vs. Ambient Temperature

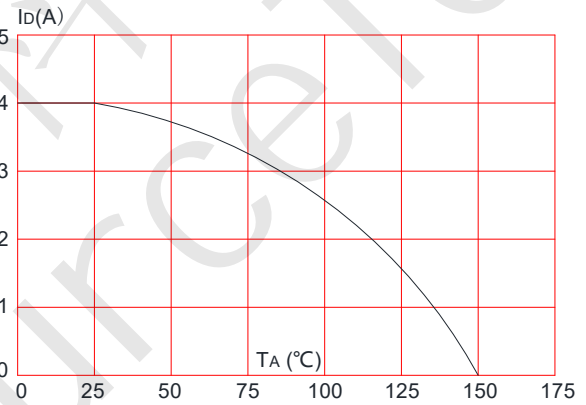
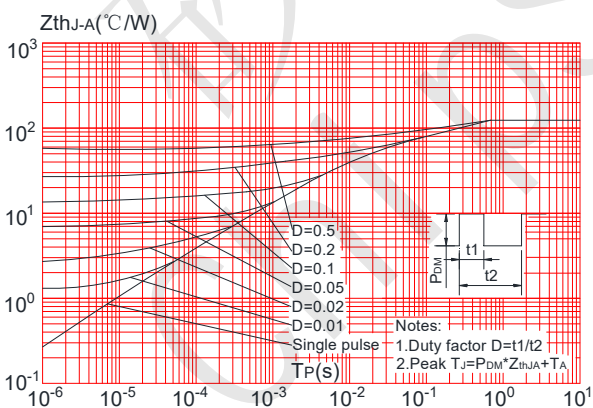
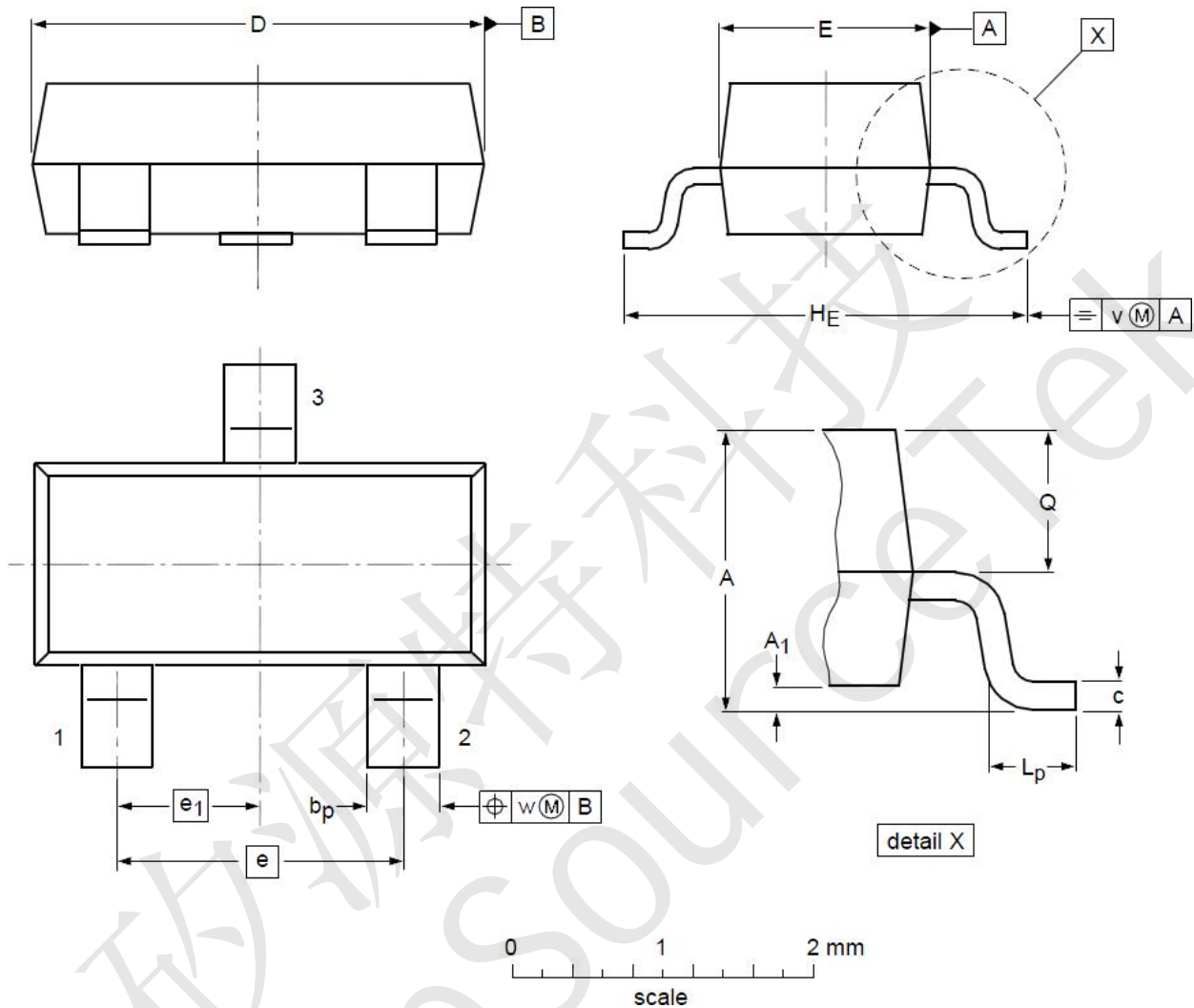

Figure 11: Maximum Effective Transient Thermal Impedance, Junction-to-Ambient





CST3402 Package Mechanical Data-SOT-23



DIMENSIONS (unit : mm)

Symbol	Min	Typ	Max	Symbol	Min	Typ	Max
A	0.90	1.01	1.15	A ₁	0.01	0.05	0.10
b _p	0.30	0.42	0.50	c	0.08	0.13	0.15
D	2.80	2.92	3.00	E	1.20	1.33	1.40
e	--	1.90	--	e ₁	--	0.95	--
H _E	2.25	2.40	2.55	L _p	0.30	0.42	0.50
Q	0.45	0.49	0.55	v	--	0.20	--
w	--	0.10	--				