



CST3407A P-Ch 30V Fast Switching MOSFETs

- ★ Green Device Available
- ★ Super Low Gate Charge
- ★ Excellent CdV/dt effect decline
- ★ Advanced high cell density Trench technology



CST3407A Product Summary

BVDSS	R _{DS(on)}	ID
-30V	42mΩ	-4.5A

CST3407A Description

The CST3407A is the high cell density trenched P-ch MOSFETs, which provides excellent R_{DS(on)} and efficiency for most of the small power switching and load switch applications. The CST3407A meet the RoHS and Green Product requirement with full function reliability approved.

CST3407A SOT 23 Pin Configurations

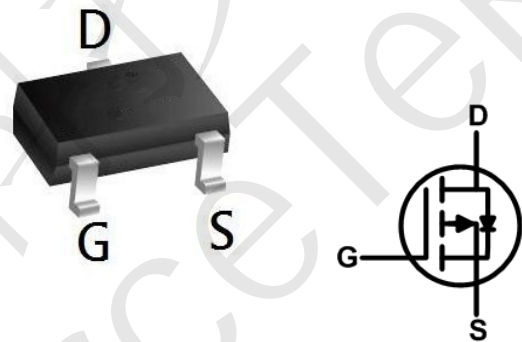

CST3407A Absolute Maximum Ratings

Symbol	Parameter	Rating	Units
V _{DS}	Drain-Source Voltage	-30	V
V _{GS}	Gate-Source Voltage	±20	V
I _D @T _A =25°C	Continuous Drain Current	-4.5	A
I _D @T _A =70°C	Continuous Drain Current	-3.6	A
I _{DM}	Pulsed Drain Current ²	-16	A
P _D @T _A =25°C	Total Power Dissipation ³	1.4	W
P _D @T _A =70°C	Total Power Dissipation ³	0.9	W
T _{STG}	Storage Temperature Range	-55 to 150	°C
T _J	Operating Junction Temperature Range	-55 to 150	°C

CST3407A Thermal Data

Symbol	Parameter	Typ.	Max.	Unit
R _{θJA}	Thermal Resistance Junction-Ambient ¹	---	105	°C/W
R _{θJA}	Thermal Resistance Junction-Ambient ¹ (t ≤ 10s)	---	---	°C/W



CST3407A P-Ch 30V Fast Switching MOSFETs

CST3407A Electrical Characteristics (T_J=25°C unless otherwise noted)

Parameter	Symbol	Conditions	Min.	Typ.	Max.	Unit
Static Characteristics						
Drain-Source Breakdown Voltage	V _{(BR)DSS}	V _{GS} = 0V, I _D = -250μA	-30	-	-	V
Zero Gate Voltage Drain Current	I _{DSS}	V _{DS} = -30V, V _{GS} = 0V	-	-	-1	μA
Gate-Source Leakage	I _{GSS}	V _{DS} = 0V, V _{GS} = ±20V	-	-	±100	nA
Gate-Source Threshold voltage	V _{GS(th)}	V _{DS} = V _{GS} , I _D = -250μA	-1	-1.5	-2.5	V
Drain-Source on-State Resistance ³	R _{DS(on)}	V _{GS} = -10V, I _D = -4.1A	-	42	60	mΩ
		V _{GS} = -4.5V, I _D = -3A	-	54	85	
Dynamic Characteristics⁴						
Input Capacitance	C _{iss}	V _{GS} = 0V, V _{DS} = -15V, f = 1.0MHz	-	530	-	pF
Output Capacitance	C _{oss}		-	70	-	
Reverse Transfer Capacitance	C _{rss}		-	56	-	
Switching Characteristics⁴						
Total Gate Charge	Q _g	V _{GS} = -10V, V _{DS} = -15V, I _D = -4.1A	-	6.8	-	nC
Gate-Source Charge	Q _{gs}		-	1.0	-	
Gate-Drain Charge	Q _{gd}		-	1.4	-	
Turn-on Delay Time	t _{d(on)}	V _{GS} = -10V, V _{DS} = -15V, R _L = 15Ω, R _{GEN} = 2.5Ω	-	14	-	ns
Rise Time	t _r		-	61	-	
Turn-off Delay time	t _{d(off)}		-	19	-	
Fall Time	t _f		-	10	-	
Source-Drain Body Diode Characteristics						
Diode Forward Voltage ³	V _{SD}	I _S = -4.1A, V _{GS} = 0V	-	-	-1.2	V
Continuous Source Current	I _S		-	-	-4.1	A

Notes:

1. Repetitive rating, pulse width limited by junction temperature T_{J(MAX)}=150°C.
2. The data tested by surface mounted on a 1 inch2 FR-4 board with 2OZ copper, The value in any given application depends on the user's specific board design.
3. Pulse Test: Pulse width≤300μs, duty cycle≤2%.
4. This value is guaranteed by design hence it is not included in the production test.



CST3407A Typical Characteristics

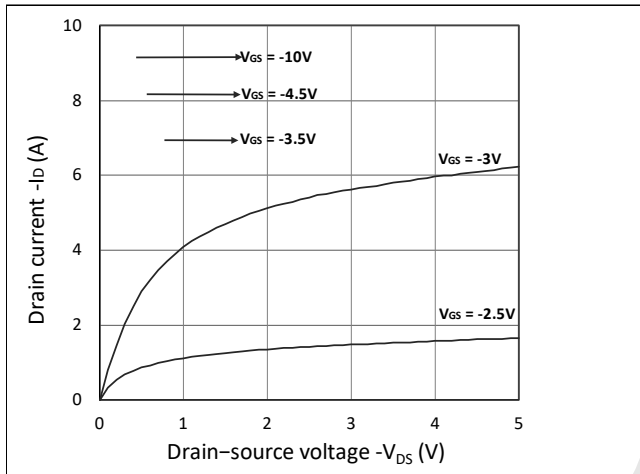

Figure 1. Output Characteristics

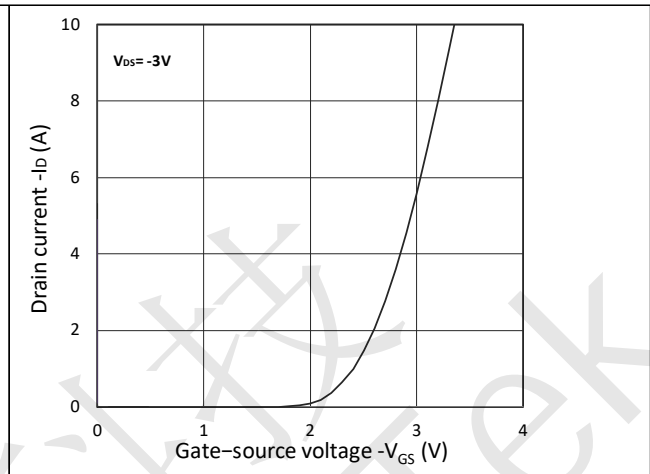

Figure 2. Transfer Characteristics

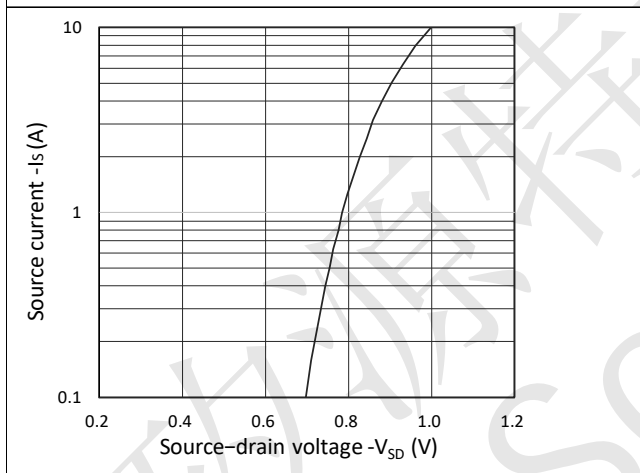

Figure 3. Forward Characteristics of Reverse

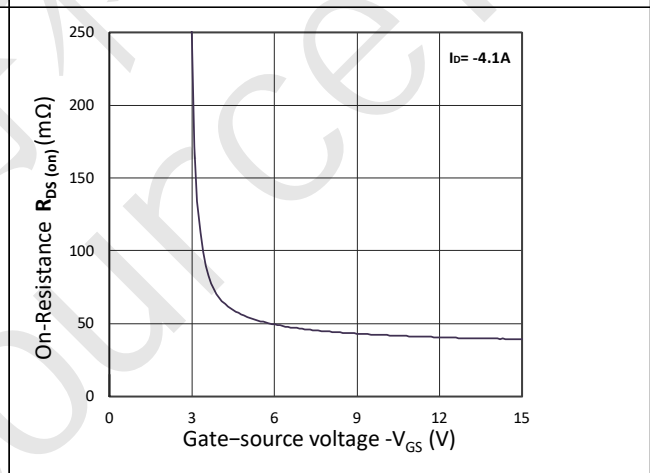

Figure 4. $R_{DS(on)}$ vs. V_{GS}

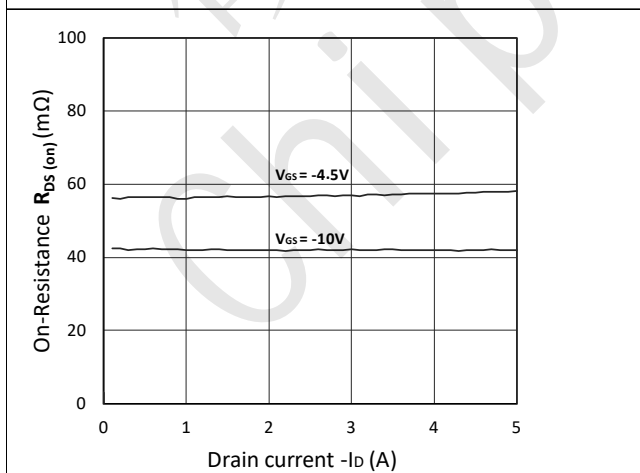

Figure 5. $R_{DS(on)}$ vs. I_D

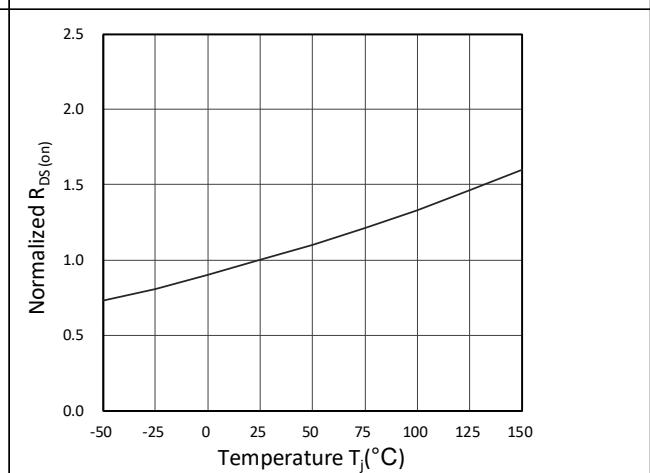

Figure 6. Normalized $R_{DS(on)}$ vs. Temperature

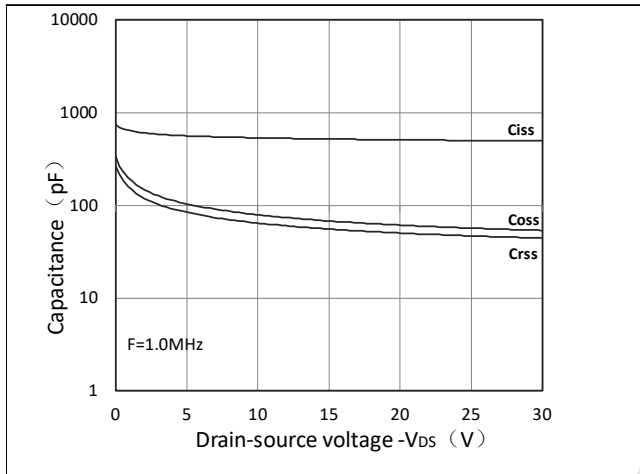

Figure 7. Capacitance Characteristics

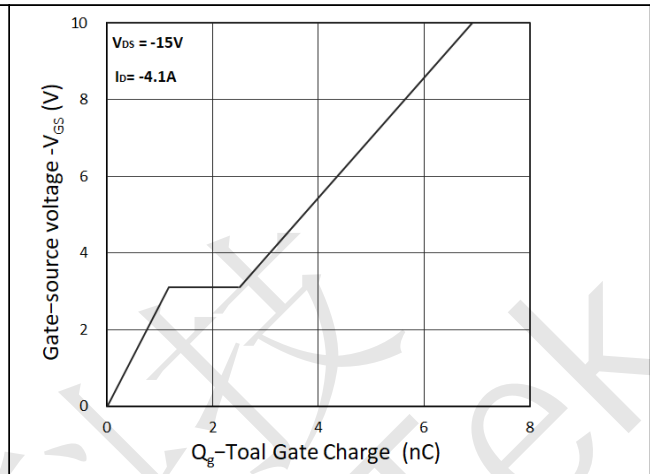
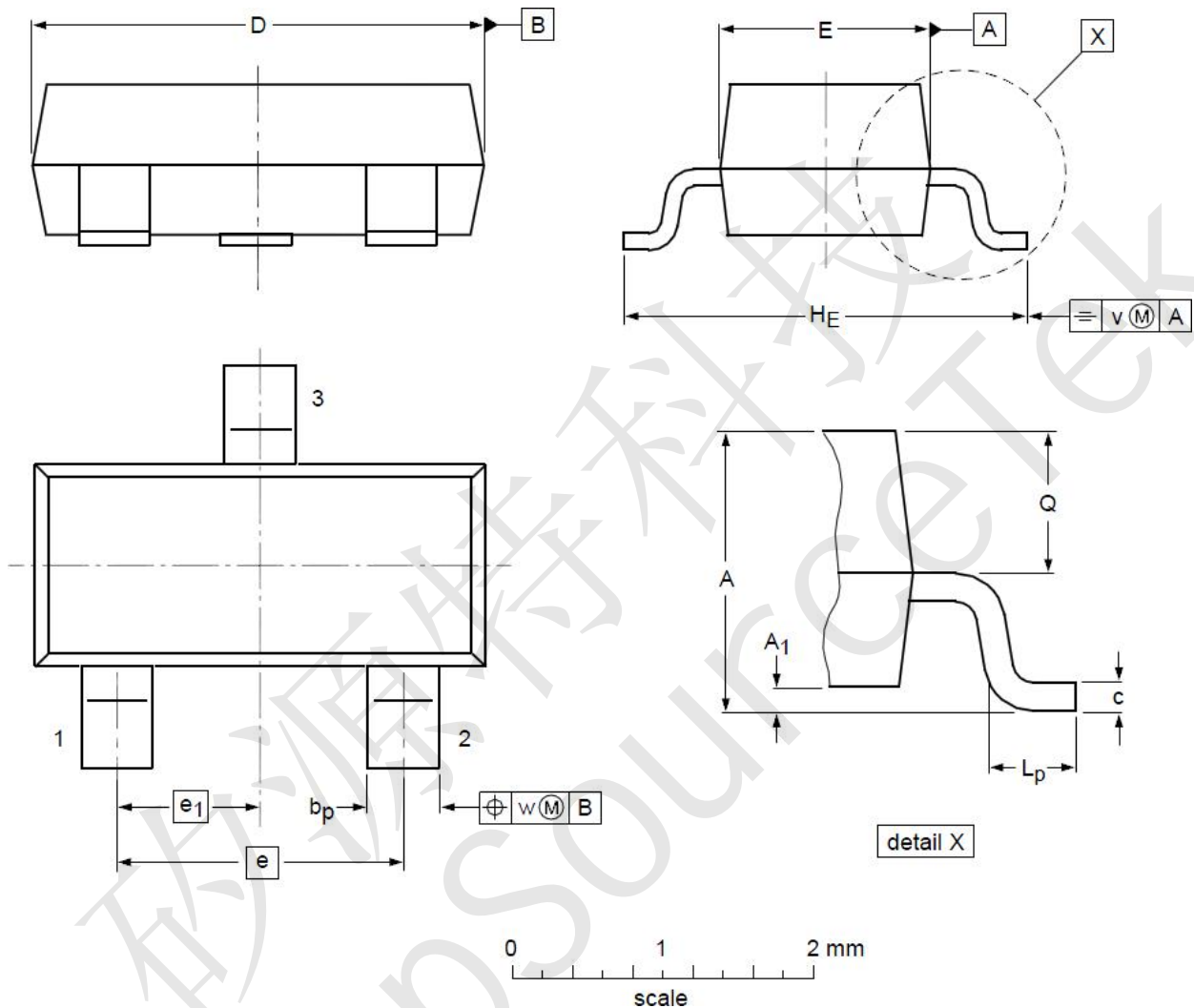

Figure 8. Gate Charge Characteristics



CST3407A Package Mechanical Data-SOT-23



DIMENSIONS (unit : mm)

Symbol	Min	Typ	Max	Symbol	Min	Typ	Max
A	0.90	1.01	1.15	A ₁	0.01	0.05	0.10
b _p	0.30	0.42	0.50	c	0.08	0.13	0.15
D	2.80	2.92	3.00	E	1.20	1.33	1.40
e	--	1.90	--	e ₁	--	0.95	--
H _E	2.25	2.40	2.55	L _p	0.30	0.42	0.50
Q	0.45	0.49	0.55	v	--	0.20	--
w	--	0.10	--				