



CST40N02D N-Ch 20V Fast Switching MOSFETs

- ★ 100% EAS Guaranteed
- ★ Green Device Available
- ★ Super Low Gate Charge
- ★ Excellent CdV/dt effect decline
- ★ Advanced high cell density Trench technology

CST40N02D Product Summary



BVDSS	RDSON	ID
20V	6.3 mΩ	40A

CST40N02D Description

The CST40N02D is the high cell density trenched N-ch MOSFETs, which provide excellent RDSON and gate charge for most of the synchronous buck converter applications.

The CST40N02D meet the RoHS and Green Product requirement, 100% EAS guaranteed with full function reliability approved.

CST40N02D PDFN3333-8L Pin Configuration

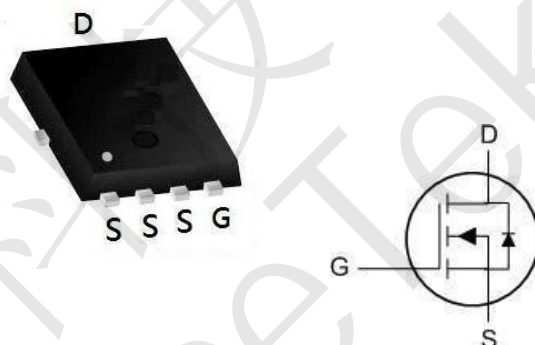

CST40N02D Absolute Maximum Ratings

Symbol	Parameter	Rating	Units
V_{DS}	Drain-Source Voltage	20	V
V_{GS}	Gate-Source Voltage	± 20	V
$I_D@T_C=25^\circ C$	Continuous Drain Current, $V_{GS} @ 10V^1$	40	A
$I_D@T_C=100^\circ C$	Continuous Drain Current, $V_{GS} @ 10V^1$	23	A
I_{DM}	Pulsed Drain Current ²	210	A
EAS	Single Pulse Avalanche Energy ³	36	mJ
I_{AS}	Avalanche Current	21	A
$P_D@T_C=25^\circ C$	Total Power Dissipation ⁴	15	W
T_{STG}	Storage Temperature Range	-55 to 150	$^\circ C$
T_J	Operating Junction Temperature Range	-55 to 150	$^\circ C$
$R_{\theta JC}$	Thermal Resistance Junction-Case ¹	4.8	$^\circ C/W$



CST40N02D N-Ch 20V Fast Switching MOSFETs

CST40N02D Electrical Characteristics (T_J=25°C unless otherwise specified)

Symbol	Parameter	Test Condition	Min.	Typ.	Max.	Units
Off Characteristic						
V _{(BR)DSS}	Drain-Source Breakdown Voltage	V _{GS} =0V, I _D =250μA	20	-	-	V
I _{DSS}	Zero Gate Voltage Drain Current	V _{DS} =20V, V _{GS} =0V,	-	-	1.0	μA
I _{GSS}	Gate to Body Leakage Current	V _{DS} =0V, V _{GS} =±12V	-	-	±100	nA
On Characteristics						
V _{GS(th)}	Gate Threshold Voltage	V _{DS} =V _{GS} , I _D =250μA	0.4	0.7	1.1	V
R _{DS(on)}	Static Drain-Source on-Resistance note3	V _{GS} =4.5V, I _D =25A	-	6.3	8.0	mΩ
		V _{GS} =2.5V, I _D =10A	-	8.8	13	
Dynamic Characteristics						
C _{iss}	Input Capacitance	V _{DS} =10V, V _{GS} =0V, f=1.0MHz	-	1458	-	pF
C _{oss}	Output Capacitance		-	238	-	pF
C _{rss}	Reverse Transfer Capacitance		-	212	-	pF
Q _g	Total Gate Charge	V _{DS} =10V, I _D =25A, V _{GS} =4.5V	-	19	-	nC
Q _{gs}	Gate-Source Charge		-	3	-	nC
Q _{gd}	Gate-Drain("Miller") Charge		-	6.4	-	nC
Switching Characteristics						
t _{d(on)}	Turn-on Delay Time	V _{DS} =10V, I _D =10A, R _{GEN} =3Ω, V _{GS} =4.5V	-	10	-	ns
t _r	Turn-on Rise Time		-	21	-	ns
t _{d(off)}	Turn-off Delay Time		-	39	-	ns
t _f	Turn-off Fall Time		-	19	-	ns
Drain-Source Diode Characteristics and Maximum Ratings						
I _S	Maximum Continuous Drain to Source Diode Forward Current		-	-	40	A
I _{SM}	Maximum Pulsed Drain to Source Diode Forward Current		-	-	200	A
V _{SD}	Drain to Source Diode Forward Voltage	V _{GS} =0V, I _S =30A	-	-	1.2	V
t _{rr}	Body Diode Reverse Recovery Time	IF=20A, dI/dt=100A/μs	-	25	-	ns
Q _{rr}	Body Diode Reverse Recovery Charge		-	20	-	nC

Notes: 1. Repetitive Rating: Pulse Width Limited by Maximum Junction Temperature

2. EAS condition: T_J=25°C, V_{DD}=10V, V_G=4.5V, L=0.5mH, R_G=25Ω, I_{AS}=12A

3. Pulse Test: Pulse Width≤300μs, Duty Cycle≤0.5%



CST40N02D Typical Characteristics

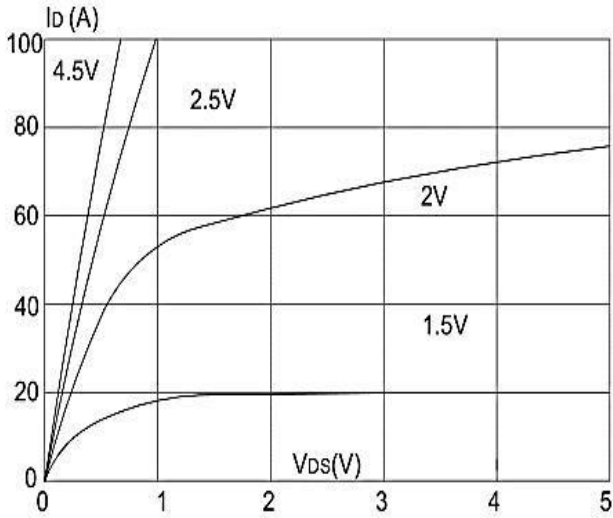

Figure 1: Output Characteristics

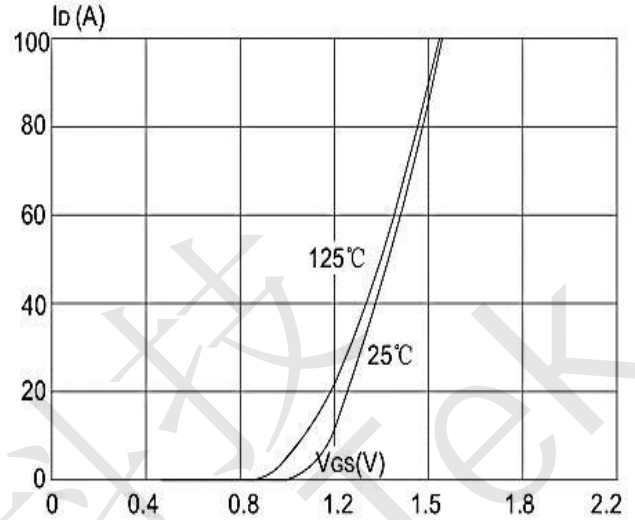

Figure 2: Typical Transfer Characteristics

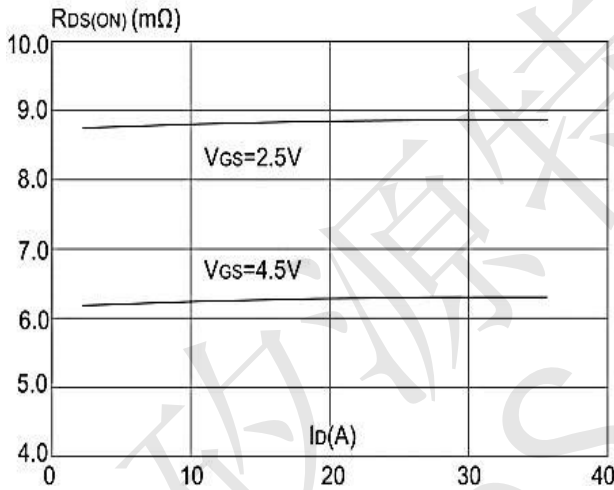

Figure 3: On-resistance vs. Drain Current

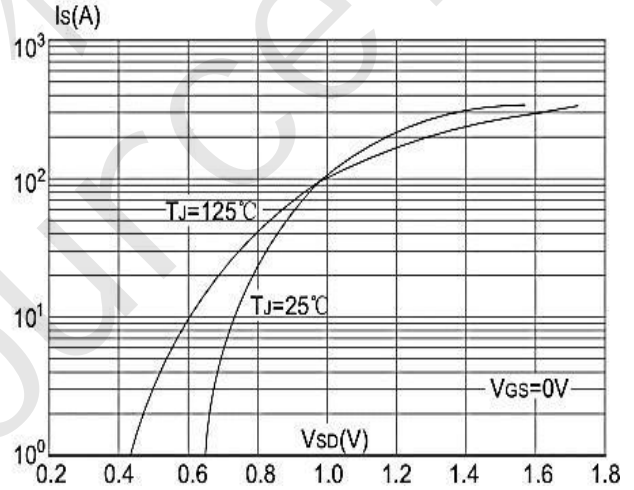

Figure 4: Body Diode Characteristics

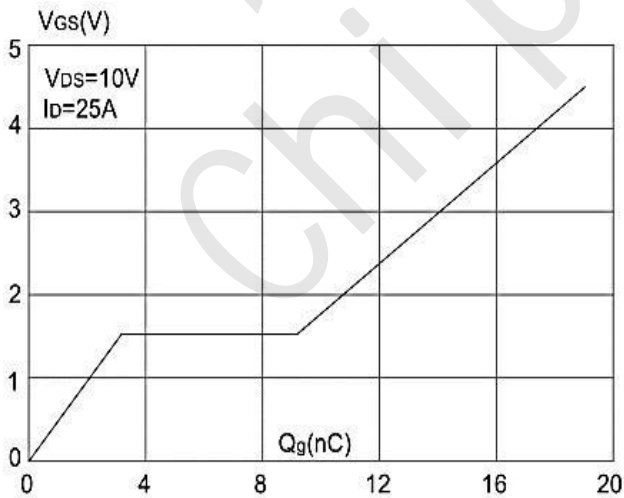

Figure 5: Gate Charge Characteristics

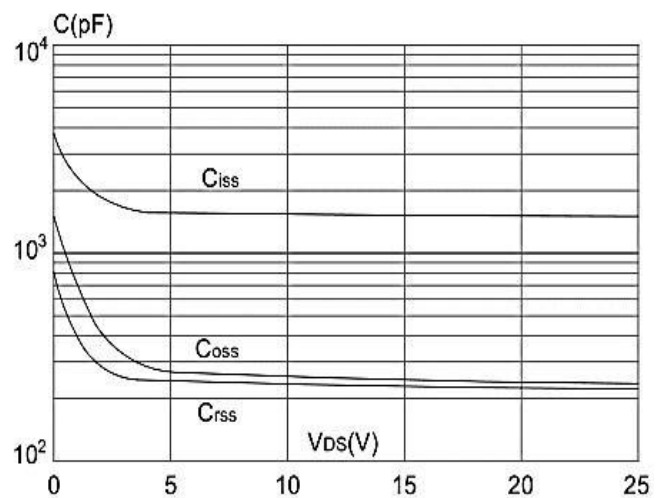

Figure 6: Capacitance Characteristics



CST40N02D N-Ch 20V Fast Switching MOSFETs

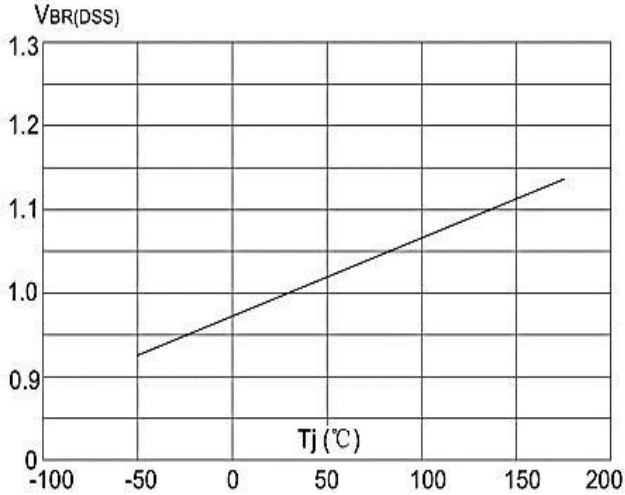

Figure 7: Normalized Breakdown Voltage vs. Junction Temperature

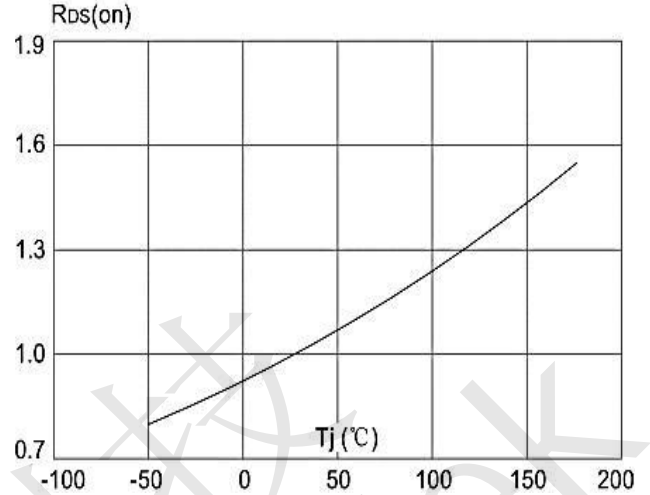

Figure 8: Normalized on Resistance vs. Junction Temperature

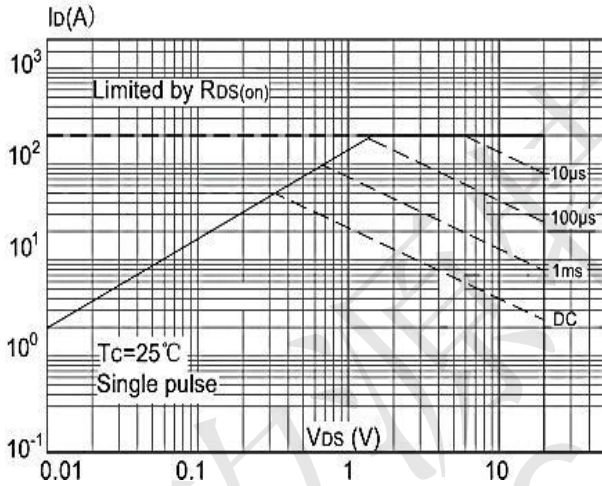

Figure 9: Maximum Safe Operating Area vs. Case Temperature

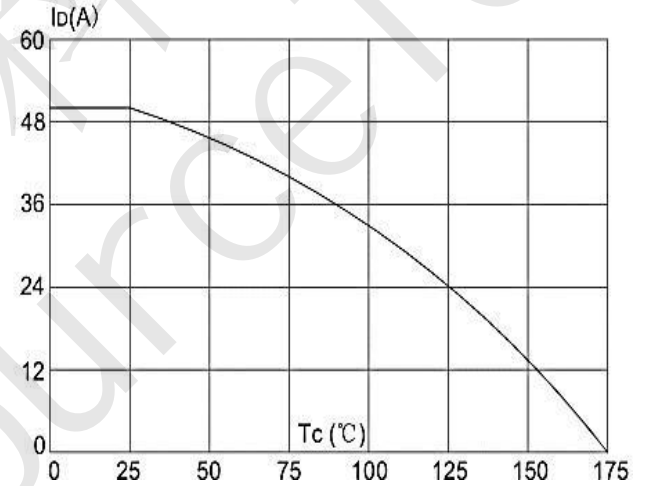

Figure 10: Maximum Continuous Drain Current vs. Case Temperature

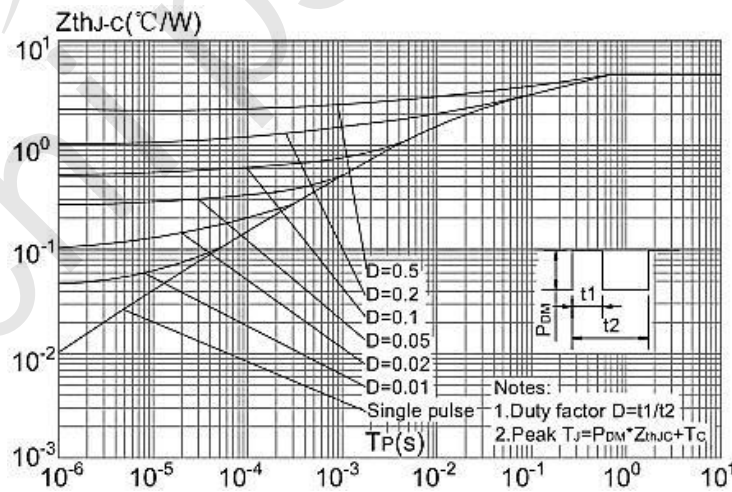
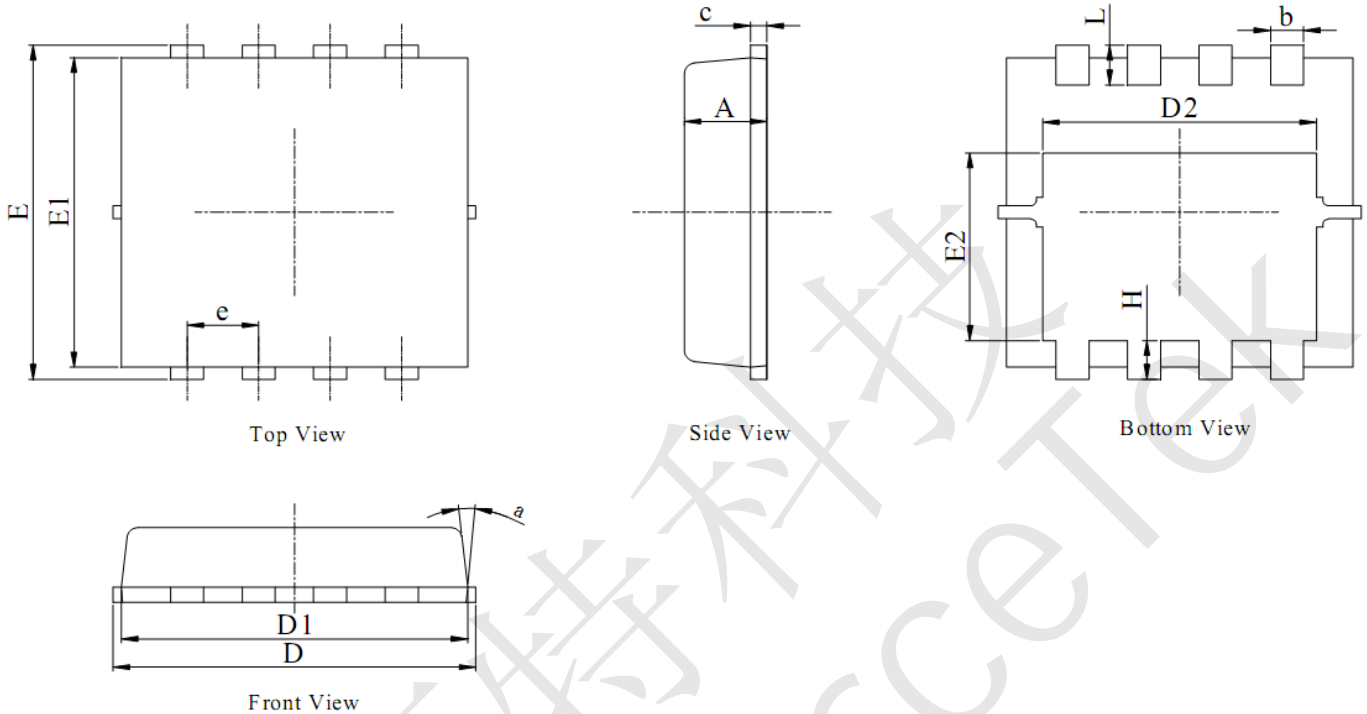

Figure.11: Maximum Effective Transient Thermal Impedance, Junction-to-Case



CST40N02D Package Mechanical Data-PDFN3333-8L-Single



NOTES:

1. DIMENSIONING AND TOLERANCING PER ASME Y14.5M,1994.
2. ALL DIMENSIONS IN MILLIMETER (ANNGLE IN DEGREE).
3. DIMENSIONS D1 AND E1 DO NOT INCLUDE MOLD FLASH PROTRUSIONS OR GATE BURRS.

DIM.	MILLIMETER		
	MIN.	NOM.	MAX.
A	0.70	0.75	0.80
b	0.25	0.30	0.35
c	0.10	0.20	0.25
D	3.00	3.15	3.25
D1	2.95	3.05	3.15
D2	2.39	2.49	2.59
E	3.20	3.30	3.40
E1	2.95	3.05	3.15
E2	1.70	1.80	1.90
e	0.65 BSC		
H	0.30	0.40	0.50
L	0.25	0.40	0.50
a	---	---	15°

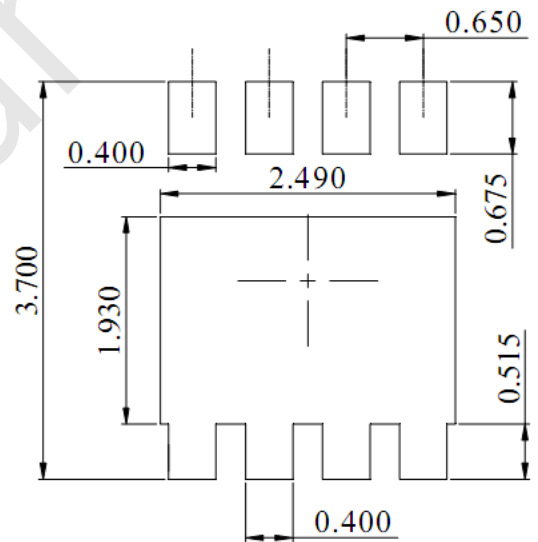

DIMENSIONS: MILLIMETERS