



CST4803A Dual P-Ch 30V Fast Switching MOSFETs



- ★ Green Device Available
- ★ Super Low Gate Charge
- ★ Excellent CdV/dt effect decline
- ★ Advanced high cell density Trench technology

CST4803A Product Summary

BVDSS	RDSON	ID
-30V	35mΩ	-5.3A

CST4803A Description

The CST4803A is the high cell density trenched P-ch MOSFETs, which provide excellent RDSON and gate charge for most of the synchronous buck converter applications.

The CST4803A meet the RoHS and Green

Product requirement 100% EAS guaranteed with full function reliability approved.

CST4803A SOP8 Pin Configuration

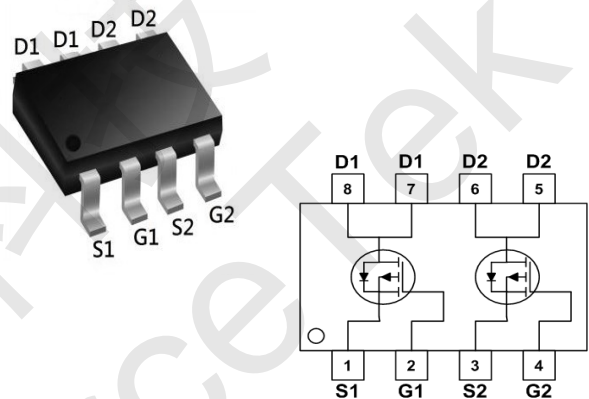

CST4803A Absolute Maximum Ratings

Symbol	Parameter	Rating	Units
V_{DS}	Drain-Source Voltage	-30	V
V_{GS}	Gate-Source Voltage	± 20	V
$I_{D@T_A=25^\circ C}$	Continuous Drain Current, $V_{GS} @ 10V^1$	-5.3	A
$I_{D@T_A=70^\circ C}$	Continuous Drain Current, $V_{GS} @ 10V^1$	-4.3	A
I_{DM}	Pulsed Drain Current ²	-20	A
EAS	Single Pulse Avalanche Energy ³	---	mJ
I_{AS}	Avalanche Current	---	A
$P_D@T_A=25^\circ C$	Total Power Dissipation ⁴	2.0	W
T_{STG}	Storage Temperature Range	-55 to 150	$^\circ C$
T_J	Operating Junction Temperature Range	-55 to 150	$^\circ C$

CST4803A Thermal Data

Symbol	Parameter	Typ.	Max.	Unit
$R_{\theta JA}$	Thermal Resistance Junction-Ambient ¹	---	100	$^\circ C/W$
$R_{\theta JC}$	Thermal Resistance Junction-Case ¹	---	---	$^\circ C/W$



CST4803A Dual P-Ch 30V Fast Switching MOSFETs

CST4803A Electrical Characteristics (T_J=25°C unless otherwise noted)

Parameter	Symbol	Test Conditions	Min.	Typ.	Max.	Unit
Static Characteristics						
Drain-Source Breakdown Voltage	BV_{DSS}	V _{GS} = 0V, I _D = -250μA	-30	-	-	V
Gate-body Leakage current	I_{GSS}	V _{DS} = 0V, V _{GS} = ±20V	-	-	±100	nA
Zero Gate Voltage Drain Current	I_{DSS}	V _{DS} = -30V, V _{GS} = 0V	-	-	-1	μA
Gate-Threshold Voltage	V_{GS(th)}	V _{DS} = V _{GS} , I _D = -250μA	-1.0	-1.5	-2.1	V
Drain-Source On-Resistance ³	R_{DS(on)}	V _{GS} = -10V, I _D = -4.1A	-	35	55	mΩ
		V _{GS} = -4.5V, I _D = -3A	-	52	85	
Dynamic Characteristics⁴						
Input Capacitance	C_{iss}	V _{DS} = -15V, V _{GS} = 0V, f = 1MHz	-	530	-	pF
Output Capacitance	C_{oss}		-	70	-	
Reverse Transfer Capacitance	C_{rss}		-	56	-	
Switching Characteristics⁴						
Total Gate Charge	Q_g	V _{GS} = -10V, I _D = -4.1A, V _{DS} = -15V	-	10	-	nC
Gate-Source Charge	Q_{gs}		-	2	-	
Gate-Drain Charge	Q_{gd}		-	2.8	-	
Turn-On Delay Time	t_{d(on)}	V _{GS} = -10V, V _{DD} = -15V, , R _{GEN} = 6Ω, I _D = -4.1A,	-	6.9	-	ns
Rise Time	t_r		-	12	-	
Turn-Off Delay Time	t_{d(off)}		-	19	-	
Fall Time	t_f		-	7.5	-	
Source-Drain Body Diode Characteristics						
Diode Forward Voltage ³	V_{SD}	I _S = -1.7A, V _{GS} = 0V	-	-	-1.2	V
Continuous Source Current	I_S		-	-	-5.3	A

Notes:

1. Repetitive rating, pulse width limited by junction temperature T_{J(MAX)}=150°C.
2. The data tested by surface mounted on a 1 inch2 FR-4 board with 20Z copper, The value in any given application depends on the user's specific board design.
3. Pulse Test: Pulse width≤300μs, duty cycle≤2%.
4. This value is guaranteed by design hence it is not included in the production test.



CST4803A Typical Characteristics

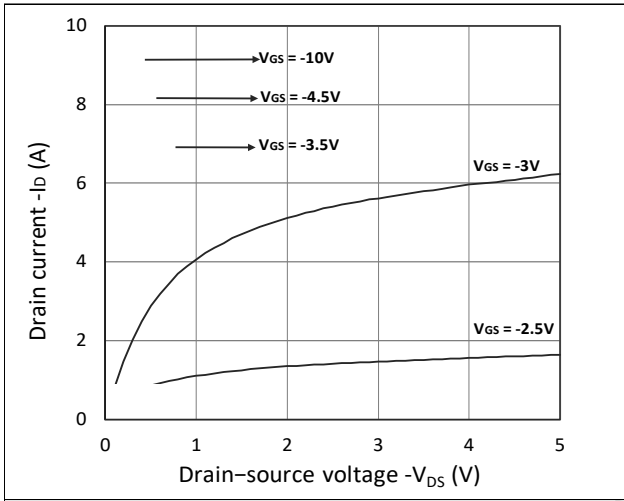

Figure 1. Output Characteristics

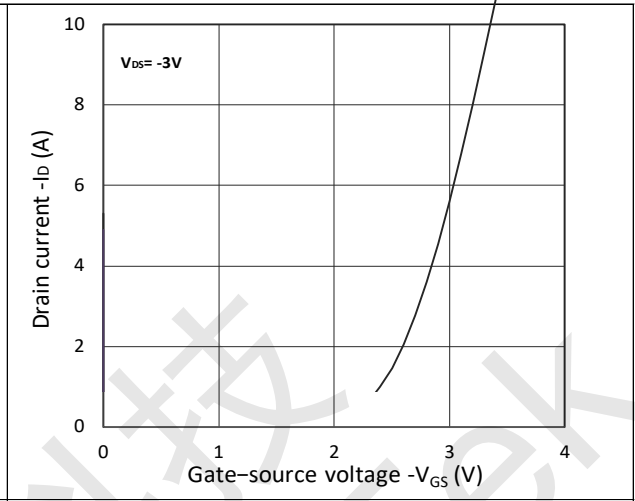

Figure 2. Transfer Characteristics

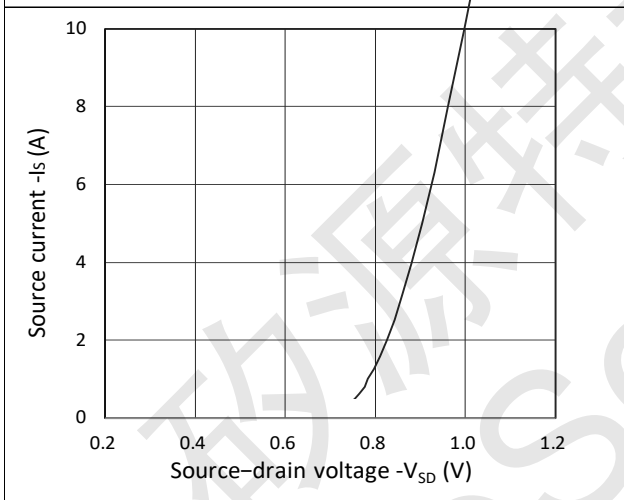

Figure 3. Forward Characteristics of Reverse

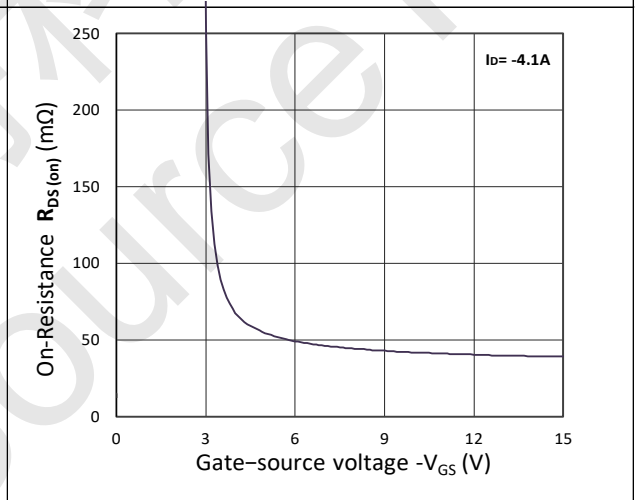

Figure 4. $R_{DS(on)}$ vs. V_{GS}

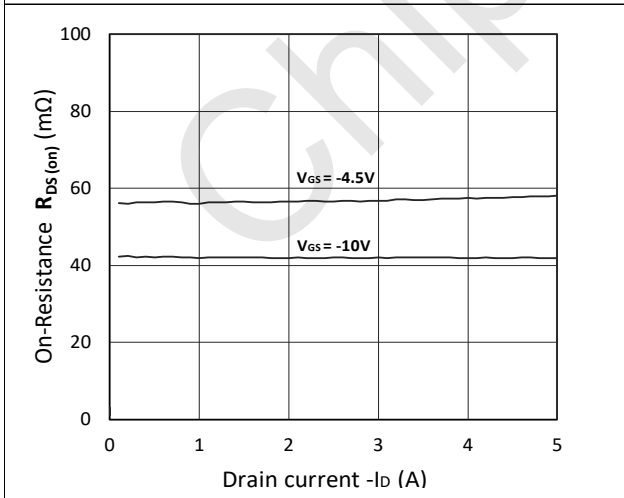

Figure 5. $R_{DS(on)}$ vs. I_D

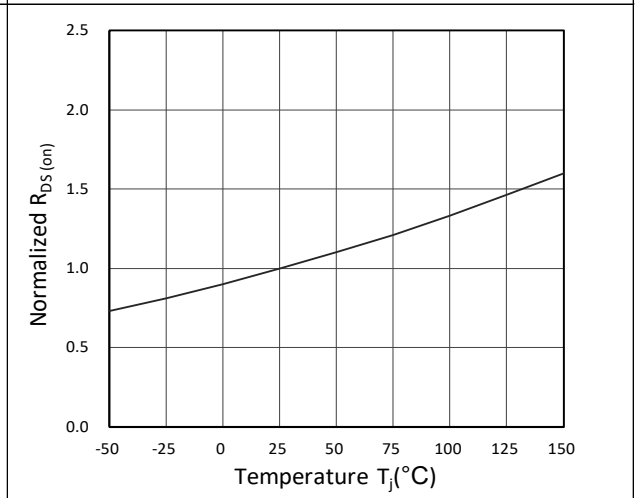

Figure 6. Normalized $R_{DS(on)}$ vs. Temperature

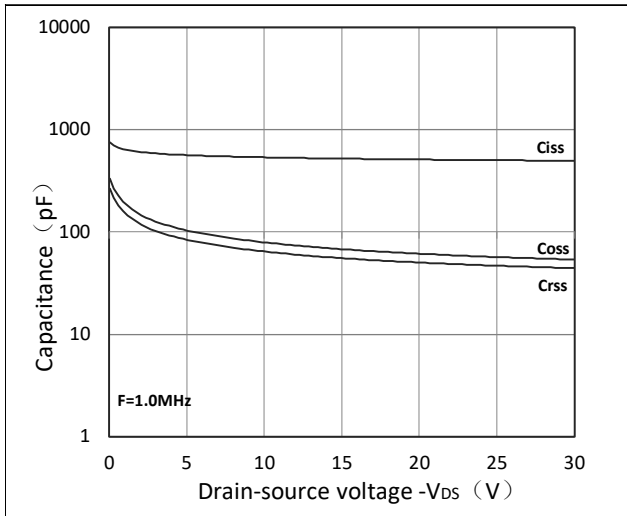

Figure 7. Capacitance Characteristics

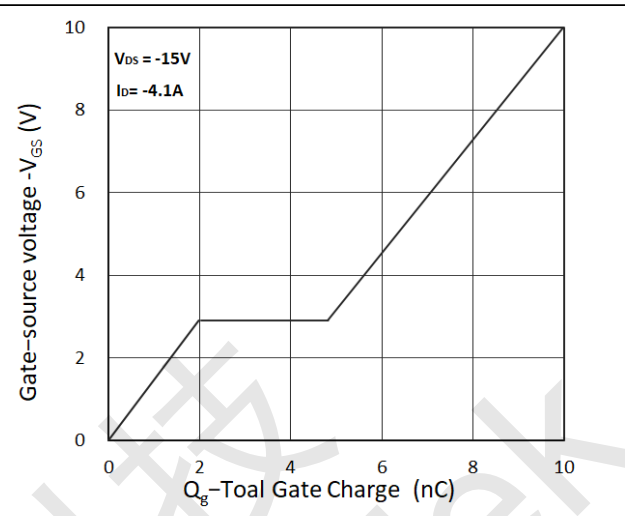

Figure 8. Gate Charge Characteristics



CST4803A Package Mechanical Data- SOP-8

Symbol	Dimensions In Millimeters		Dimensions In Inches	
	Min.	Max.	Min.	Max.
A	1.350	1.750	0.053	0.069
A1	0.100	0.250	0.004	0.010
A2	1.350	1.550	0.053	0.061
b	0.330	0.510	0.013	0.020
c	0.170	0.250	0.006	0.010
D	4.700	5.100	0.185	0.200
E	3.800	4.000	0.150	0.157
E1	5.800	6.200	0.228	0.244
e	1.270(BSC)		0.050(BSC)	
L	0.400	1.270	0.016	0.050
θ	0°	8°	0°	8°