



## CSTS40N10 N-Ch 100V Fast Switching MOSFETs

### CSTS40N10 Features

- Split Gate Trench MOSFET technology
- Excellent package for heat dissipation
- High density cell design for low  $R_{DS(ON)}$

### CSTS40N10 Product Summary



BVDSS	RDSON	ID
100V	20 mΩ	40A

### CSTS40N10 Applications

- DC-DC Converters
- Power management functions
- Synchronous-rectification applications

### CSTS40N10 TO252 Pin Configuration

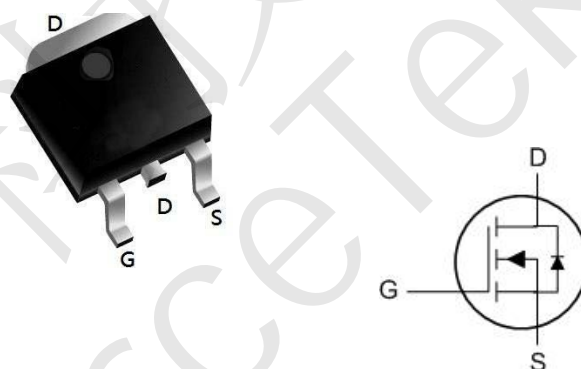

### CSTS40N10 Absolute Maximum Ratings $T_C=25^\circ\text{C}$ unless otherwise specified

Symbol	Parameter	Max.	Units
$V_{DSS}$	Drain-Source Voltage	100	V
$V_{GSS}$	Gate-Source Voltage	$\pm 20$	V
$I_D$	Continuous Drain Current <sup>note5</sup>	40	A
$I_D$	Continuous Drain Current <sup>note5</sup>	16	A
$I_{DM}$	Pulsed Drain Current <sup>note3</sup>	100	A
$P_D$	Power Dissipation <sup>note2</sup>	27	W
$I_{AS}$	Avalanche Current <sup>note3,6</sup>	8	A
$E_{AS}$	Single Pulse Avalanche Energy <sup>note3,6</sup>	16	mJ
$R_{\theta JC}$	Thermal Resistance, Junction to Case	4.65	$^\circ\text{C}/\text{W}$
$R_{\theta JA}$	Thermal Resistance, Junction to Ambient <sup>note1,4</sup>	62	$^\circ\text{C}/\text{W}$
$T_J, T_{STG}$	Operating and Storage Temperature Range	-55 to +150	$^\circ\text{C}$



CSTS40N10 N-Ch 100V Fast Switching MOSFETs

**CSTS40N10 Electrical Characteristics**  $T_C=25^\circ\text{C}$  unless otherwise specified

Symbol	Parameter	Test Condition	Min.	Typ.	Max.	Units
<b>Off Characteristic</b>						
$BV_{DSS}$	Drain-Source Breakdown Voltage	$V_{GS} = 0V, I_D = 250\mu A$	100	-	-	V
$I_{DSS}$	Drain-Source Leakage Current	$V_{DS} = 80V, V_{GS} = 0V$	-	-	1	$\mu A$
$I_{GSS}$	Gate to Body Leakage Current	$V_{DS} = 0V, V_{GS} = \pm 20V$	-	-	$\pm 100$	nA
<b>On Characteristics</b>						
$V_{GS(th)}$	Gate Threshold Voltage	$V_{DS} = V_{GS}, I_D = 250\mu A$	1.2	1.8	2.6	V
$R_{DS(on)}$	Static Drain-Source On-Resistance	$V_{GS} = 10V, I_D = 15A$	-	20	23	m $\Omega$
		$V_{GS} = 4.5V, I_D = 10A$	-	-	33	m $\Omega$
$g_{fs}$	Forward Threshold Voltage	$V_{DS} = 10V, I_D = 20A$	-	22	-	S
$R_g$	Gate Resistance	$V_{DS} = V_{GS} = 0V, f = 1.0MHz$	-	1.62	-	$\Omega$
<b>Dynamic Characteristics</b>						
$C_{iss}$	Input Capacitance	$V_{DS} = 50V, V_{GS} = 0V,$ $f = 1.0MHz$	-	822	-	pF
$C_{oss}$	Output Capacitance		-	310	-	pF
$C_{rss}$	Reverse Transfer Capacitance		-	23.5	-	pF
<b>Switching Characteristics</b>						
$Q_g$	Total Gate Charge	$V_{DS} = 50V, I_D = 20A,$ $V_{GS} = 10V$	-	22.7	-	nC
$Q_{gs}$	Gate-Source Charge		-	6.2	-	
$Q_{gd}$	Gate-Drain("Miller") Charge		-	5.3	-	
$t_{d(on)}$	Turn-On Delay Time	$V_{DS} = 50V, I_D = 20A,$ $R_G = 3\Omega, V_{GS} = 10V$	-	15	-	ns
$t_r$	Turn-On Rise Time		-	3.2	-	
$t_{d(off)}$	Turn-Off Delay Time		-	30	-	
$t_f$	Turn-Off Fall Time		-	7.6	-	
<b>Diode Characteristics</b>						
$I_S$	Continuous Source Current		-	-	40	A
$V_{SD}$	Diode Forward Voltage	$I_S = 20A, V_{GS} = 0V$	-	0.88	1.0	V
$t_{rr}$	Reverse Recovery Time	$I_{SD} = 20A,$	-	45	-	ns
$Q_{rr}$	Reverse Recovery Charge	$dI_{SD}/dt = 100A/\mu s$	-	59	-	nC

Notes:

1. The value of  $R_{\theta JC}$  is measured in a still air environment with  $T_A = 25^\circ\text{C}$  and the maximum allowed junction temperature of  $150^\circ\text{C}$ . The value in any given application depends on the user's specific board design.
2. The power dissipation  $P_D$  is based on  $T_{J(MAX)} = 150^\circ\text{C}$ , using junction-to-case thermal resistance, and is more useful in setting the upper dissipation limit for cases where additional heatsinking is used.
3. Single pulse width limited by junction temperature  $T_{J(MAX)} = 150^\circ\text{C}$ .
4. The  $R_{\theta JA}$  is the sum of the thermal impedance from junction to case  $R_{\theta JC}$  and case to ambient.
5. The maximum current rating is package limited.
6. The EAS data shows Max. rating. The test condition is  $V_{DS} = 50V, V_{GS} = 10V, L = 0.5mH$



## CSTS40N10 Typical Performance Characteristics

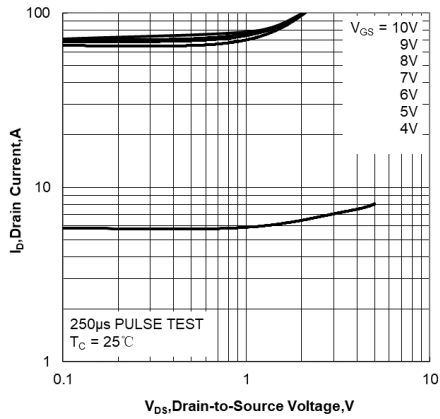

Figure 1. Output Characteristics

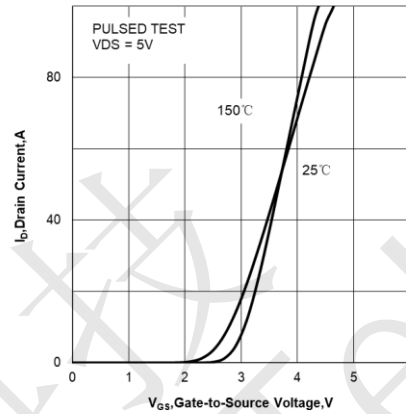

Figure 2. Transfer Characteristics

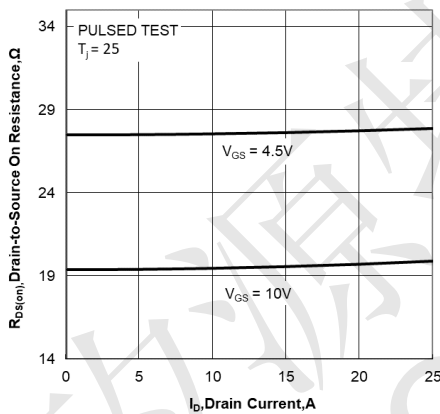

Figure 3. Drain-to-Source On Resistance vs Drain Current

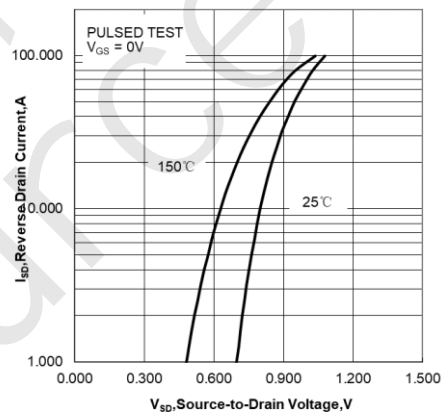

Figure 4. Body Diode Forward Voltage vs Source Current and Temperature

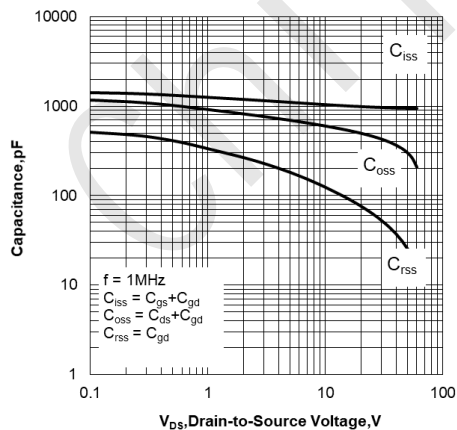

Figure 5. Capacitance Characteristics

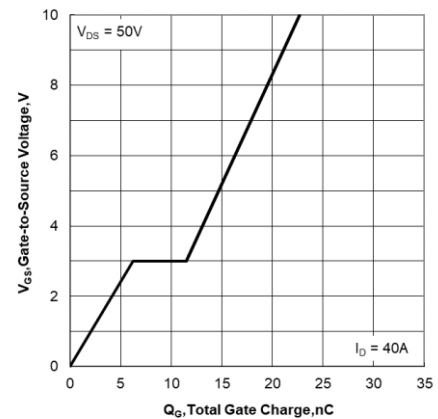

Figure 6. Gate Charge Characteristics



CSTS40N10 N-Ch 100V Fast Switching MOSFETs

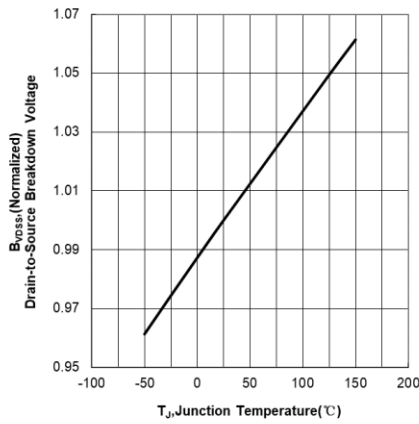

Figure 7. Normalized Breakdown Voltage vs Junction Temperature

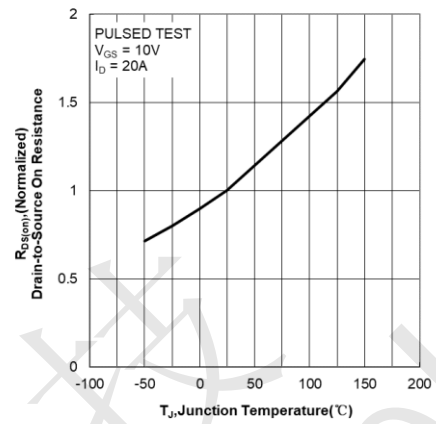

Figure 8. Normalized On Resistance vs Junction Temperature

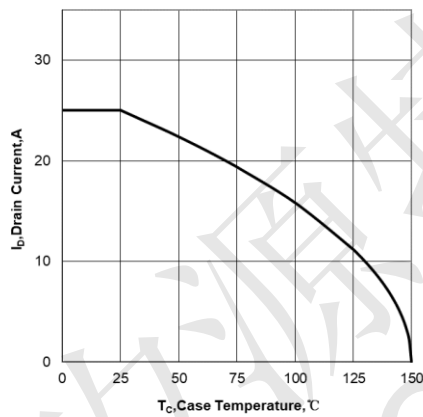

Figure 9. Maximum Continuous Drain Current vs Case Temperature

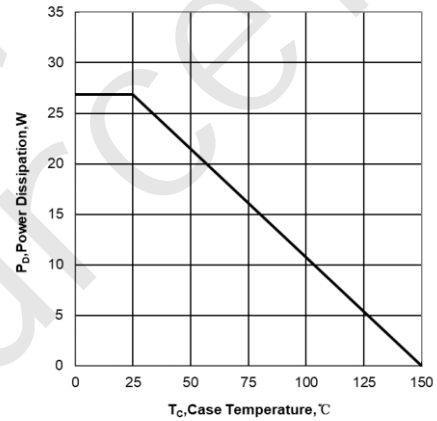

Figure 10. Maximum Power Dissipation vs Case Temperature

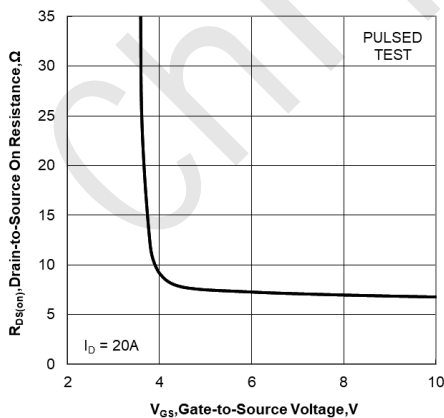

Figure 11. Drain-to-Source On Resistance vs Gate

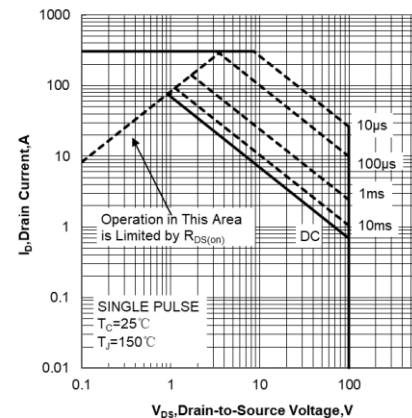

Figure 12. Maximum Safe Operating Area



CSTS40N10 N-Ch 100V Fast Switching MOSFETs

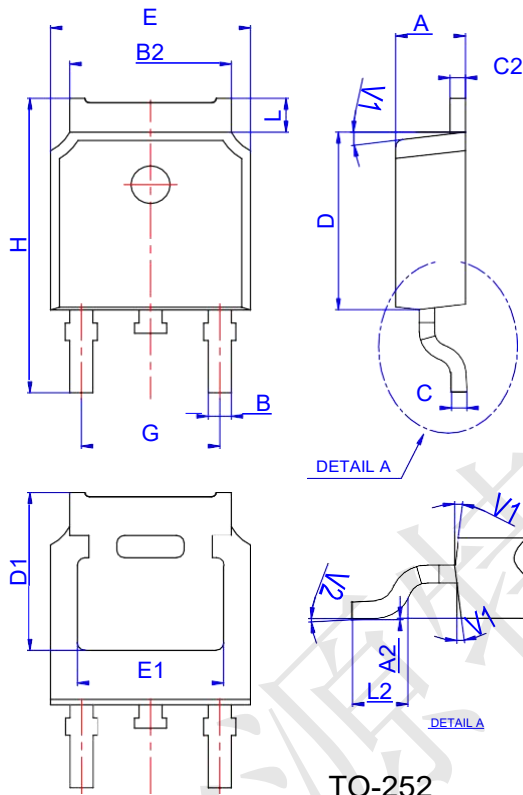

Figure 13. Maximum Effective Transient Thermal Impedance, Junction-to-Case



CSTS40N10 N-Ch 100V Fast Switching MOSFETs

CSTS40N10 Package Mechanical Data TO-252



Ref.	Dimensions					
	Millimeters			Inches		
	Min.	Typ.	Max.	Min.	Typ.	Max.
A	2.10		2.50	0.083		0.098
A2	0		0.10	0		0.004
B	0.66		0.86	0.026		0.034
B2	5.18		5.48	0.202		0.216
C	0.40		0.60	0.016		0.024
C2	0.44		0.58	0.017		0.023
D	5.90		6.30	0.232		0.248
D1	5.30REF			0.209REF		
E	6.40		6.80	0.252		0.268
E1	4.63			0.182		
G	4.47		4.67	0.176		0.184
H	9.50		10.70	0.374		0.421
L	1.09		1.21	0.043		0.048
L2	1.35		1.65	0.053		0.065
V1		7°			7°	
V2		0°	6°	0°		6°

CSTS40N10 Reel Specification-TO-252-4R

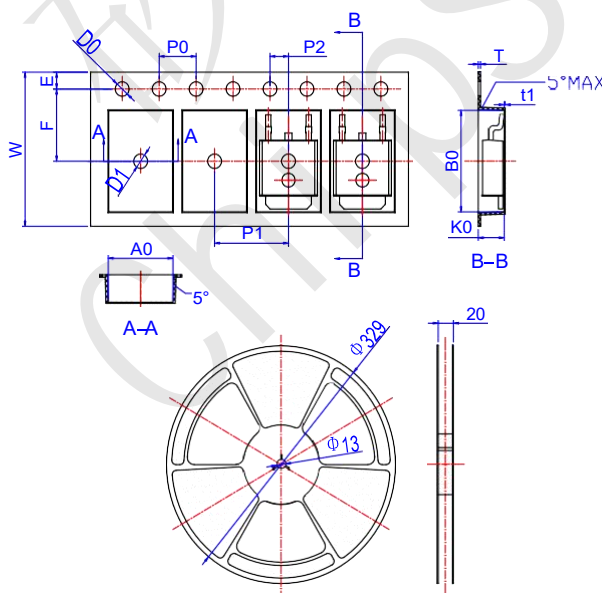

Ref.	Dimensions					
	Millimeters			Inches		
	Min.	Typ.	Max.	Min.	Typ.	Max.
W	15.90	16.00	16.10	0.626	0.630	0.634
E	1.65	1.75	1.85	0.065	0.069	0.073
F	7.40	7.50	7.60	0.291	0.295	0.299
D0	1.40	1.50	1.60	0.055	0.059	0.063
D1	1.40	1.50	1.60	0.055	0.059	0.063
P0	3.90	4.00	4.10	0.154	0.157	0.161
P1	7.90	8.00	8.10	0.311	0.315	0.319
P2	1.90	2.00	2.10	0.075	0.079	0.083
A0	6.85	6.90	7.00	0.270	0.271	0.276
B0	10.45	10.50	10.60	0.411	0.413	0.417
K0	2.68	2.78	2.88	0.105	0.109	0.113
T	0.24		0.27	0.009		0.011
t1	0.10			0.004		
10P0	39.80	40.00	40.20	1.567	1.575	1.583