



FM5N50 N-Channel Power Mosfet

FM5N50 Features <ul style="list-style-type: none"> ● 500V,5A Ros <ON) <1.5 Q@VGs=10V TYP:1.25 Q ● Fast Switching ● Lead free product is acquired ● Excellent Ros <ON) and Low Gate Charge 	FM5N50 Application <ul style="list-style-type: none"> ● PWM applications ● Load Switch ● Power management
FM5N50 Package <div style="display: flex; justify-content: space-around; align-items: flex-end;"> <div data-bbox="284 600 464 869"> <p>Marking and pin assignment</p> </div> <div data-bbox="651 622 970 831"> <p>TO-252top view</p> </div> <div data-bbox="1082 600 1305 869"> <p>Schematic diagram</p> </div> </div>	

FM5N50 Package Marking and Ordering Information

Device Marking	Device	Device Package	Reel Size	Tape width	Quantity (PCS)
FM5N50	FM5N50	TO-252	13 inch	-	2500

FM5N50 Absolute Maximum Ratings (T_C=25°C unless otherwise specified)

Parameter	Symbol	Value	Unit
Drain-Source Voltage	V _{os}	500	V
Gate-Source Voltage	V _{Gs}	±30	V
Continuous Drain Current (T _a =25°C)	I _o	5	A
Continuous Drain Current (T _a =100°C)	I _o	3	A
Pulsed Drain Current (1I)	I _{oM}	20	A
Single Pulsed Avalanche Energy <2>	E _{As}	88	mJ
Power Dissipation	P _o	54	w
Thermal Resistance from Junction to Case	ReJc	2.13	°C/W
Junction Temperature	T _J	150	°C/
Storage Temperature	T _{srG}	-55~+150	°C/



FM5N50 N-Channel Power Mosfet

FM5N50 Electrical Characteristics (T_J=25°C unless otherwise noted)

Parameter	Symbol	Test Condition	Min	Type	Max	Unit
Static Characteristics						
Drain-source breakdown voltage	V _{(BR)DSS}	V _{GS} =0V, I _D =250μA	500	-	-	V
Zero gate voltage drain current	I _{DSS}	V _{DS} =500V, V _{GS} =0V	-	-	1	μA
Gate-body leakage current	I _{GSS}	V _{GS} =±30V, V _{DS} =0V	-	-	±100	nA
Gate threshold voltage ⁽³⁾	V _{GS(th)}	V _{DS} =V _{GS} , I _D =250μA	2	3.3	4	V
Drain-source on-resistance ⁽³⁾	R _{DS(on)}	V _{GS} =10V, I _D =2.5A	-	1.25	1.5	Ω
Forward tranconductance ⁽³⁾	g _{FS}	V _{DS} =10V, I _D =0.25A	1	-	-	S
Dynamic characteristics						
Input Capacitance	C _{ISS}	V _{DS} =25V, V _{GS} =0V, f=1MHz	-	650	-	pF
Output Capacitance	C _{OSS}		-	57	-	
Reverse Transfer Capacitance	C _{rss}		-	13	-	
Switching characteristics						
Turn-off delay time	t _{d(off)}	V _{DD} =250V, I _D =5A, V _{GS} =10V, R _G =25Ω	-	20	-	ns
Total Gate Charge	Q _g	V _{DS} =400V, I _D =5A, V _{GS} =10V	-	26	-	nC
Gate-Source Charge	Q _{gs}		-	4	-	
Gate-Drain Charge	Q _{gd}		-	15	-	
Source-Drain Diode characteristics						
Diode Forward voltage ⁽³⁾	V _{DS}	V _{GS} =0V, I _S =5A	-	-	1.4	V
Diode Forward current ⁽⁴⁾	I _S		-	-	5	A
Body Diode Reverse Recovery Time	t _{rr}	T _J =25 °, IF=5A, di/dt=100A/us		220		ns
Body Diode Reverse Recovery Charge	Q _{rr}	T _J =25 °, IF=5A, di/dt=100A/us		1.0		uc

Notes:

1. Repetitive Rating: pulse width limited by maximum junction temperature
2. EAS Condition: T_J=25°C, V_{oo}=50V, R_G=2.0 Ω, L=10mH
3. Pulse Test: pulse width::300μs, duty cycle::2%
4. Surface Mounted on FR4 Board, t::10 sec



FM5N50 N-Channel Power Mosfet

FM5N50 Typical Performance Characteristics

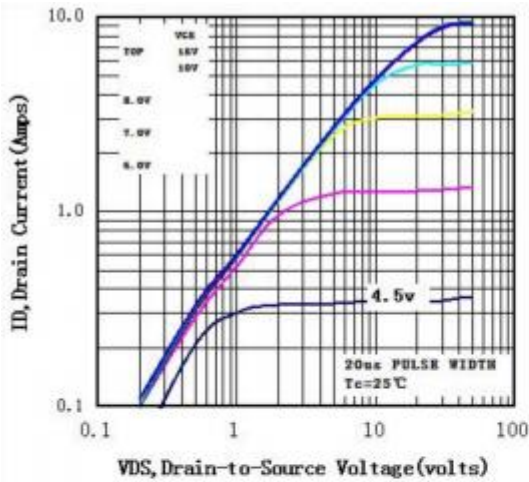

Fig1 Typical Output Characteristics, Tc=25°C

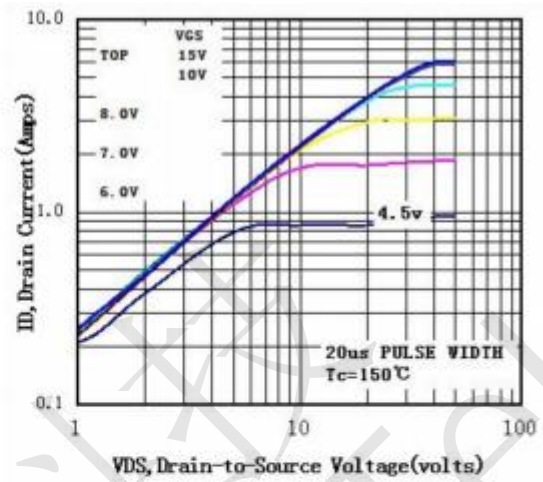

Fig2 Typical Output Characteristics, Tc=150°C

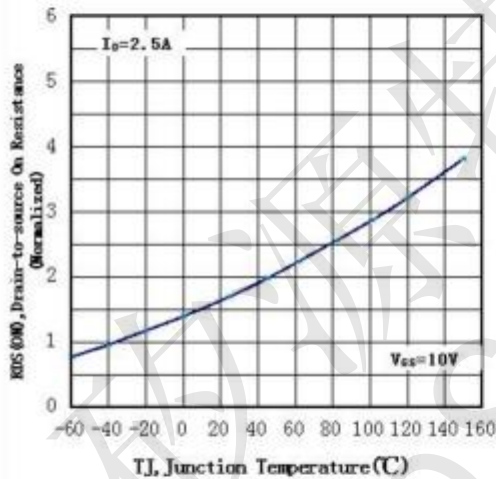

Fig3 Normalized Resistance Vs. Temperature

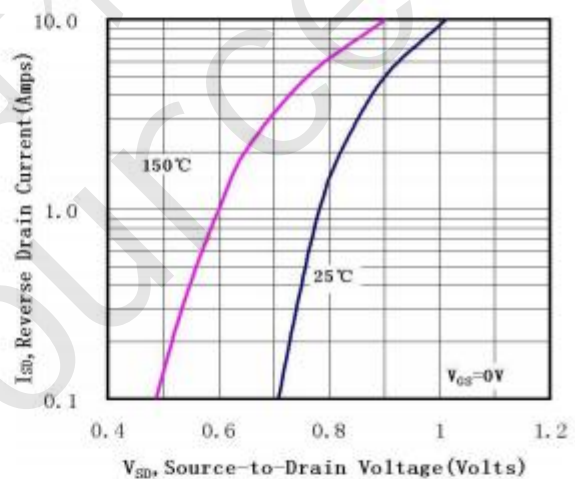

Fig4 Typical Source-Drain Diode Forward Voltage

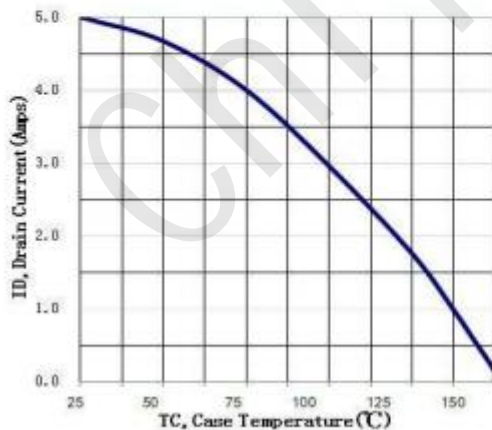

Fig5 Maximum Drain Current Vs. Case Temperature

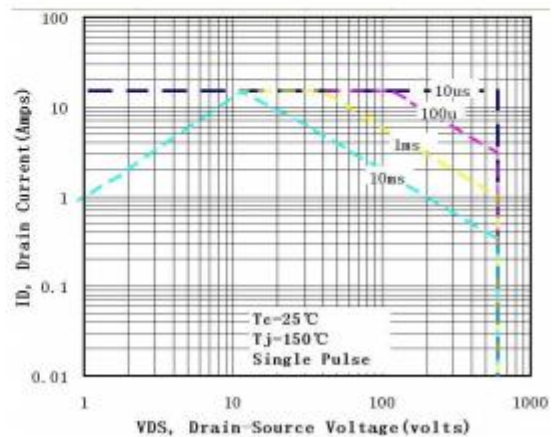
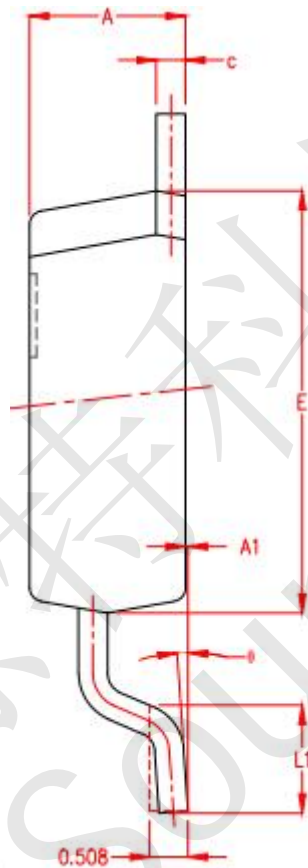
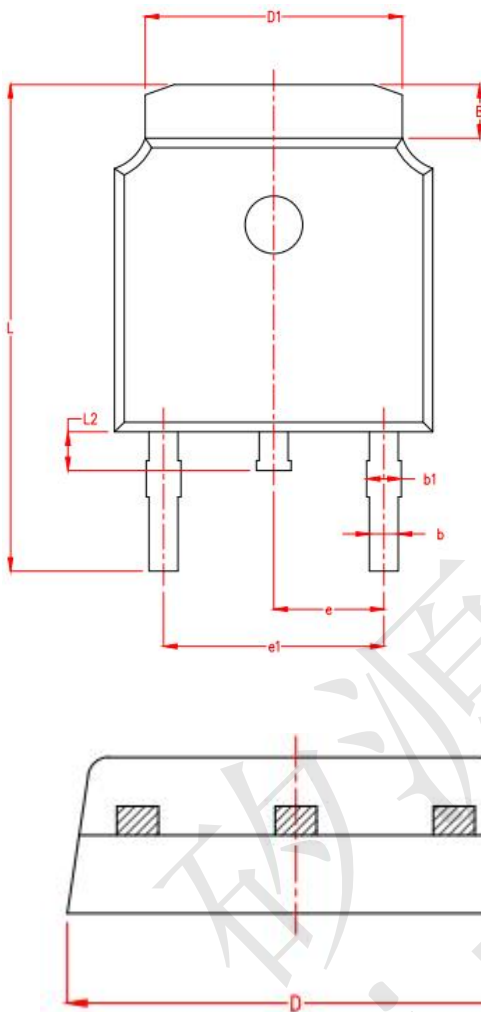

Fig6 Maximum Safe Operating Area



FM5N50 N-Channel Power Mosfet

FM5N50 TO-252 Package Information



SYMBOL	MILLIMETER		
	MIN	NOM	MAX
A	2.15	2.25	2.35
A1	0.00	0.06	0.12
B	0.96	1.11	1.26
b	0.59	0.69	0.79
b1	0.69	0.81	0.93
c	0.34	0.42	0.50
D	6.45	6.60	6.75
D1	5.23	5.33	5.43
E	5.95	6.10	6.25
e	2.286TYP.		
e1	4.47	4.57	4.67
L	9.90	10.10	10.30
L1	1.40	1.55	1.70
L2	0.60	0.80	1.00
θ	0°	4°	8°