



## 3-Terminal Positive Voltage Regulator ME78L05

### General Description

ME78L05 is three-terminal positive regulators. One of these regulators can deliver up to 100 mA of output current. The internal limiting and thermal-shutdown features of the regulator make them essentially immune to overload. When used as a replacement for a zener diode-resistor combination, an effective improvement in output impedance can be obtained, together with lower quiescent current.

### Selection Guide

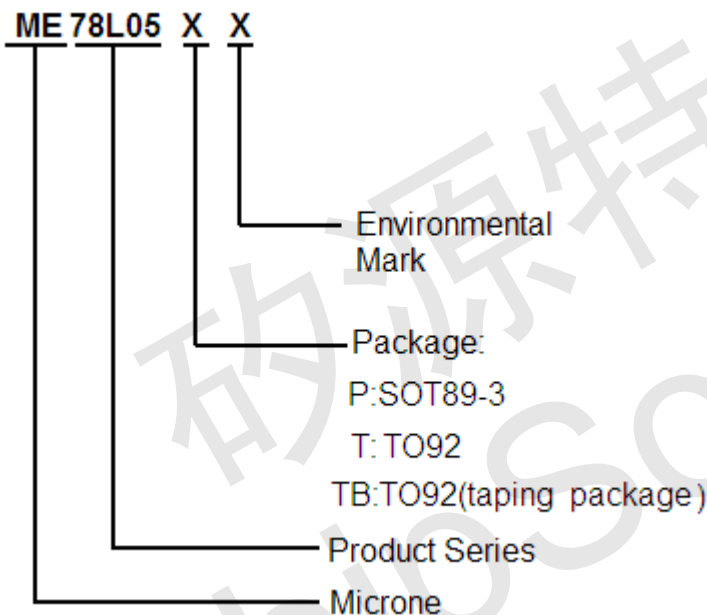

### Features

- Output Current of 100mA
- Output Voltages of  $5V \pm 5\%$  over the temperature range
- Thermal Overload Protection
- Short Circuit Protection
- Output transistor safe area protection
- No external components
- Package: SOT89-3 and TO92(Taping Package)

### Pin Configuration

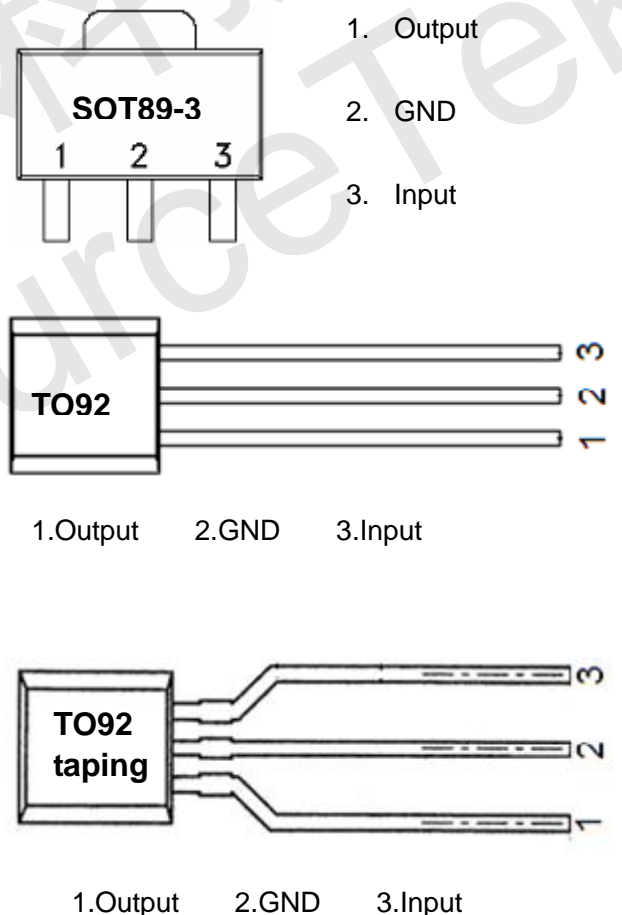



**Maximum Ratings(Ta=25°C)**

Parameter	Rating	Unit
Input supply voltage : VIN	30	V
MAX. Output current:Iout	100	mA
Max Power:Pmax	0.35	W
Maximum junction temperature: T <sub>j</sub>	-25~125	°C
Storage temperature :T <sub>str</sub>	-55~150	°C
Soldering temperature and time	+260 (Recommended 10S)	°C

Caution: The absolute maximum ratings are rated values exceeding which the product could suffer physical damage.

These values must therefore not be exceeded under any conditions.

**Block Diagram**

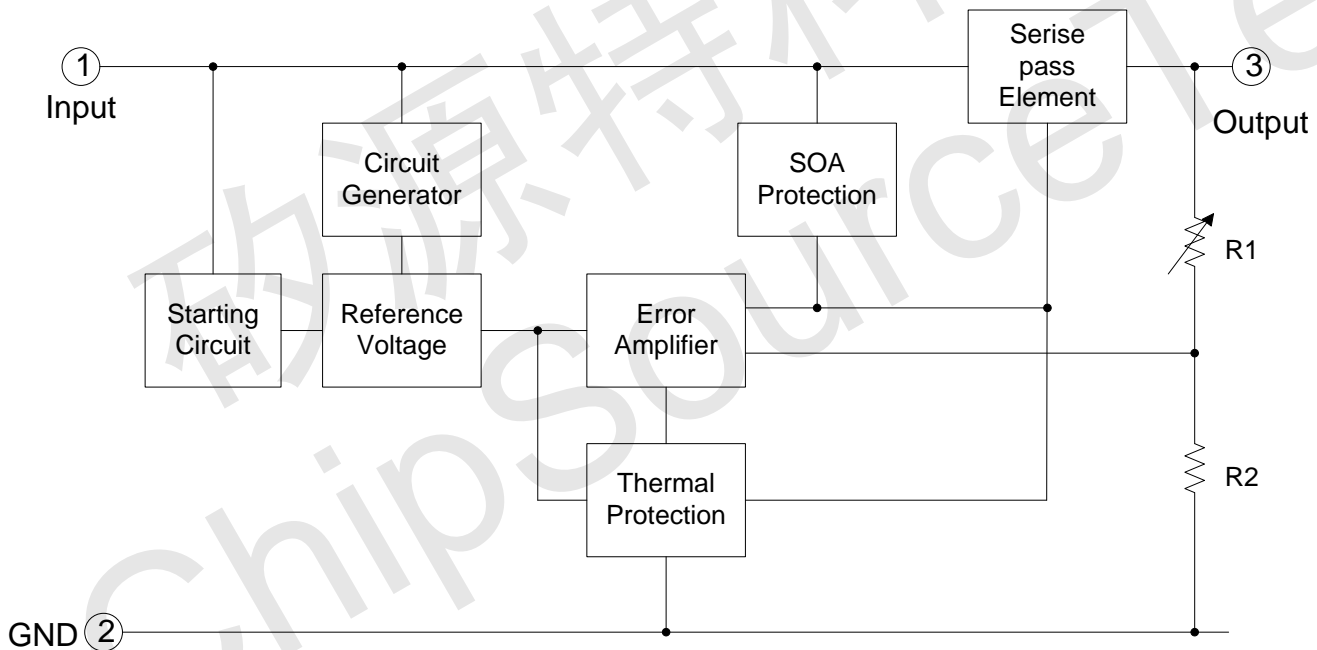



## Electrical Characteristics

(C<sub>in</sub> =0.33μF, C<sub>o</sub> =0.1μF, 0≤T<sub>j</sub>≤125°C, unless otherwise noted)

Parameter	Symbol	Conditions	Min.	Typ.	Max.	Unit
Output Voltage	V <sub>O</sub>	I <sub>O</sub> =40mA, V <sub>IN</sub> =10V	4.82	5.0	5.18	V
		I <sub>O</sub> =1mA~40mA V <sub>IN</sub> =7V~20V	4.8	5.0	5.2	
		I <sub>O</sub> =1mA~10mA V <sub>IN</sub> =10V	4.75	5.0	5.25	
Line Regulations	LNR	V <sub>IN</sub> =7V~20V, I <sub>O</sub> =40mA	-150	-	150	mV
		V <sub>IN</sub> =8V~20V, I <sub>O</sub> =40mA	-100	-	100	
Load Regulation	LDR	V <sub>IN</sub> =10V, I <sub>O</sub> =1mA-100mA	-60	-	60	mV
		V <sub>IN</sub> =10V, I <sub>O</sub> =1mA-40mA	-30	-	30	
Dropout Voltage	V <sub>DIF</sub>	T <sub>j</sub> =25°C, I <sub>O</sub> =100mA	-	2	-	V
Output noise Voltage	V <sub>N</sub>	f=10Hz to 100KHz	-	40	-	μV/V <sub>O</sub>
Ripple Rejection	PSRR	T <sub>j</sub> =25°C, f=120Hz, I <sub>O</sub> =40mA V <sub>IN</sub> =8V~20V	-	80	-	dB
Peak Output Current	I <sub>pk</sub>	T <sub>j</sub> =25°C	-	500	-	mA
Quiescent Current	I <sub>Q</sub>	V <sub>IN</sub> =10V, I <sub>OUT</sub> =40mA	-	-	5.5	mA
Quiescent Current Change	ΔI <sub>Q</sub>	V <sub>IN</sub> =8V~20V, I <sub>O</sub> =40mA	-1.5	-	1.5	mA
		V <sub>IN</sub> =10V, I <sub>O</sub> =1mA~40mA,	-0.1	-	0.1	

LNR: Line Regulation. The change in output voltage for a change in the input voltage. The measurement is made under conditions of low dissipation or by using pulse techniques such that the average chip temperature is not significantly affected.

LDR: Load Regulation. The change in output voltage for a change in load current at constant chip temperature.

## Type Characteristics

Output Voltage vs. Input voltage

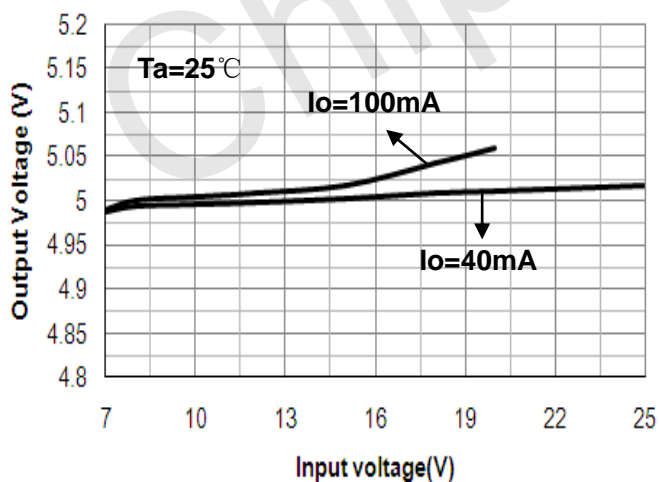

Output Voltage vs. Load

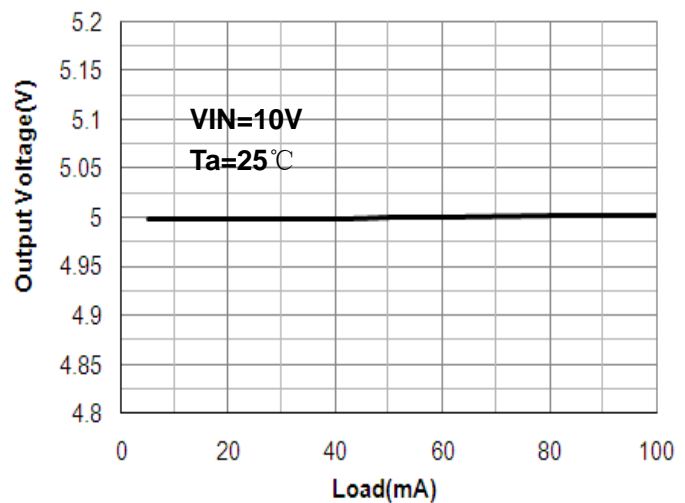



Output Voltage vs. Temperature

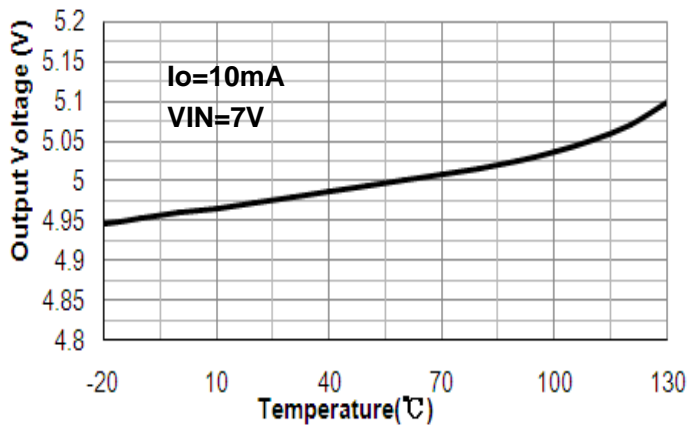

Dropout Voltage vs. Load

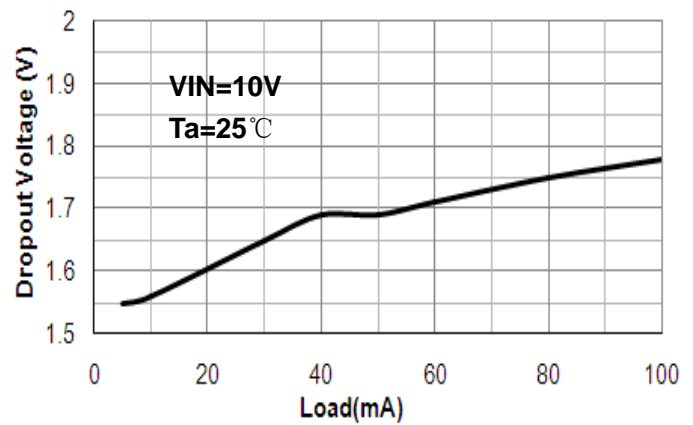

Quiescent Current vs. Input Voltage

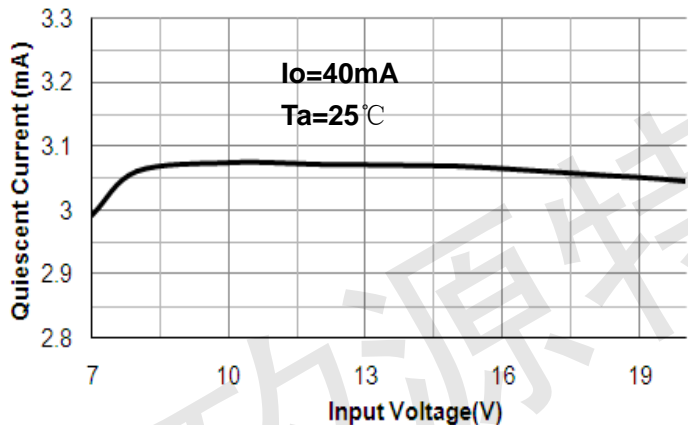

Quiescent Current vs. Load

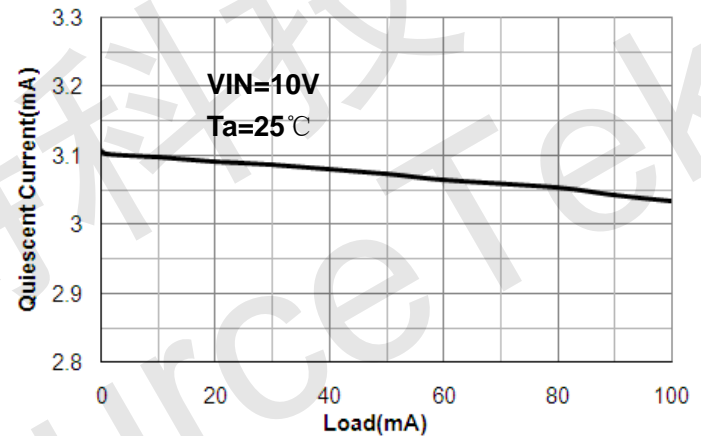

## Operation Description

ME78L05 is designed with Thermal Overload Protection that shuts down the circuit when subjected to an excessive power overload condition, Internal Short Circuit Protection that limits the maximum current the circuit will pass, and Output Transistor Safe-Area Compensation that reduces the output short circuit current as the voltage across the pass transistor is increased.

In many low current applications, compensation capacitors are not required. However, it is recommended that the regulator input be bypassed with a capacitor if the regulator is connected to the power supply filter with long wire lengths, or if the output load capacitance is large. An input bypass capacitor should be selected to provide good high frequency characteristics to insure stable operation under all load conditions. A 0.33μF or larger tantalum, mylar, or other capacitor having low internal impedance at high frequencies should be chosen. The bypass capacitor should be mounted with the shortest possible leads directly across the regulator's input terminals. Normally good construction techniques should be used to minimize ground loops and lead resistance drops since the regulator has no external sense lead.



Typical Application Circuit

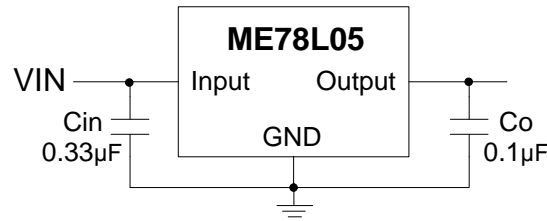

Fig.1 Fixed Output Regulator

A common ground is required between the input and the output voltages. The input voltage must remain typically 2.0 V above the output voltage even during the low point on the input ripple voltage.

- Cin is required if regulator is located an appreciable distance from power supply filter.
- Co is not needed for stability; however, it does improve transient response.

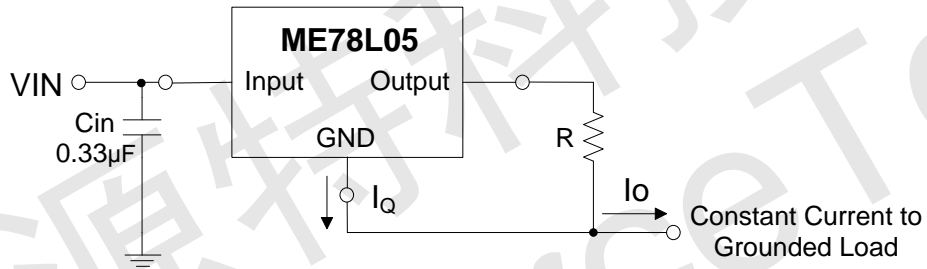

Fig.2 Constant Current Regulator

The ME78L05 regulator can also be used as a current source when connected as Fig.2. In order to minimize dissipation the ME78L05 is chosen in this application. Resistor R determines the current as follows:  $I_o = \frac{5V}{R} + I_q$

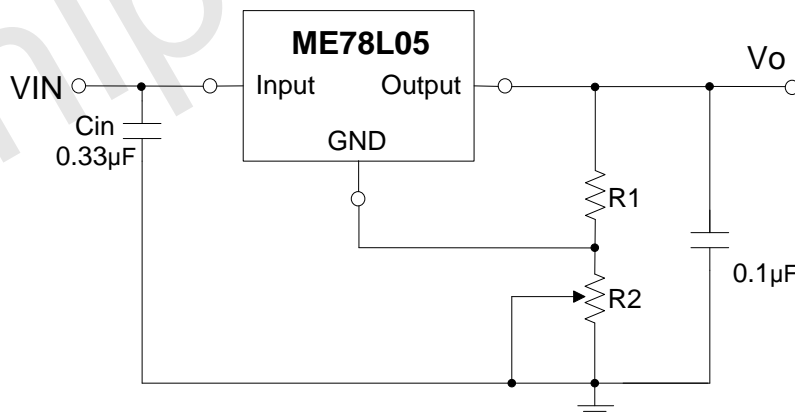

Fig.3 Adjustable Output Regulator

$$V_o = 5V + 5V/R_1 + I_q * R_2$$

$$5V/R_1 > 3 * I_q$$



Package Information

Package Type:SOT89-3 Unit:mm(inch)

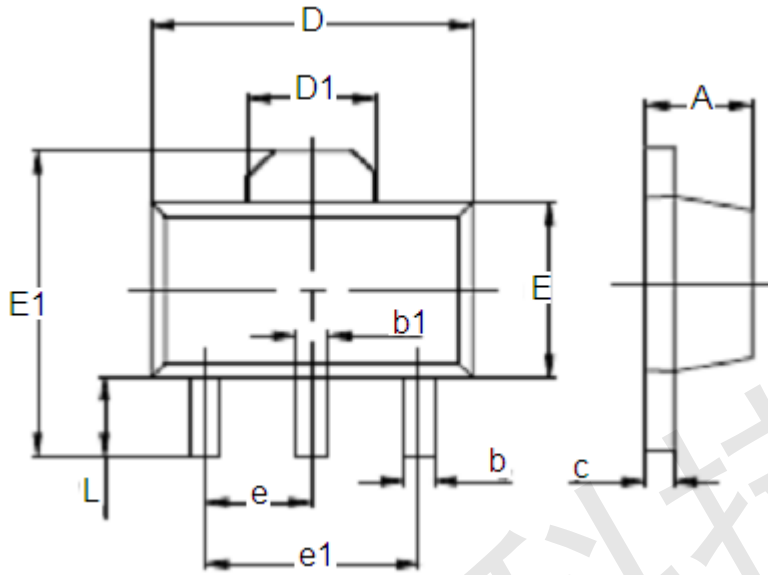

DIM	Millimeters		Inches	
	Min	Max	Min	Max
A	1.4	1.6	0.055	0.063
D	4.4	4.5	0.173	0.181
D1	1.55REF		0.06REF	
E	2.35	2.55	0.091	0.102
E1	3.94	4.26	0.155	0.167
L	0.9	1.1	0.035	0.047
b	0.35	0.52	0.013	0.197
b1	0.4	0.58	0.016	0.023
c	0.35	0.44	0.014	0.017
e	Type:1.5		Type:0.05	
e1	Type:3.0		Type:0.115	



Packaging Type: TO-92 Unit:mm(inch)

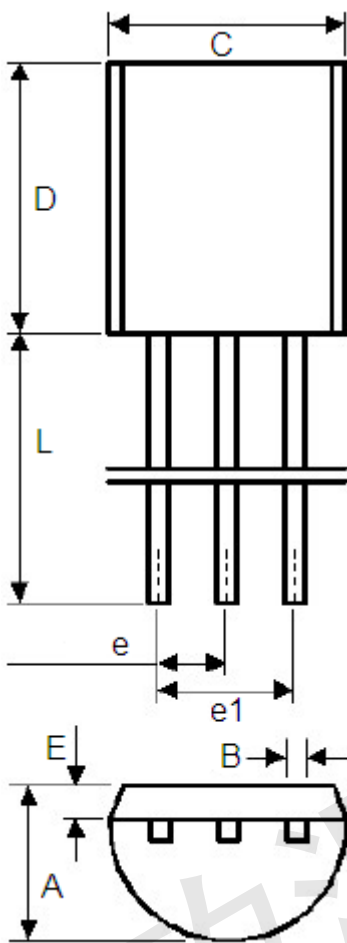

	Min	Max	Min	Max
A	3.4	3.7	0.1338	0.1457
B	0.36	0.5	0.0142	0.0167
C	4.35	4.7	0.1712	0.1850
D	4.35	4.7	0.1712	0.1850
E	0.9	1.5	0.0354	0.059
e	1.17	1.37	0.046	0.0539
e1	2.39	2.69	0.094	0.1059
L	12	16	0.4724	0.6299



Packaging Type: TO-92 taping package Unit:mm(inch)

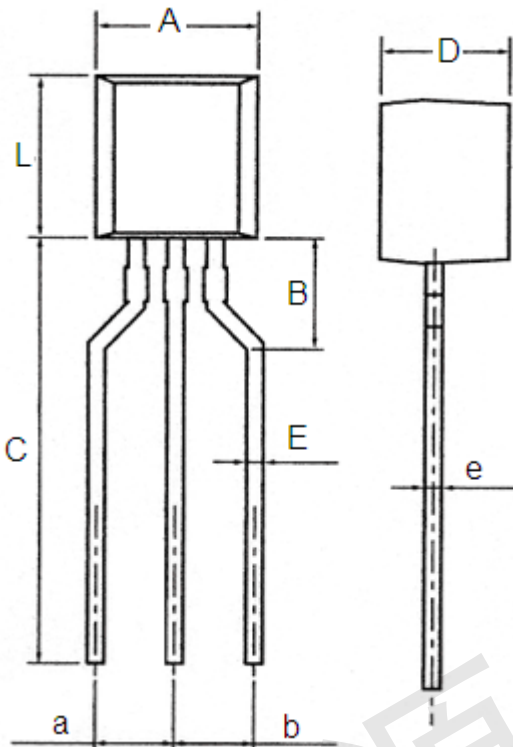

	Min	Max	Min	Max
A	4.35	4.7	0.1712	0.1850
B	3.25	3.75	0.1279	0.1476
C	13.2	13.8	0.5197	0.5433
D	3.4	3.7	0.1338	0.1457
E	0.4	0.55	0.0157	0.0216
a	2.3	2.7	0.0905	0.1063
b	2.3	2.7	0.0905	0.1063
e	0.36	0.5	0.0142	0.0167
L	4.35	4.7	0.1712	0.1850





- The information described herein is subject to change without notice.
- ShenZhen ChipSourceTek Technology Co.,Ltd. is not responsible for any problems caused by circuits or diagrams described herein whose related industrial properties, patents, or other rights belong to third parties. The application circuit examples explain typical applications of the products, and do not guarantee the success of any specific mass-production design.
- Use of the information described herein for other purposes and/or reproduction or copying without the express permission of ShenZhen ChipSourceTek Technology Co.,Ltd. is strictly prohibited.
- The products described herein cannot be used as part of any device or equipment affecting the human body, such as exercise equipment, medical equipment, security systems, gas equipment, or any apparatus installed in airplanes and other vehicles, without prior written permission of ShenZhen ChipSourceTek Technology Co.,Ltd..
- Although ShenZhen ChipSourceTek Technology Co.,Ltd. exerts the greatest possible effort to ensure high quality and reliability, the failure or malfunction of semiconductor products may occur. The user of these products should therefore give thorough consideration to safety design, including redundancy, fire-prevention measures, and malfunction prevention, to prevent any accidents, fires, or community damage that may ensue.