



### MOT50N06C/MOT50N06D N-CHANNEL MOSFET

#### ■ MOT50N06C/D PRODUCT CHARACTERISTICS

VDSS	60V
R <sub>DS(on)</sub> Typ(@V <sub>GS</sub> =10 V)	13mΩ
ID	50A

#### ■ MOT50N06C/D Pin Configuration

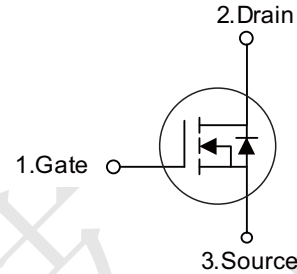

#### ■ MOT50N06C/D APPLICATIONS

- \* Switching applications

#### ■ MOT50N06C/D FEATURES

- \* High Switching Speed
- \* Improved dv/dt capability

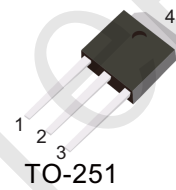

#### ■ MOT50N06C/D ORDER INFORMATION

Order codes		Package	Packing
Halogen-Free	Halogen		
N/A	MOT50N06D	TO-252	2500 pieces /Reel
N/A	MOT50N06C	TO-251	70 pieces/Tube

#### ■ MOT50N06C/D ABSOLUTE MAXIMUM RATINGS

PARAMETER	SYMBOL	RATINGS	UNIT	
Drain-Source Voltage	V <sub>DSS</sub>	60	V	
Gate-Source Voltage	V <sub>GSS</sub>	±20	V	
Continuous Drain Current	I <sub>D</sub>	50	A	
Pulsed Drain Current (Note 2)	I <sub>DM</sub>	150	A	
Avalanche Energy	E <sub>AS</sub>	92	mJ	
Single Pulsed (Note 3)				
Peak Diode Recovery dv/dt	dv/dt	10	V/ns	
Power Dissipation	TO-251/TO-252	P <sub>D</sub>	46	W
Junction Temperature	T <sub>J</sub>	+150	°C	
Operation and Storage Temperature	T <sub>STG</sub>	-55 ~ +150	°C	

Notes: 1. Absolute maximum ratings are those values beyond which the device could be permanently damaged.

Absolute maximum ratings are stress ratings only and functional device operation is not implied.

2. Repetitive Rating : Pulse width limited by maximum junction temperature.

3. L=43mH, I<sub>AS</sub>=43A, V<sub>DD</sub>=25V, R<sub>G</sub>=20Ω, Starting T<sub>J</sub>=25°C

4. I<sub>SD</sub> ≤ 30A, V<sub>DS</sub>=0V, di/dt ≤ 200A/μs, V<sub>DD</sub> ≤ BV<sub>DSS</sub>, Starting T<sub>J</sub> = 25°C

#### ■ MOT50N06C/D THERMAL DATA

PARAMETER	SYMBOL	RATING	UNIT
Junction to Ambient	θ <sub>JA</sub>	100	°C/W
Junction to Case	θ <sub>JC</sub>	2.7 (Note)	°C/W



■ MOT50N06C/D ELECTRICAL CHARACTERISTICS (T<sub>c</sub>=25°C, unless otherwise specified)

PARAMETER	SYMBOL	TEST CONDITIONS	MIN	TYP	MAX	UNIT
<b>OFF CHARACTERISTICS</b>						
Drain-Source Breakdown Voltage	BV <sub>DSS</sub>	V <sub>GS</sub> =0V, I <sub>D</sub> =250μA	60			V
Drain-Source Leakage Current	I <sub>DSS</sub>	V <sub>DS</sub> =60V, V <sub>GS</sub> =0V			10	μA
Gate-Source Leakage Current	Forward	V <sub>GS</sub> =20V, V <sub>DS</sub> =0V			100	nA
	Reverse	V <sub>GS</sub> =-20V, V <sub>DS</sub> =0V			-100	nA
<b>ON CHARACTERISTICS</b>						
Gate Threshold Voltage	V <sub>GS(TH)</sub>	V <sub>DS</sub> =V <sub>GS</sub> , I <sub>D</sub> =250μA	1.0		2.5	V
Static Drain-Source On-State Resistance	R <sub>DS(ON)</sub>	V <sub>GS</sub> =10V, I <sub>D</sub> =25A		13	18	mΩ
<b>DYNAMIC CHARACTERISTICS</b>						
Input Capacitance	C <sub>ISS</sub>			2500		pF
Output Capacitance	C <sub>OSS</sub>	V <sub>GS</sub> =0V, V <sub>DS</sub> =25V, f=1MHz		230		pF
Reverse Transfer Capacitance	C <sub>RSS</sub>			200		pF
<b>SWITCHING CHARACTERISTICS</b>						
Total Gate Charge	Q <sub>G</sub>	V <sub>DS</sub> =50V, V <sub>GS</sub> =10V, I <sub>D</sub> =1.3A I <sub>G</sub> =3mA (Note1,2)		7.2		nC
Gate-Source Charge	Q <sub>GS</sub>			0.4		nC
Gate-Drain Charge	Q <sub>GD</sub>			0.8		nC
Turn-On Delay Time	t <sub>D(ON)</sub>	V <sub>DS</sub> =30V, V <sub>GS</sub> =10V, I <sub>D</sub> =50A, R <sub>G</sub> =25Ω (Note1,2)		18		ns
Turn-On Rise Time	t <sub>r</sub>			46		ns
Turn-Off Delay Time	t <sub>D(OFF)</sub>			202		ns
Turn-Off Fall Time	t <sub>f</sub>			116		ns
<b>DRAIN-SOURCE DIODE CHARACTERISTICS AND MAXIMUM RATINGS</b>						
Maximum Continuous Drain-Source Diode Forward Current	I <sub>S</sub>				50	A
Maximum Pulsed Drain-Source Diode Forward Current	I <sub>SM</sub>				150	A
Drain-Source Diode Forward Voltage	V <sub>SD</sub>	I <sub>S</sub> =50A, V <sub>GS</sub> =0V			1.5	V
Body Diode Reverse Recovery Time	t <sub>rr</sub>	I <sub>S</sub> =30A, V <sub>GS</sub> =0V,		50		ns
Body Diode Reverse Recovery Charge	Q <sub>rr</sub>	dI <sub>S</sub> /dt=100A/μs		80		nC

Notes: 1. Pulse Test: Pulse Width ≤ 300μs, Duty Cycle ≤ 2%.

2. Essentially independent of operating temperature.



■ MOT50N06C/D TEST CIRCUITS AND WAVEFORMS

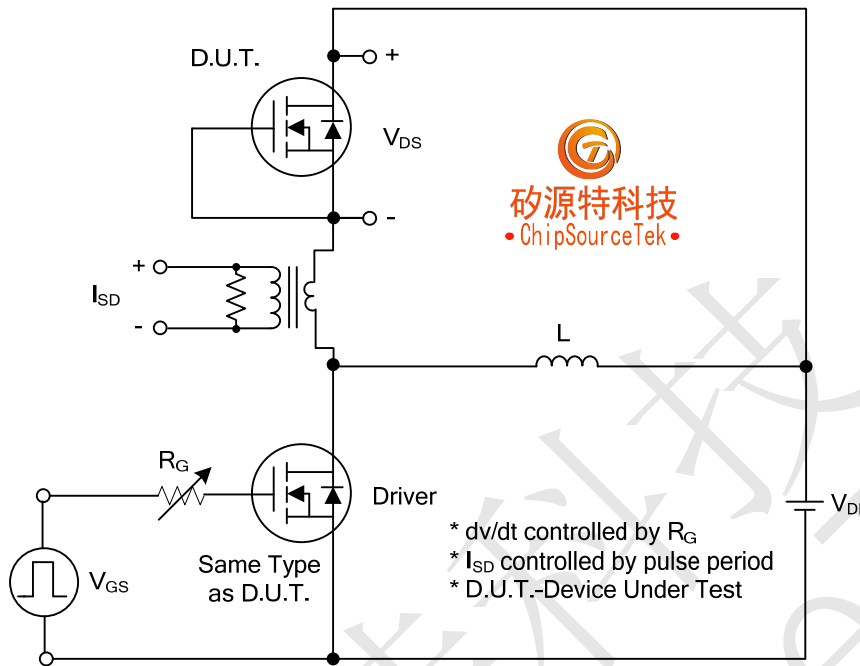

Peak Diode Recovery dv/dt Test Circuit

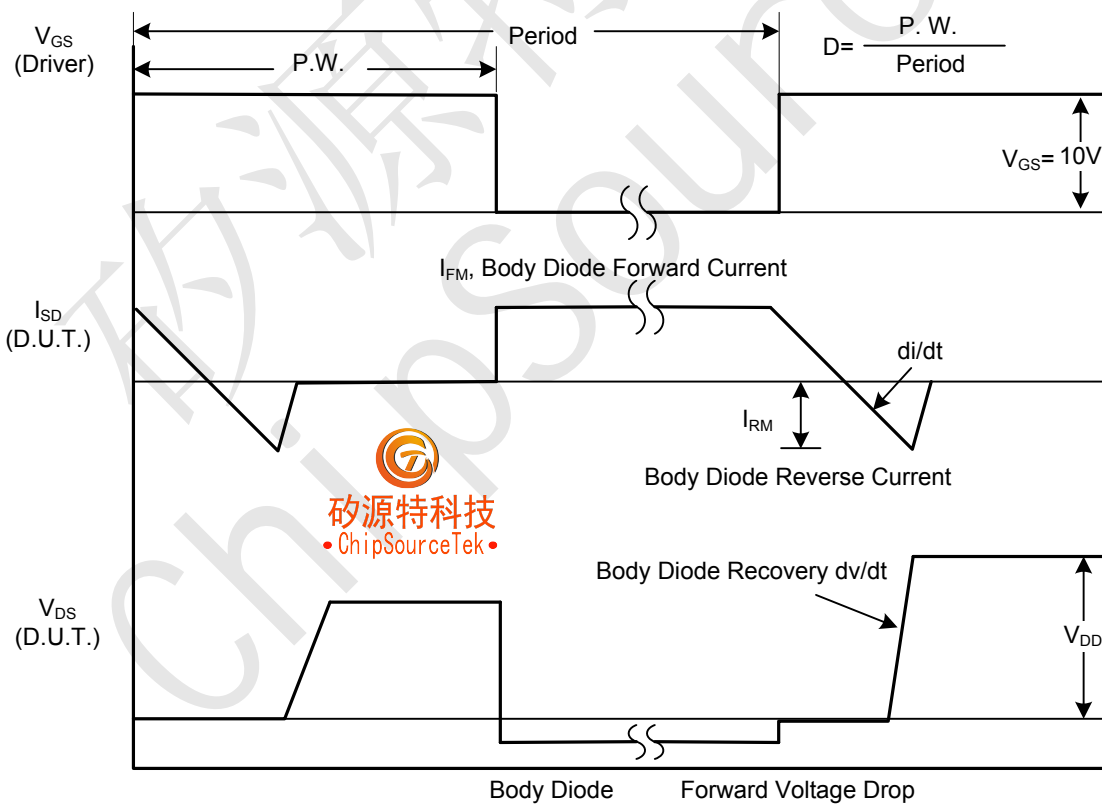

Peak Diode Recovery dv/dt Waveforms



■ MOT50N06C/D TEST CIRCUITS AND

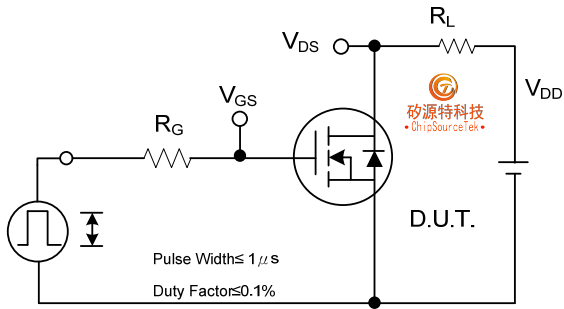

**Fig. 2A Switching Test Circuit**

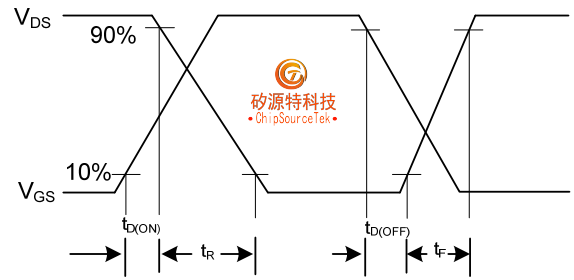

**Fig. 2B Switching Waveforms**

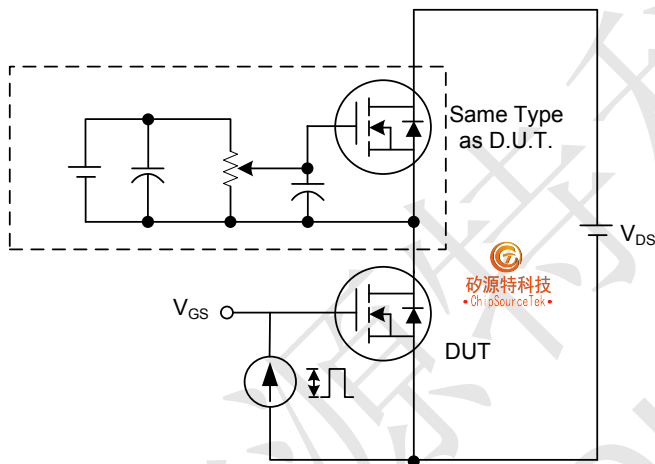

**Fig. 3A Gate Charge Test Circuit**

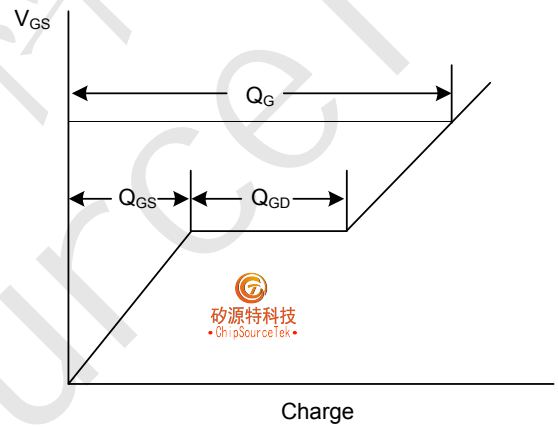

**Fig. 3B Gate Charge Waveform**

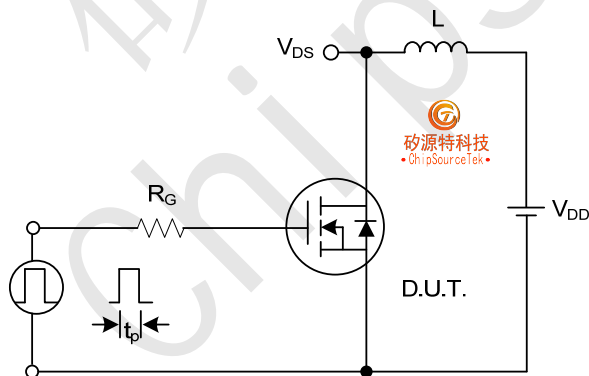

**Fig. 4A Unclamped Inductive Switching Test Circuit**

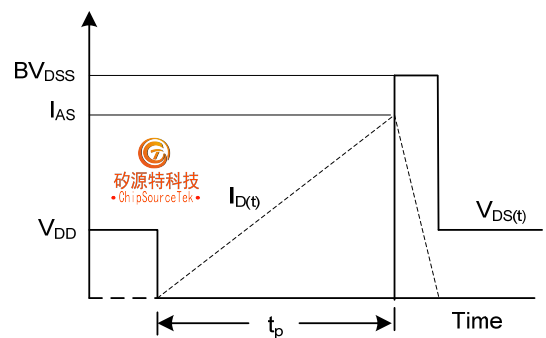

**Fig. 4B Unclamped Inductive Switching Waveforms**



## ■ MOT50N06C/D TYPICAL CHARACTERISTICS

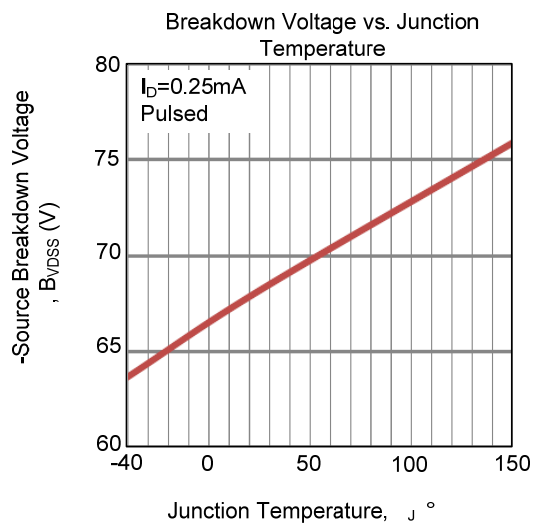
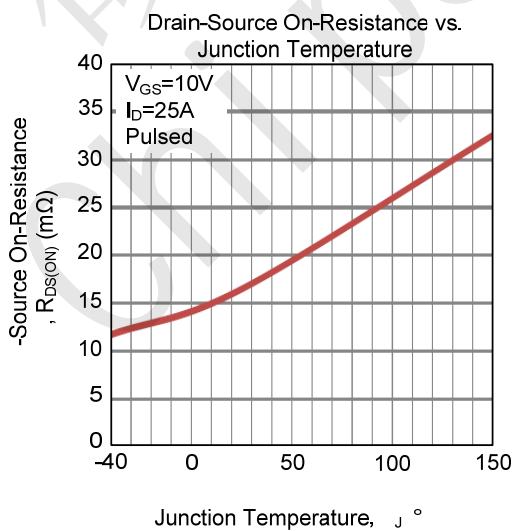
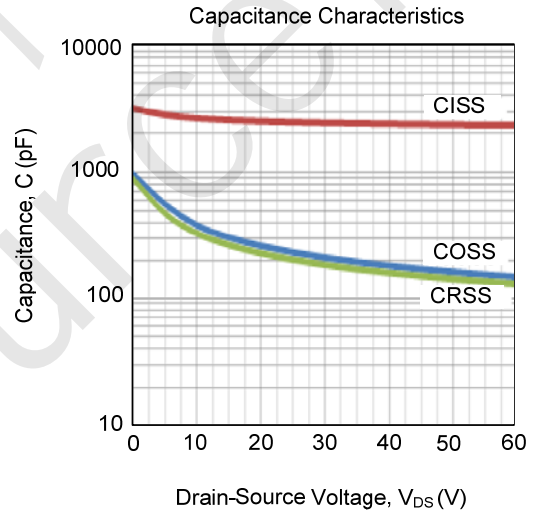
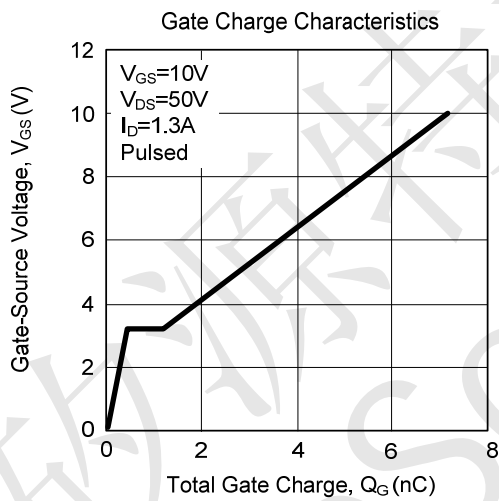
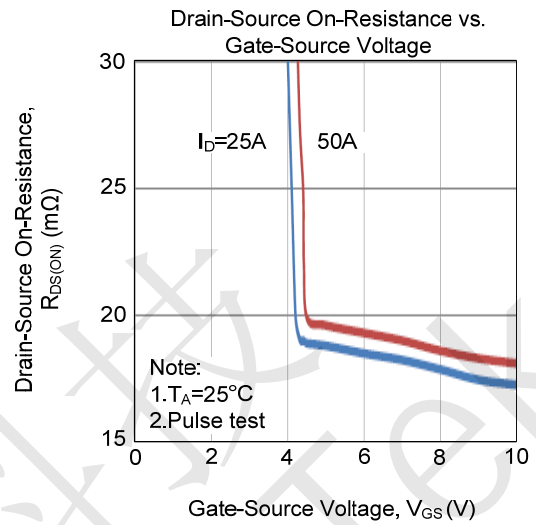
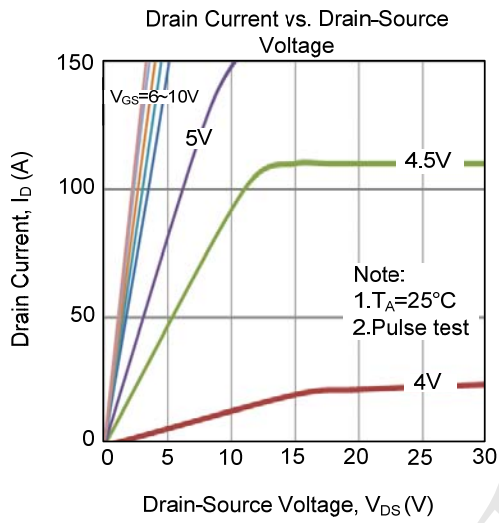



### ■ MOT50N06C/D TYPICAL CHARACTERISTICS(Cont.)

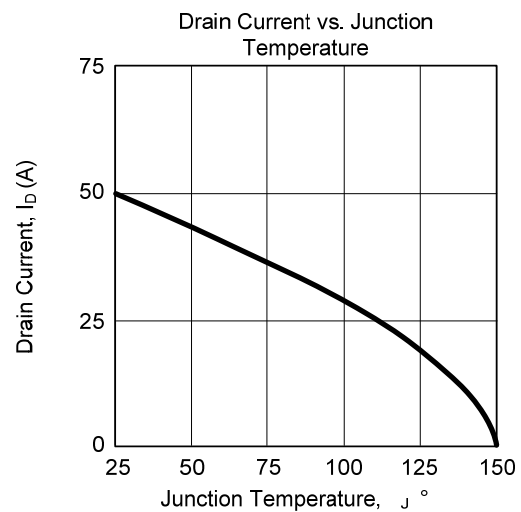
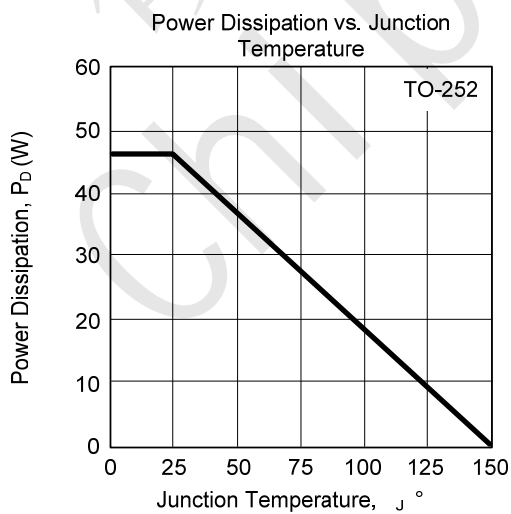
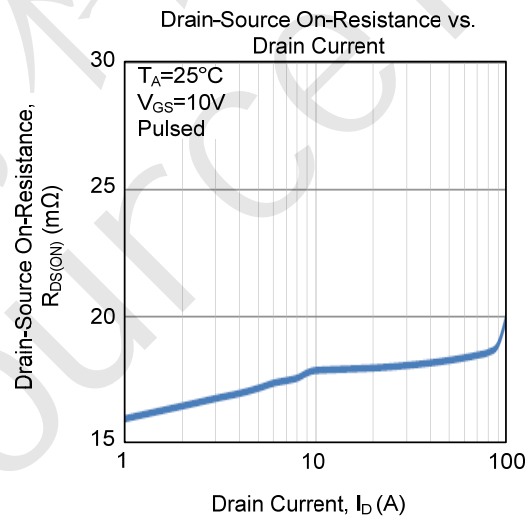
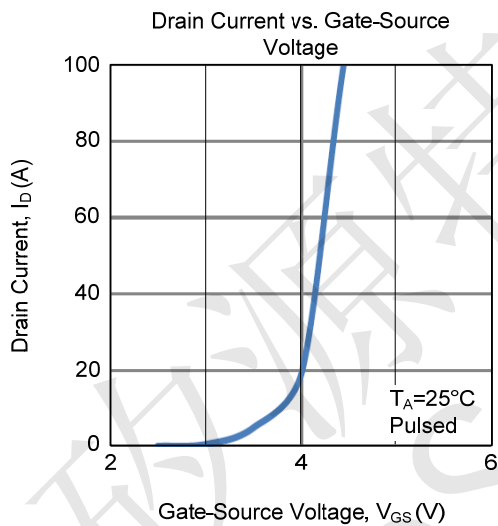
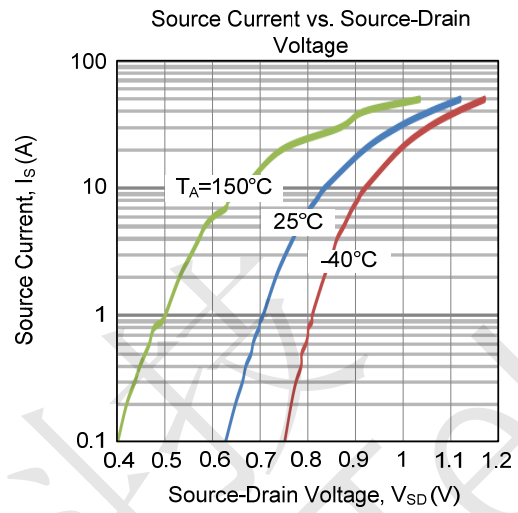
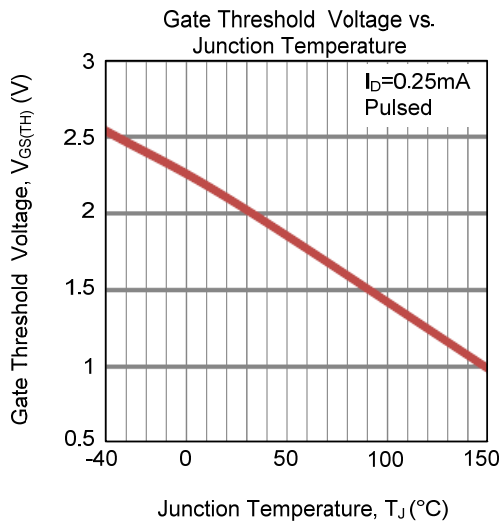



■ MOT50N06C/D TO-252 PACKAGE OUTLINE DIMENSIONS

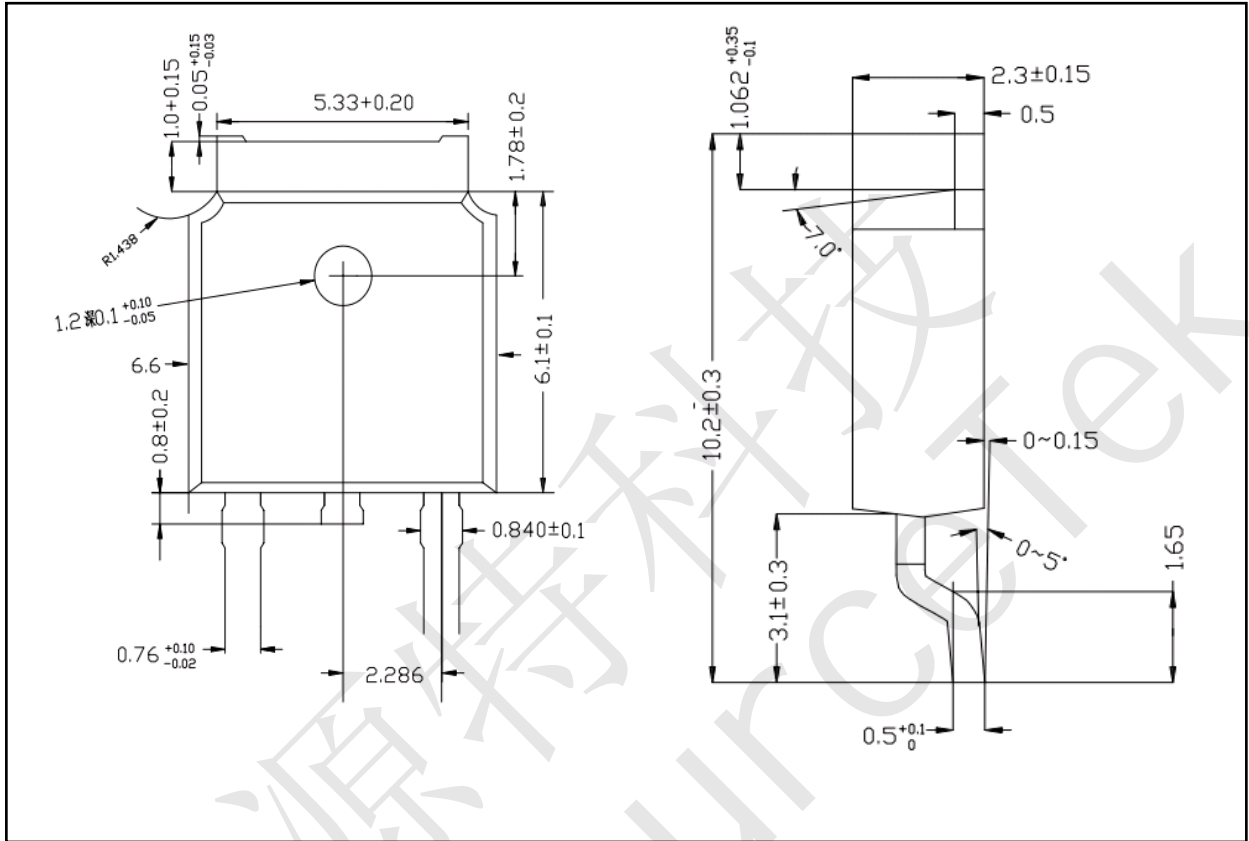



■ MOT50N06C/D TO-251 PACKAGE OUTLINE DIMENSIONS

