



Dual N-Channel Enhancement Mode Power MOSFET **MX8205S**

DESCRIPTION

The MX8205S uses advanced trench technology to provide excellent $R_{DS(ON)}$ and low gate charge. It can be used in a wide variety of applications.

GENERAL FEATURES

- $V_{DS}=20V$, $I_D=5A$
 $R_{DS(ON)}(Typ.)=19m\Omega$ @ $V_{GS}=4.5V$
 $R_{DS(ON)}(Typ.)=20m\Omega$ @ $V_{GS}=3.9V$
 $R_{DS(ON)}(Typ.)=30m\Omega$ @ $V_{GS}=2.5V$
- Surface Mount Package
- Advanced trench cell design

APPLICATION

- Battery protection
- Load switch

PINOUT

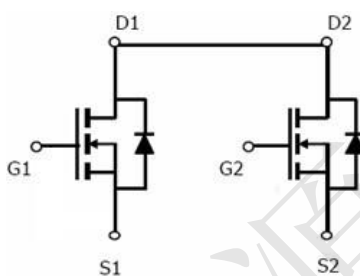

Schematic diagram

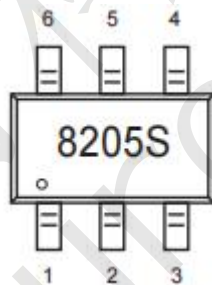

Marking and Pin Assignment

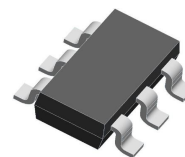

SOT23-6L top view

ORDERING INFORMATION

Part Number	Storage Temperature	Package	Devices Per Reel
MX8205S	-55°C to 150°C	SOT23-6L	-

ABSOLUTE MAXIMUM RATINGS ($T_A=25^\circ C$ unless otherwise noted)

Parameter	Symbol	Limit	Unit
Drain-Source Voltage	V_{DS}	20	V
Gate-Source Voltage	V_{GS}	± 12	V
Drain Current-Continuous ^(Note1)	I_D	5	A
Pulsed Drain Current ^(Note2)	I_{DM}	20	A
Total Power Dissipation ^(Note1)	P_{tot}	0.83	W
Operating Junction and Storage Temperature Range	T_J, T_{STG}	-55 to 150	°C
Diode Forward Current ^(Note1)	I_S	5	A

THERMAL RESISTANCE

Thermal Resistance, Junction-to-Ambient ^(Note1)	$R_{\theta JA}$	150	°C/W
--	-----------------	-----	------

Note 1. Surface Mounted on 1 in² pad area, $t \leq 10$ sec.

Note 2. Pulse Width $\leq 300\mu s$, duty cycle $\leq 2\%$.



Dual N-Channel Enhancement Mode Power MOSFET **MX8205S**



ELECTRICAL CHARACTERISTICS ($T_A=25^\circ\text{C}$ unless otherwise noted)

Parameter	Symbol	Conditions	Min	Typ	Max	Unit
Off Characteristics						
Drain-Source Breakdown Voltage	BV_{DSS}	$V_{GS}=0V, I_D=250\mu A$	20	-	-	V
Zero Gate Voltage Drain Current	I_{DSS}	$V_{DS}=20V, V_{GS}=0V$	-	-	1	μA
Gate-Body Leakage Current	I_{GSS}	$V_{GS}=\pm 10V, V_{DS}=0V$	-	-	± 100	nA
On Characteristics						
Gate Threshold Voltage	$V_{GS(th)}$	$V_{DS}=V_{GS}, I_D=250\mu A$	0.5	0.87	1.2	V
Drain-Source On-State Resistance ^(Note3)	$R_{DS(on)}$	$V_{GS}=4.5V, I_D=5A$	-	19	24	$m\Omega$
		$V_{GS}=3.9V, I_D=4.5A$	-	20	25	$m\Omega$
		$V_{GS}=2.5V, I_D=3.5A$	-	30	35	$m\Omega$
Dynamic Characteristics ^(Note4)						
Input Capacitance	C_{iss}	$V_{DS}=8V, V_{GS}=0V, F=1.0MHz$	-	802	-	pF
Output Capacitance	C_{oss}		-	153	-	pF
Reverse Transfer Capacitance	C_{rss}		-	122	-	pF
Switching Characteristics ^(Note4)						
Turn-on Delay Time	$t_{d(on)}$	$V_{DS}=10V, I_{DS}=1A, V_{GS}=4.5V, R_G=1.6\Omega, R_{GEN}=10\Omega$	-	18	-	nS
Turn-on Rise Time	t_r		-	5	-	nS
Turn-Off Delay Time	$t_{d(off)}$		-	43.8	-	nS
Turn-Off Fall Time	t_f		-	20	-	nS
Total Gate Charge	Q_g	$V_{DS}=10V, I_{DS}=4A, V_{GS}=4.5V$	-	10.5	-	nC
Gate-Source Charge	Q_{gs}		-	2	-	nC
Gate-Drain Charge	Q_{gd}		-	2.5	-	nC
Drain-Source Diode Characteristics						
Diode Forward Voltage ^(Note3)	V_{SD}	$V_{GS}=0V, I_{SD}=1A$	-	-	1.2	V

Note 3. Pulse Test: Pulse Width $\leq 300\mu s$, Duty Cycle $\leq 2\%$.

Note 4. Guaranteed by design, not subject to product.



TYPICAL ELECTRICAL AND THERMAL CHARACTERISTICS

Figure 1. Power Capability

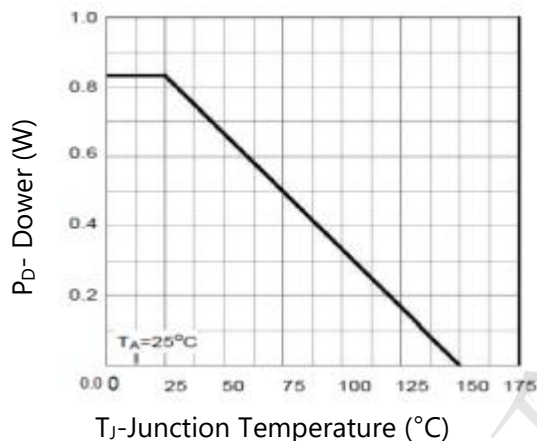

Figure 2. Current Capability

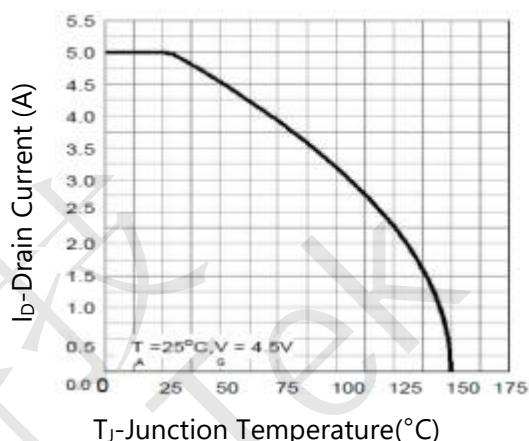

Figure 3. Safe Operation Area

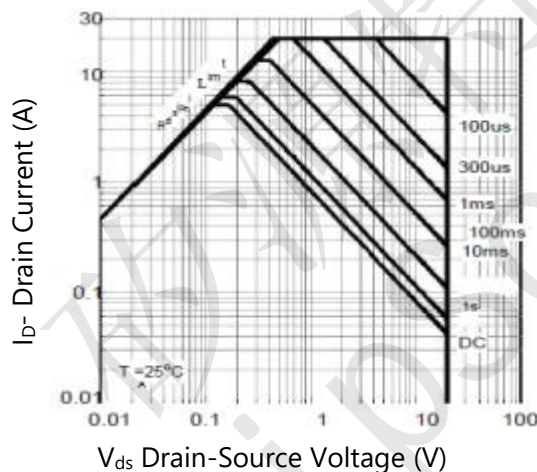

Figure 4. Transient Thermal Impedance

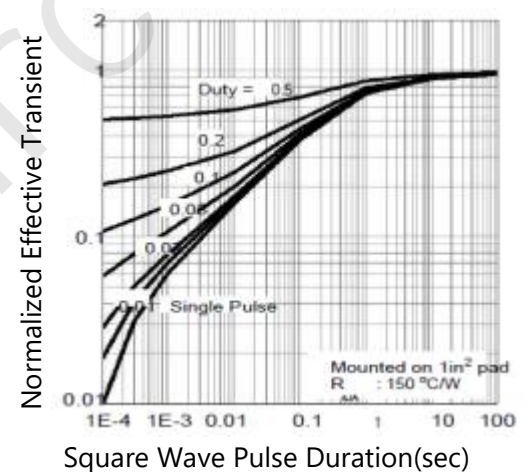

Figure 5. Output Characteristics

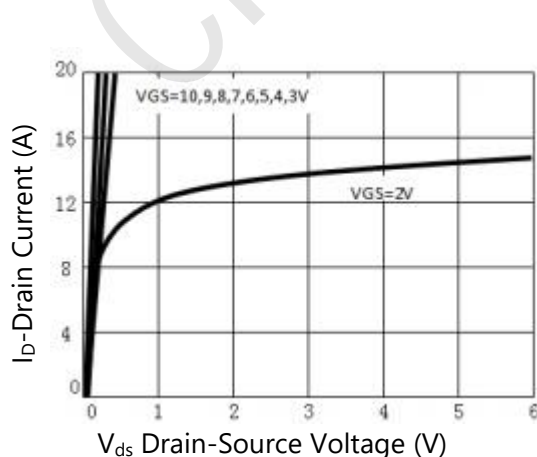
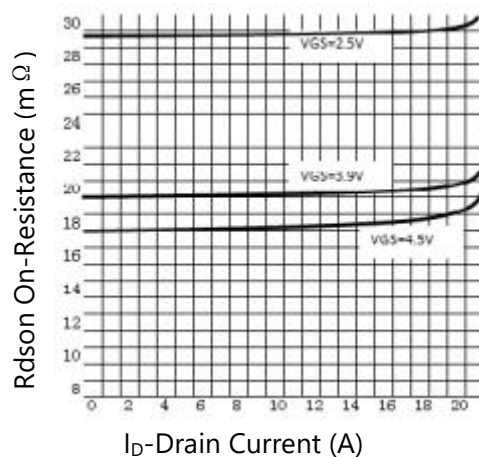

Figure 6. R_{ds(on)} vs Drain Current





TYPICAL ELECTRICAL AND THERMAL CHARACTERISTICS

Figure 7. Transfer Characteristics

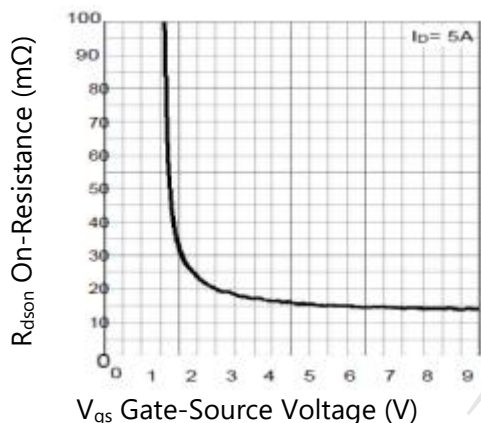

Figure 8. Normalized Threshold Voltage

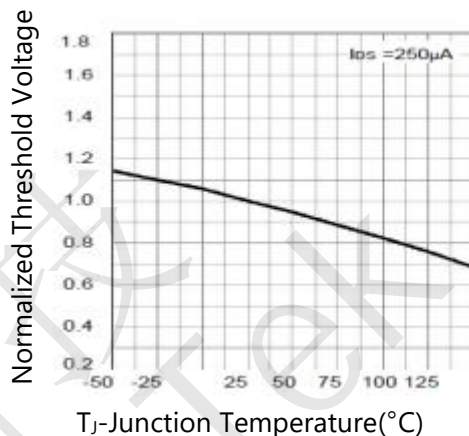

Figure 9. Normalized On Resistance

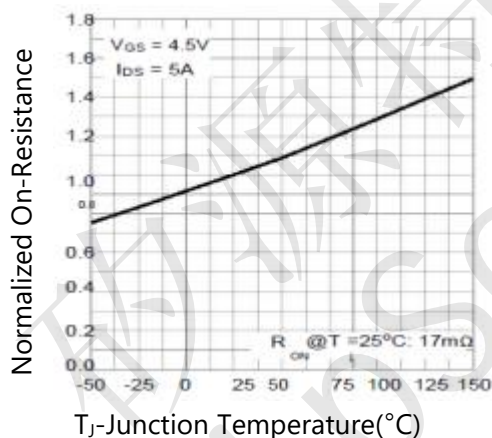

Figure 10. Diode Forward Current

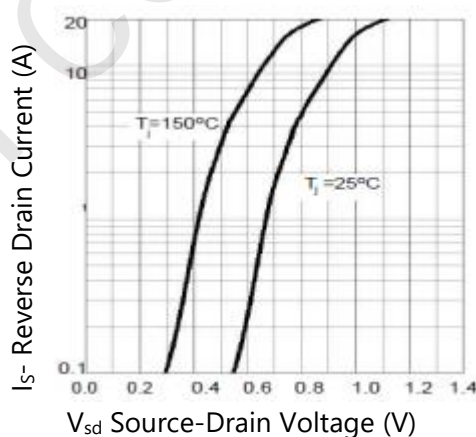

Figure 11. Capacitance

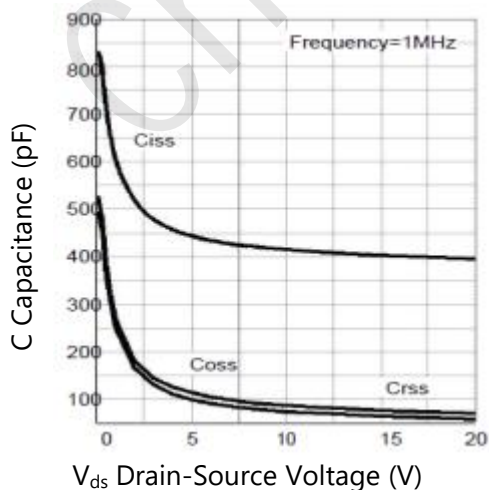
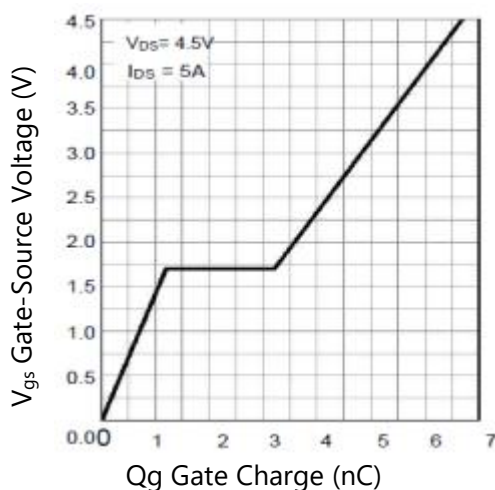

Figure 12. Gate Charge





Dual N-Channel Enhancement Mode Power MOSFET **MX8205S**



PACKAGE INFORMATION

SOT23-6L

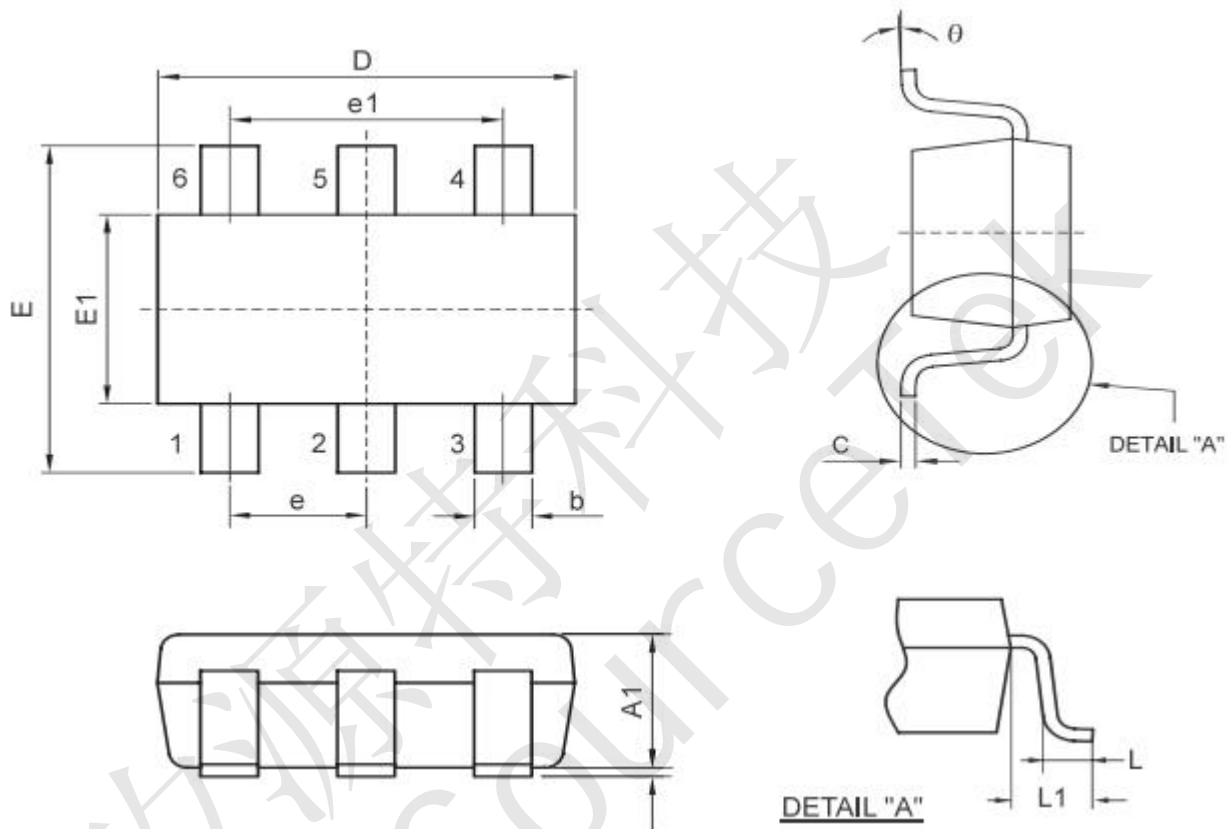

Symbol	Dimensions In Millimeters		Dimensions In Inches	
	Min.	Max.	Min.	Max.
D	2.692	3.099	0.106	0.122
E	2.591	3.000	0.102	0.118
E1	1.397	1.803	0.055	0.071
e	0.950 REF.		0.037 REF.	
e1	1.900 REF.		0.075 REF.	
b	0.300	0.500	0.012	0.020
C	0.080	0.200	0.003	0.008
A	0.000	0.100	0.000	0.004
A1	0.700	1.200	0.028	0.048
L	0.300	0.600	0.012	0.024
L1	0.600 REF.		0.023 REF.	
θ	0°	9°	0°	9°