



PE3N50K N-Channel Enhancement Mode Power MOSFET

PE3N50K Description

The PE3N50K uses advanced technology to provide excellent $R_{DS(ON)}$ and low gate charge. It can be used in a wide variety of applications.

PE3N50K General Features

- $V_{DS}=500V, I_D=3A$

$$R_{DS(ON)} < 3\Omega @ V_{GS}=10V$$

- High Power and current handing capability
- Lead free product is acquired
- Surface Mount Package

PE3N50K Application

- Synchronous Rectification
- LED Power Supply
- DC/DC, AC/DC Converter

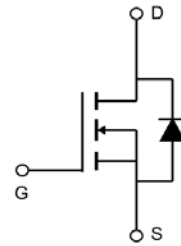

Schematic diagram

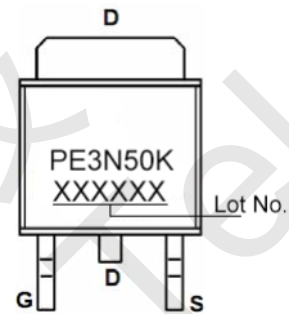

Marking and pin assignment

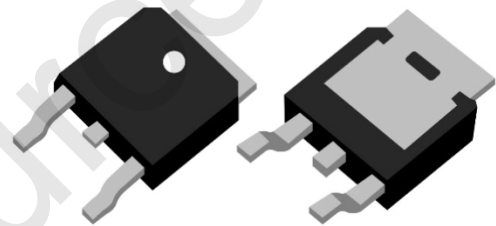

TO-252-2L

PE3N50K Absolute Maximum Ratings (TC=25°C unless otherwise noted)

Parameter	Symbol	Rating	Unit
Drain-Source Voltage	V_{DS}	500	V
Gate-Source Voltage	V_{GS}	± 30	V
Drain Current-Continuous	I_D	3	A
Drain Current-Continuous (TC=100°C)	I_D	2	A
Pulsed Drain Current (Note 1)	I_{DM}	9	A
Maximum Power Dissipation	P_D	68	W
Single Pulsed Avalanche Energy (L=10.6mH)	E_{AS}	260	mJ
Operating Junction and Storage Temperature Range	T_J, T_{STG}	-55 To 175	°C

PE3N50K Thermal Characteristic

Thermal Resistance, Junction-to-Case	$R_{\theta JC}$	2.2	°C/W
Thermal Resistance, Junction-to-Ambient (Note 2)	$R_{\theta JA}$	55	°C/W



PE3N50K Electrical Characteristics (TC=25°C unless otherwise noted)

Parameter	Symbol	Condition	Min	Typ	Max	Unit
Off Characteristics						
Drain-Source Breakdown Voltage	BV_{DSS}	$V_{GS}=0V, I_D=250\mu A$	500	-	-	V
Zero Gate Voltage Drain Current	I_{DSS}	$V_{DS}=500V, V_{GS}=0V$	-	-	1	μA
Gate-Body Leakage Current	I_{GSS}	$V_{GS}=\pm 30V, V_{DS}=0V$	-	-	± 100	nA
On Characteristics (Note 3)						
Gate Threshold Voltage	$V_{GS(th)}$	$V_{DS}=V_{GS}, I_D=250\mu A$	2	3	4	V
Drain-Source On-State Resistance	$R_{DS(ON)}$	$V_{GS}=10V, I_D=1.5A$	-	2.5	3	Ω
Forward Transconductance	g_{FS}	$V_{DS}=40V, I_D=2.5A$	-	2.8	-	S
Dynamic Characteristics (Note 4)						
Input Capacitance	C_{iss}	$V_{DS}=25V, V_{GS}=0V,$ $F=1.0MHz$	-	355	-	pF
Output Capacitance	C_{oss}		-	10	-	pF
Reverse Transfer Capacitance (Note 4)	C_{rss}		-	2	-	pF
Switching Characteristics						
Turn-on Delay Time	$t_{d(on)}$	$V_{DS}=250V, I_D=3A,$ $V_{GS}=10V, R_G=25\Omega$	-	11	-	nS
Turn-on Rise Time	t_r		-	19	-	nS
Turn-Off Delay Time	$t_{d(off)}$		-	20.5	-	nS
Turn-Off Fall Time	t_f		-	15	-	nS
Total Gate Charge	Q_g	$V_{DS}=400V, I_D=3A,$ $V_{GS}=10V$	-	6.7	-	nC
Gate-Source Charge	Q_{gs}		-	1.7	-	nC
Gate-Drain Charge	Q_{gd}		-	2.7	-	nC
Drain-Source Diode Characteristics						
Diode Forward Voltage (Note 3)	V_{SD}	$V_{GS}=0V, I_S=3A$	-	-	1.2	V
Diode Forward Current (Note 2)	I_S		-	-	5	A
Body Diode Reverse Recovery Time	t_{rr}	$I_F=3A, di/dt=100A/\mu s$	-	134	-	nS
Body Diode Reverse Recovery Charge	Q_{rr}		-	0.89	-	μC

Notes:

1. Repetitive Rating: Pulse width limited by maximum junction temperature.
2. Surface Mounted on FR4 Board, $t \leq 10$ sec.
3. Pulse Test: Pulse Width $\leq 300\mu s$, Duty Cycle $\leq 2\%$.
4. Guaranteed by design, not subject to product.



PE3N50K Typical Electrical and Thermal Characteristics

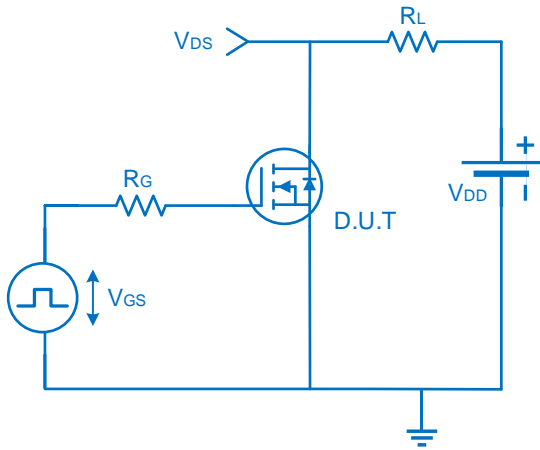

Figure 1 Switching Test Circuit

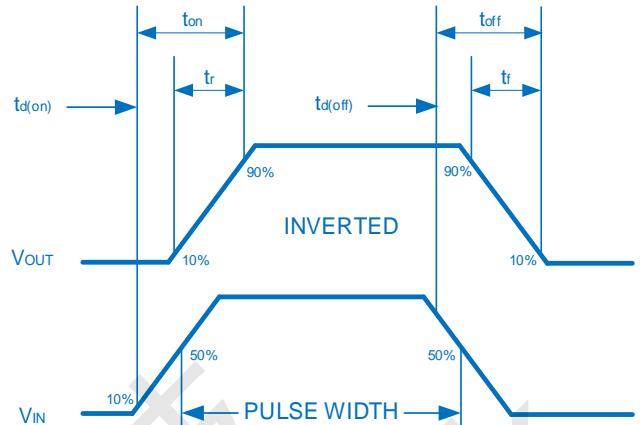

Figure 2 Switching Waveform

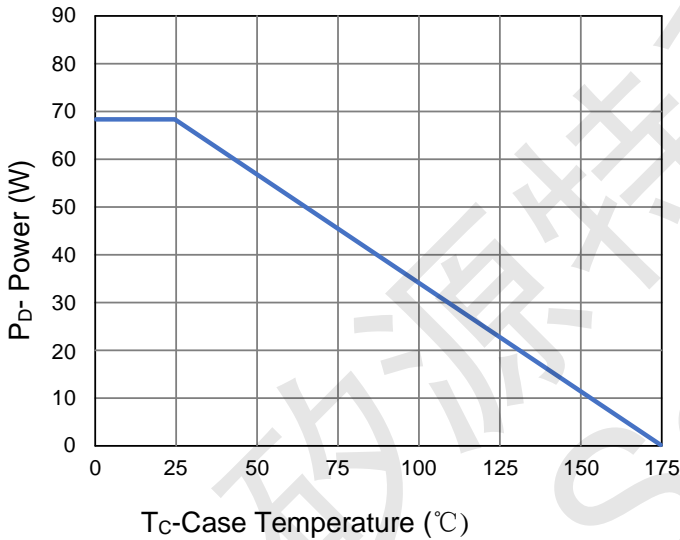

Figure 3 Power De-rating

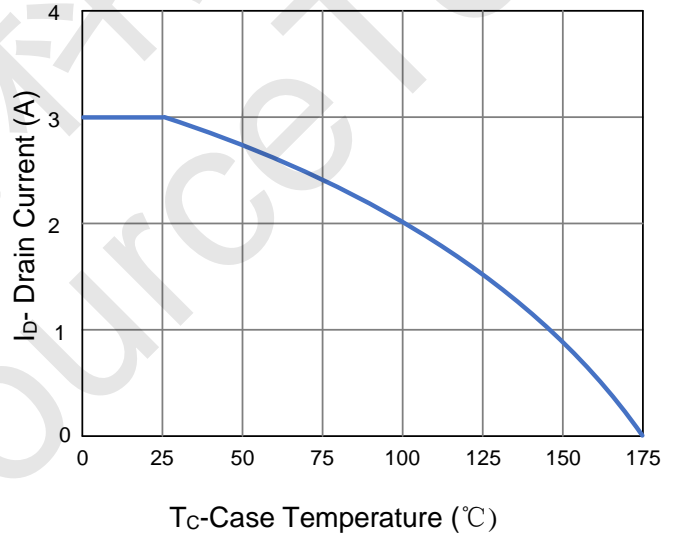

Figure 4 Drain Current

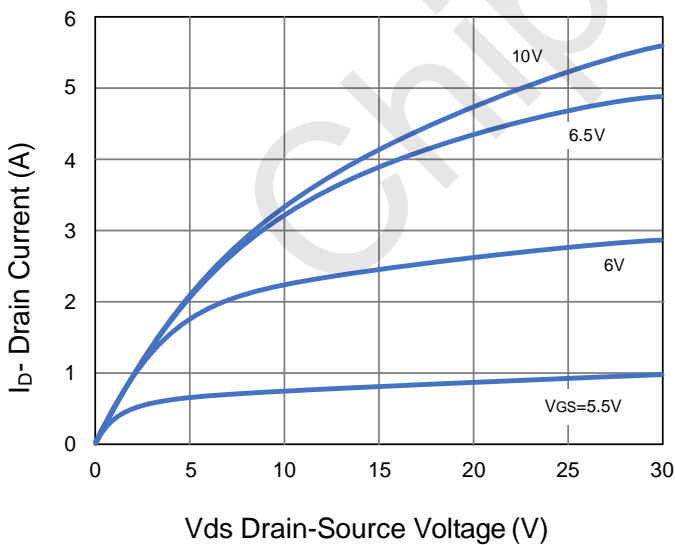

Figure 5 Output Characteristics

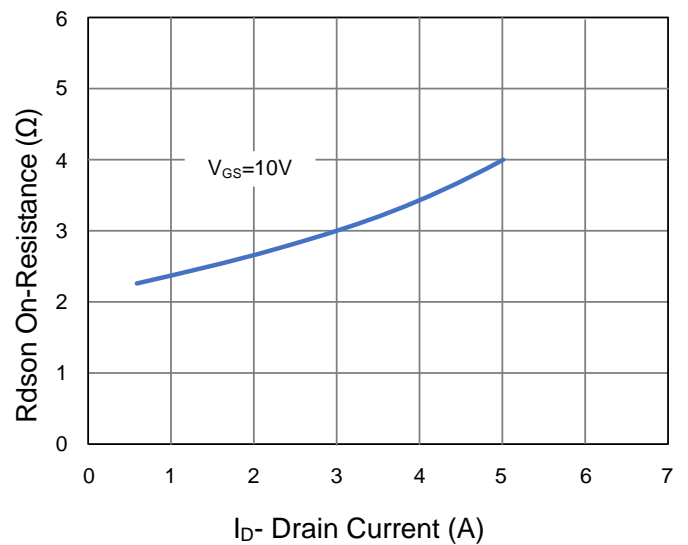

Figure 6 R_{dson} vs Drain Current

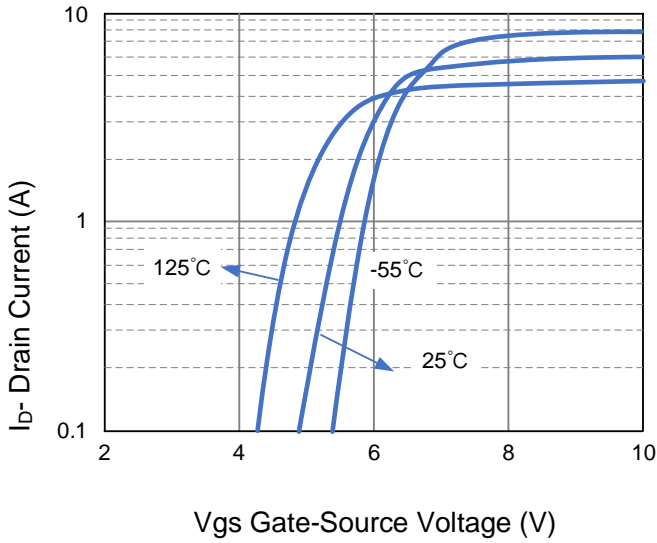

Figure 7 Transfer Characteristics

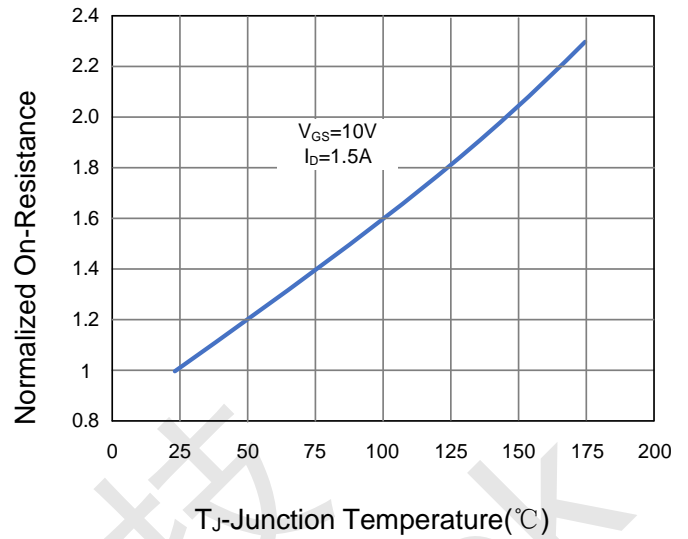

Figure 8 R_{dson} vs Junction Temperature

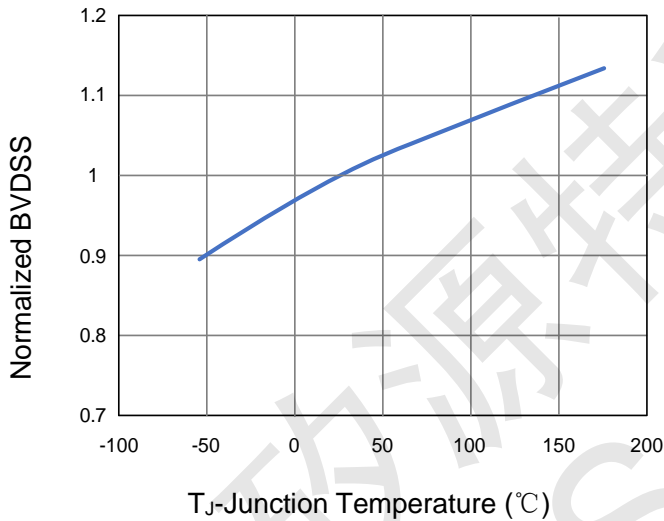

Figure 9 B_{vdss} vs T_J

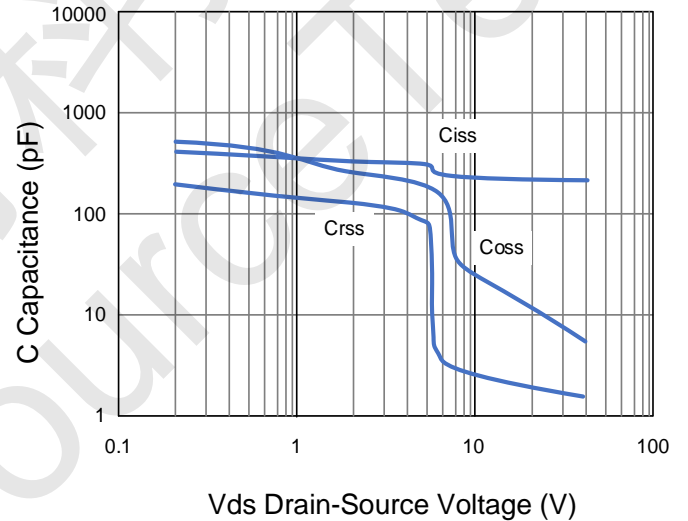

Figure 10 Capacitance vs V_{ds}

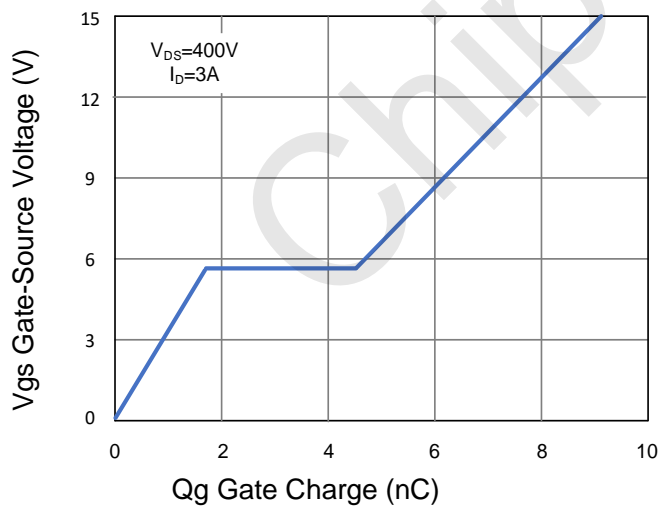

Figure 11 Gate Charge

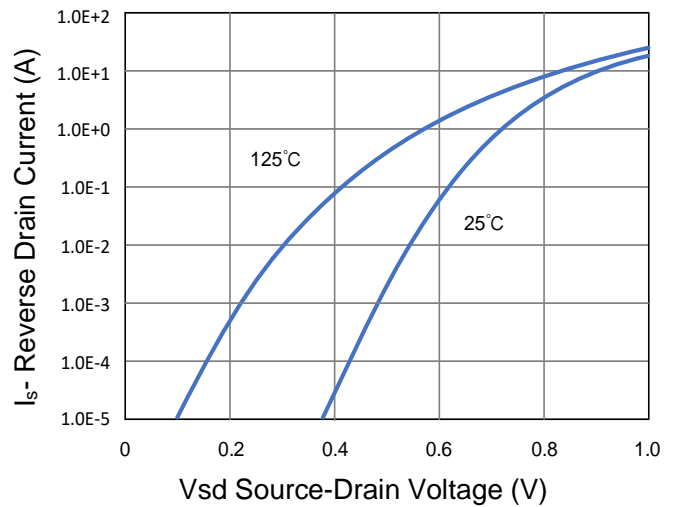

Figure 12 Source- Drain Diode Forward

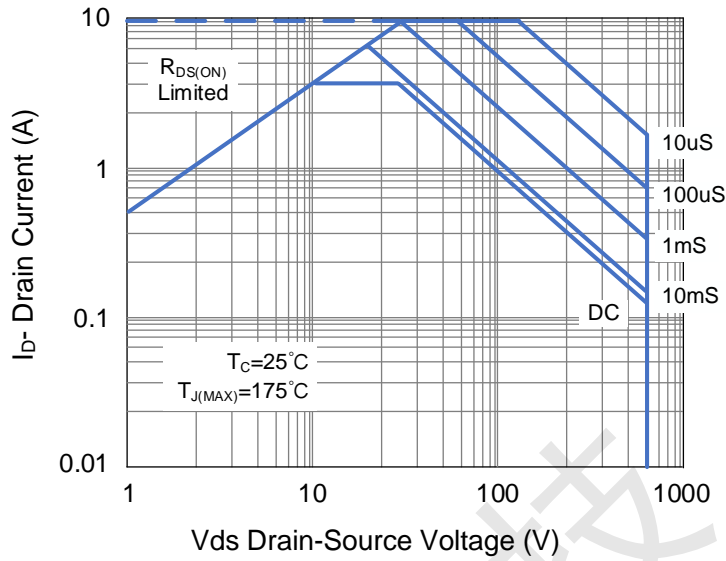

Figure 13 Safe Operation Area

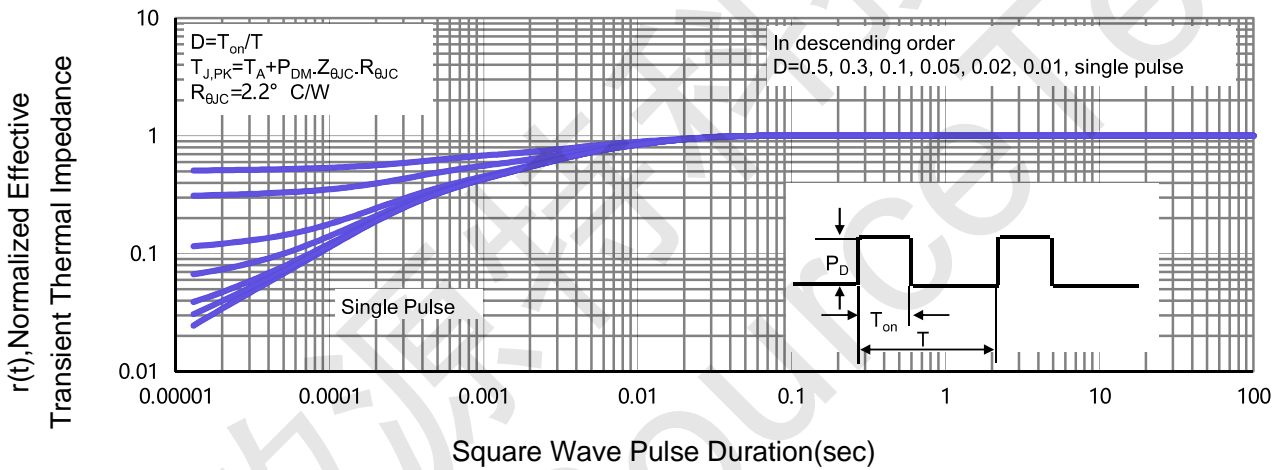
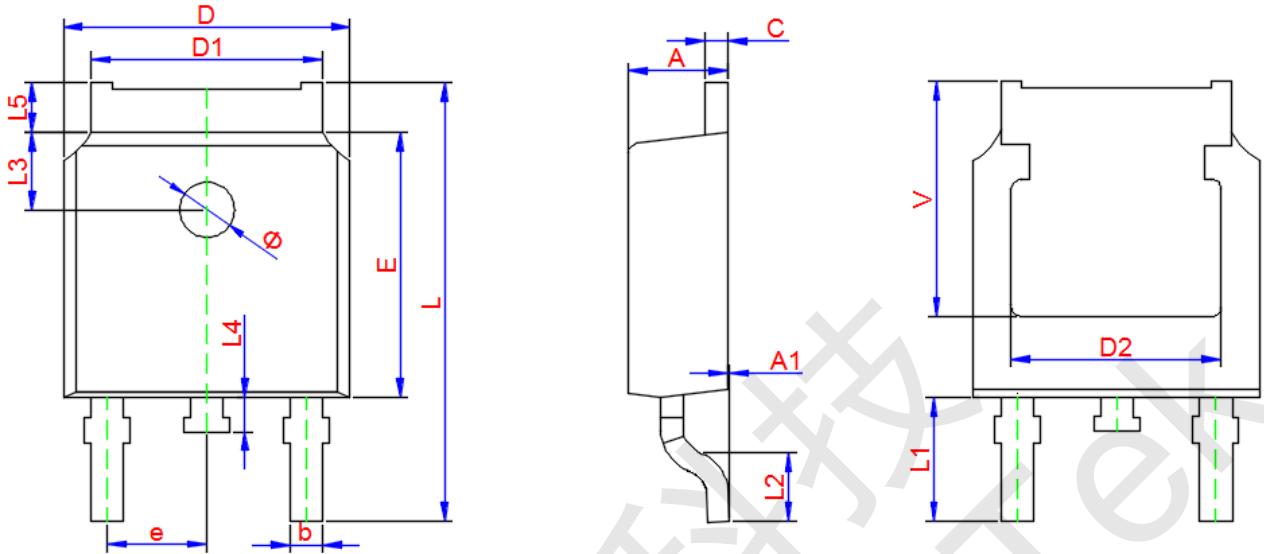

Figure 14 Normalized Maximum Transient Thermal Impedance



PE3N50K TO-252-2L Package Information



Symbol	Dimensions In Millimeters		
	Min.	Typ.	Max.
A	2.200	2.300	2.400
A1	0.000	--	0.127
b	0.660	0.760	0.860
D	6.500	6.600	6.700
D1	5.100	5.330	5.460
C	0.450	0.500	0.600
D2	4.830 TYP.		
E	6.000	6.100	6.200
e	2.186	2.286	2.386
L	9.800	10.100	10.400
L1	2.900 TYP.		
L2	1.400	1.500	1.600
L3	1.800 TYP.		
L4	0.600	0.800	1.000
L5	0.900	--	1.250
Φ	1.100.	--	1.300
V	5.350		