



PE73100G P-Channel Enhancement Mode Power MOSFET

PE73100G Description

The PE73100G uses advanced trench technology to provide excellent $R_{DS(ON)}$ and low gate charge. It can be used in a wide variety of applications.

PE73100G General Features

- $V_{DS} = -30V$, $I_D = -100A$

$$R_{DS(ON)} < 3.2m\Omega @ V_{GS} = -10V$$

$$R_{DS(ON)} < 5m\Omega @ V_{GS} = -4.5V$$

- High Power and current handling capability
- Lead free product is acquired
- Surface Mount Package

PE73100G Application

- PWM applications
- Load switch
- Power management

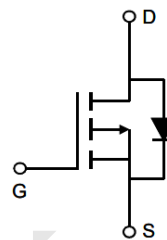

Schematic diagram

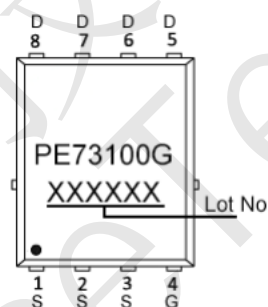

Marking and pin assignment

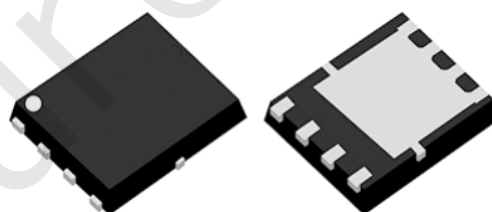

DFN5x6-8L

PE73100G Absolute Maximum Ratings (TC=25°C unless otherwise noted)

Parameter	Symbol	Rating	Unit
Drain-Source Voltage	V_{DS}	-30	V
Gate-Source Voltage	V_{GS}	± 20	V
Drain Current-Continuous	I_D	-100	A
Drain Current-Continuous (TC=100°C)	I_D	-72	A
Pulsed Drain Current (Note 1)	I_{DM}	-350	A
Maximum Power Dissipation	P_D	83	W
Single Pulsed Avalanche Energy (L=0.1mH)	E_{AS}	405	mJ
Operating Junction and Storage Temperature Range	T_J, T_{STG}	-55 To 150	°C

PE73100G Thermal Characteristic

Thermal Resistance, Junction-to-Case (Note 2)	$R_{\theta JC}$	1.5	°C/W
---	-----------------	-----	------



PE73100G P-Channel Enhancement Mode Power MOSFET

PE73100G Electrical Characteristics (TC=25°C unless otherwise noted)

Parameter	Symbol	Condition	Min	Typ	Max	Unit
Off Characteristics						
Drain-Source Breakdown Voltage	BV_{DSS}	$V_{GS}=0V, I_D=-250\mu A$	-30	-	-	V
Zero Gate Voltage Drain Current	I_{DSS}	$V_{DS}=-24V, V_{GS}=0V$	-	-	-1	μA
Gate-Body Leakage Current	I_{GSS}	$V_{GS}=\pm 20V, V_{DS}=0V$	-	-	± 100	nA
On Characteristics (Note 3)						
Gate Threshold Voltage	$V_{GS(th)}$	$V_{DS}=V_{GS}, I_D=-250\mu A$	-1.2	-1.6	-2.5	V
Drain-Source On-State Resistance	$R_{DS(on)}$	$V_{GS}=-10V, I_D=-20A$	-	2.7	3.2	m Ω
		$V_{GS}=-4.5V, I_D=-10A$	-	4	5	m Ω
Forward Transconductance	g_{FS}	$V_{DS}=-10V, I_D=-5A$	-	27	-	S
Dynamic Characteristics (Note 4)						
Input Capacitance	C_{iss}	$V_{DS}=-15V, V_{GS}=0V,$ $F=1.0MHz$	-	8000	-	pF
Output Capacitance	C_{oss}		-	800	-	pF
Reverse Transfer Capacitance (Note 4)	C_{rss}		-	630	-	pF
Gate Resistance	R_g	$V_{DS}=0V, V_{GS}=0V, F=1.0MHz$	-	1.7	-	Ω
Switching Characteristics						
Turn-on Delay Time	$t_{d(on)}$	$V_{DD}=-15V, I_D=-18A,$ $V_{GS}=-10V, R_G=6\Omega$	-	69	-	nS
Turn-on Rise Time	t_r		-	56	-	nS
Turn-Off Delay Time	$t_{d(off)}$		-	68	-	nS
Turn-Off Fall Time	t_f		-	16	-	nS
Total Gate Charge	Q_g	$V_{DS}=-15V, I_D=-20A, V_{GS}=-10V$	-	147	-	nC
Gate-Source Charge	Q_{gs}		-	25	-	nC
Gate-Drain Charge	Q_{gd}		-	28	-	nC
Drain-Source Diode Characteristics						
Diode Forward Voltage (Note 3)	V_{SD}	$V_{GS}=0V, I_S=-18A$	-	-	-1.2	V
Maximum Body-Diode Current	I_S				-100	A
Body Diode Reverse Recovery Time	t_{rr}	$I_F=-18A, dI/dt=100A/\mu s$	-	25	-	nS
Body Diode Reverse Recovery Charge	Q_{rr}		-	20	-	nC

Notes:

1. Repetitive Rating: Pulse width limited by maximum junction temperature.
2. Surface Mounted on FR4 Board, $t \leq 10$ sec.
3. Pulse Test: Pulse Width $\leq 300\mu s$, Duty Cycle $\leq 2\%$.
4. Guaranteed by design, not subject to product.



PE73100G P-Channel Enhancement Mode Power MOSFET

PE73100G Typical Electrical and Thermal Characteristics

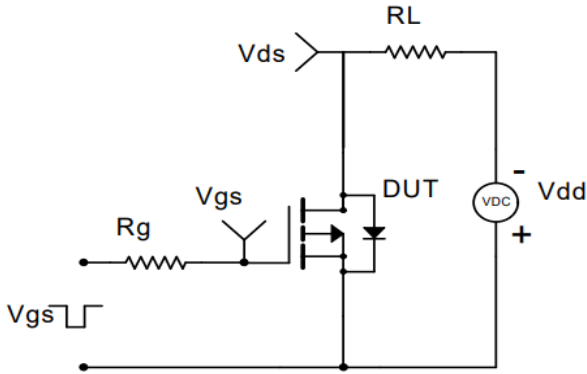

Figure 1 Switching Test Circuit

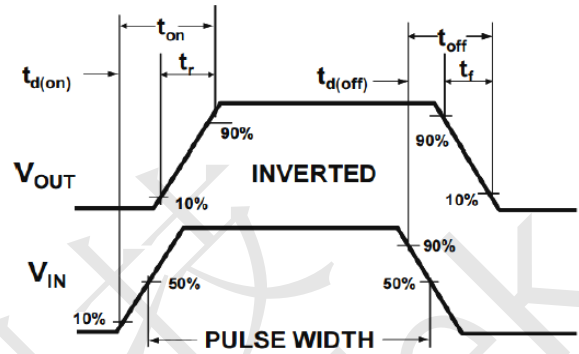

Figure 2 Switching Waveform

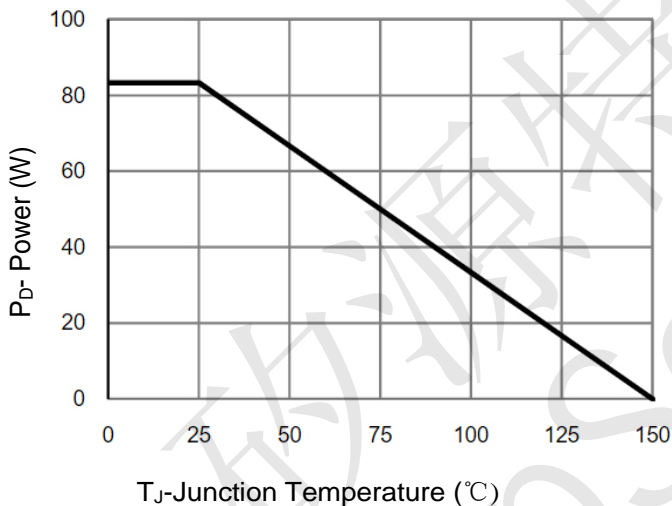

Figure 3 Power De-rating

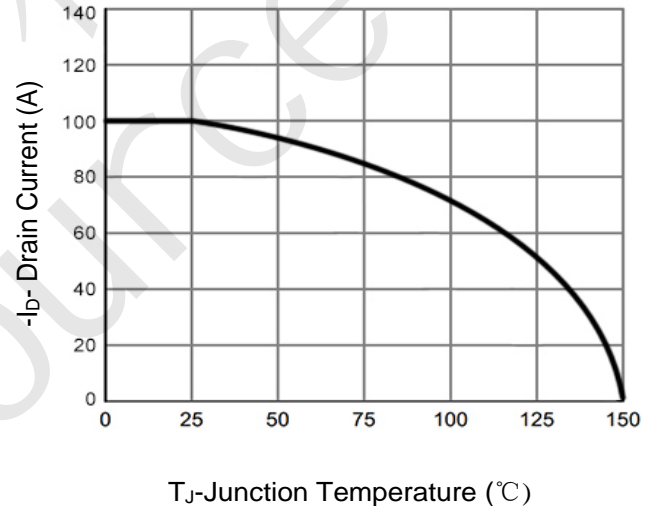

Figure 4 Drain Current

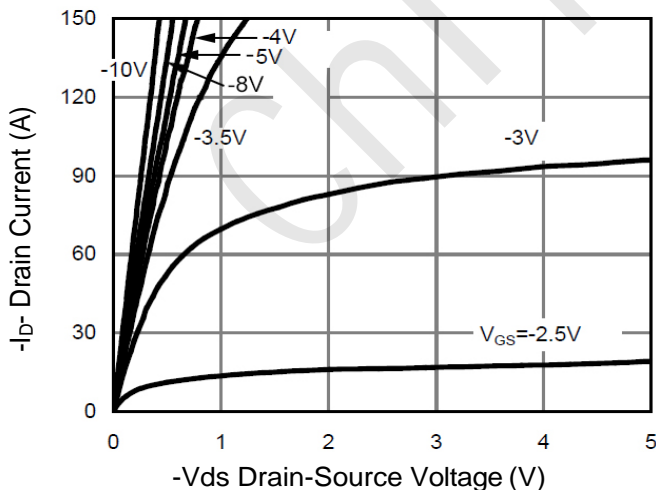

Figure 5 Output Characteristics

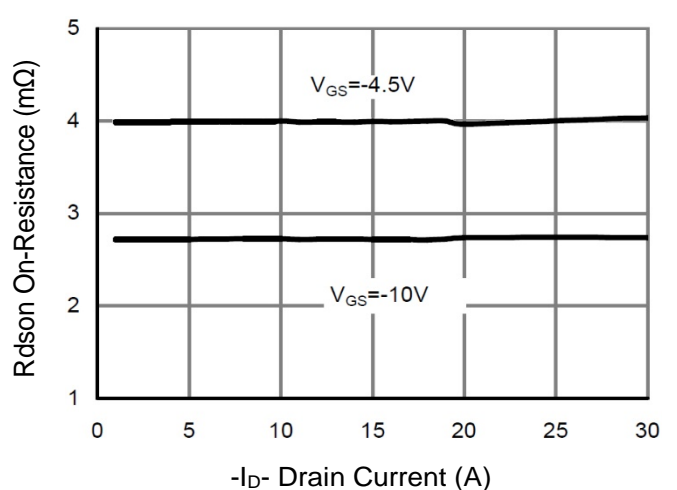

Figure 6 Rdson vs Drain Current



PE73100G P-Channel Enhancement Mode Power MOSFET

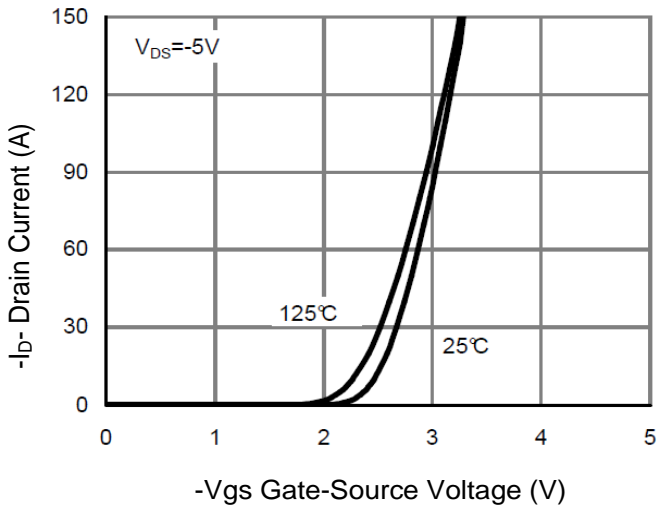

Figure 7 Transfer Characteristics

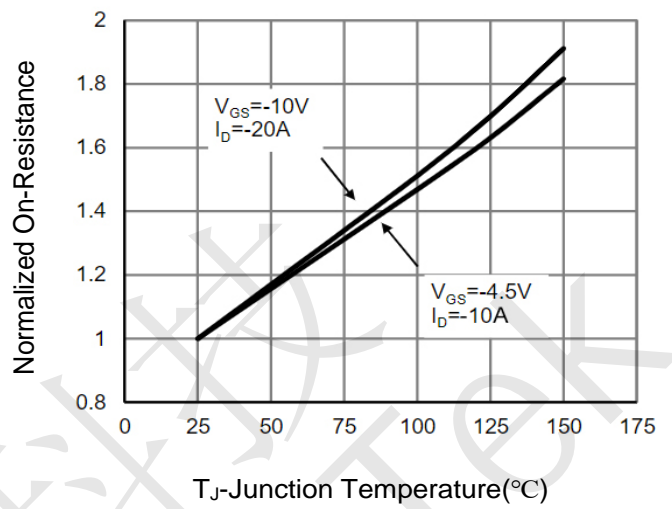

Figure 8 Rdson vs Junction Temperature

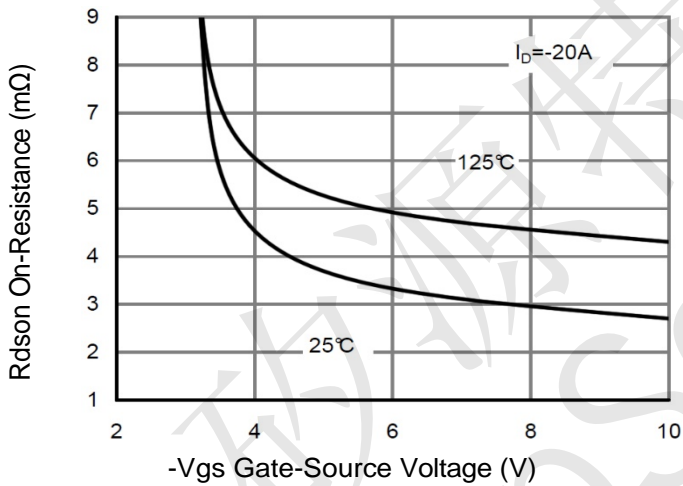

Figure 9 Rdson vs Vgs

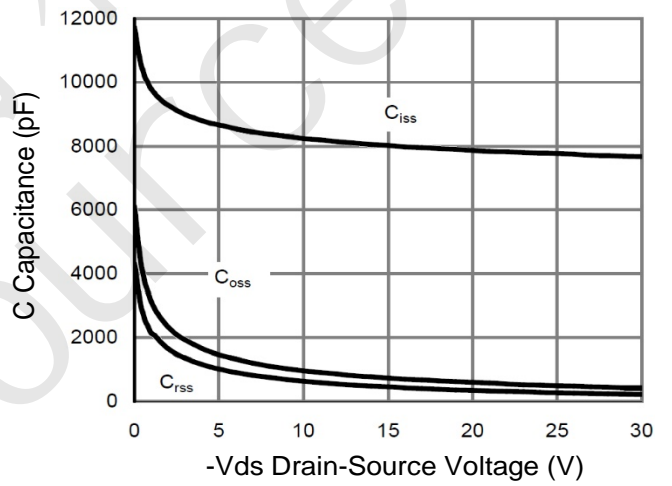

Figure 10 Capacitance vs Vds

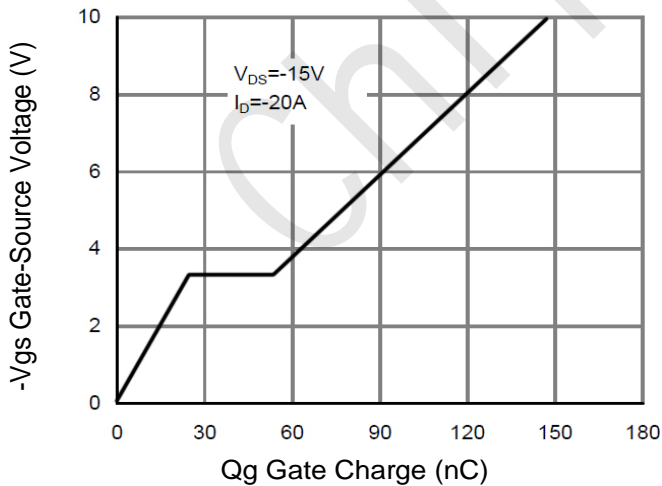

Figure 11 Gate Charge

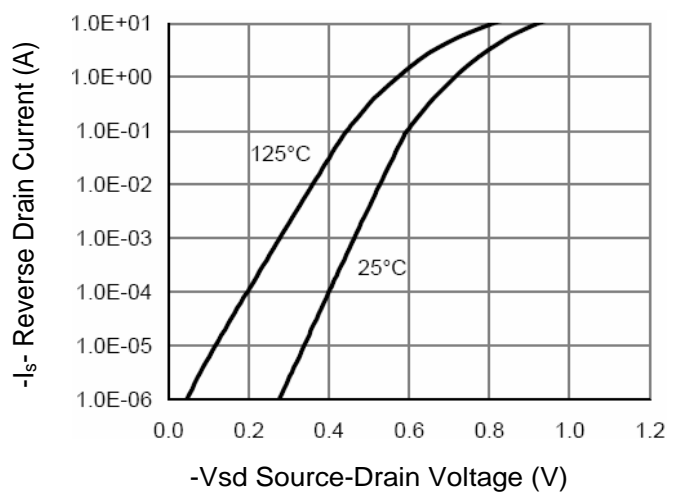

Figure 12 Source- Drain Diode Forward



PE73100G P-Channel Enhancement Mode Power MOSFET

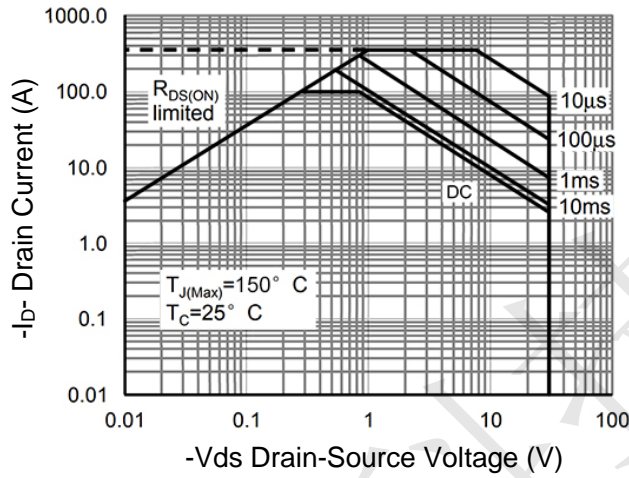

Figure 13 Safe Operation Area

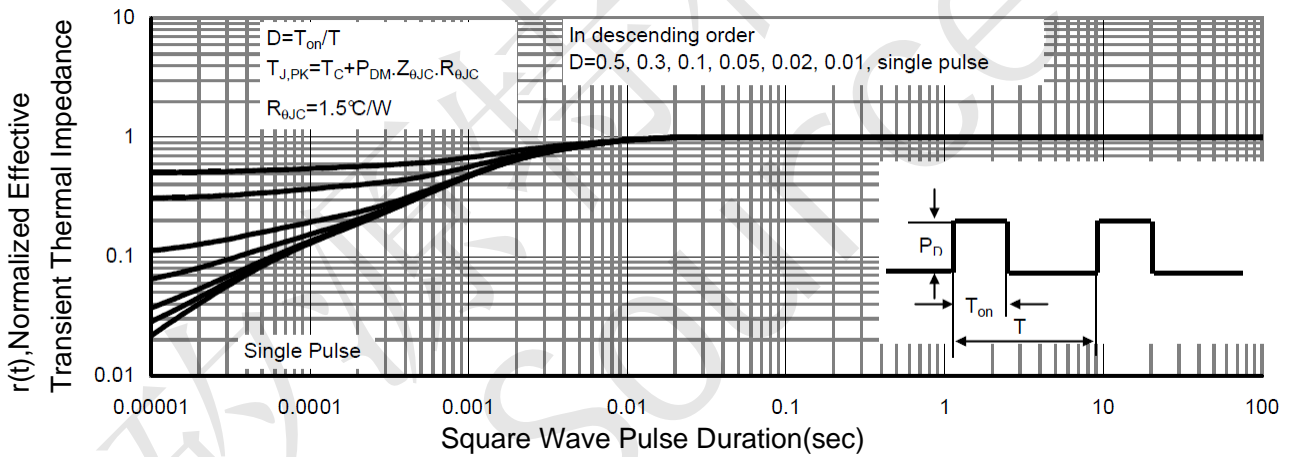
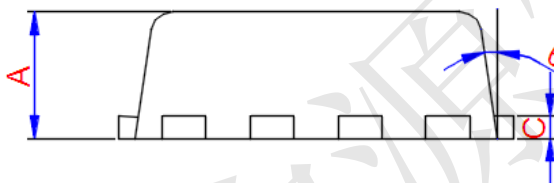
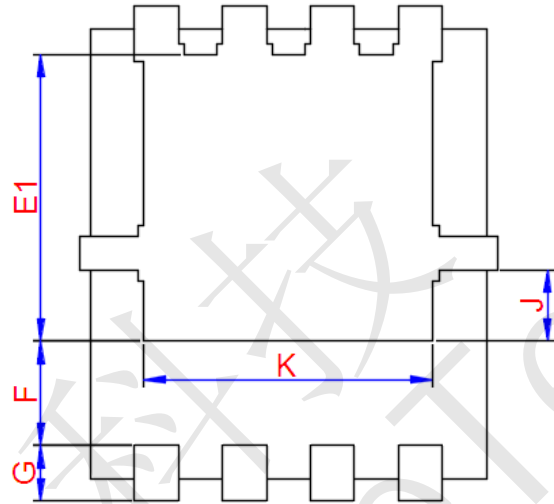
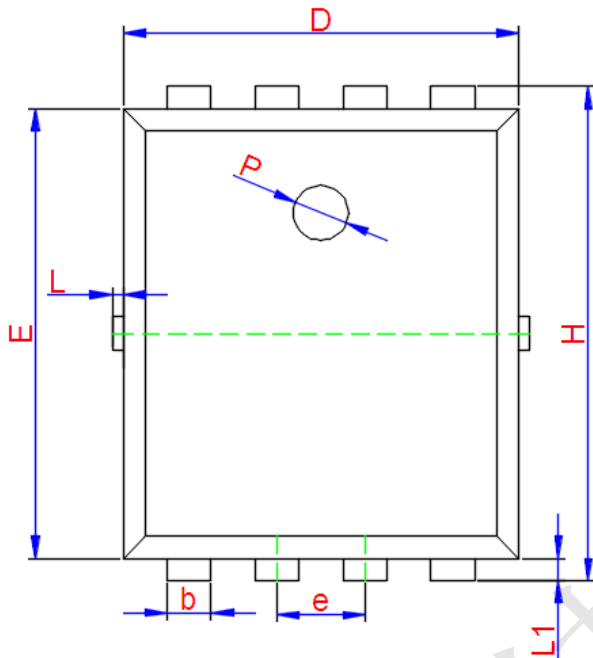

Figure 14 Normalized Maximum Transient Thermal Impedance



PE73100G P-Channel Enhancement Mode Power MOSFET

PE73100G DFN5x6-8L Package Information



Symbol	Dimensions In Millimeters		
	Min.	Typ.	Max.
A	0.800	0.900	1.000
b	0.350	0.420	0.490
c	0.254TYP.		
D	4.900	5.000	5.100
e	1.270TYP.		
E	5.700	5.800	5.900
E1	3.400TYP.		
F	1.400TYP.		
G	0.600TYP.		
H	5.950	6.080	6.200
J	0.950TYP.		
K	4.000TYP.		
L	-	-	0.150
L1	0.100	0.140	0.180
P	1.000TYP.		
θ	6°	10°	14°