



### PE7N65J N-Channel Enhancement Mode Power MOSFET

#### PE7N65J Description

The PE7N65J uses deep trench technology to provide excellent  $R_{DS(ON)}$  and low gate charge. It can be used in a wide variety of applications.

#### PE7N65J General Features

- $V_{DS} = 650V$ ,  $I_D = 7A$
- $R_{DS(ON)} < 1.4\Omega @ V_{GS}=10V$
- High Power and current handing capability
- Lead free product is acquired

#### PE7N65J Application

- PWM applications
- Load switch
- Power management

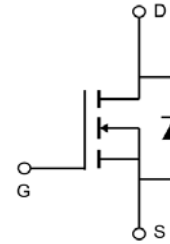

Schematic diagram

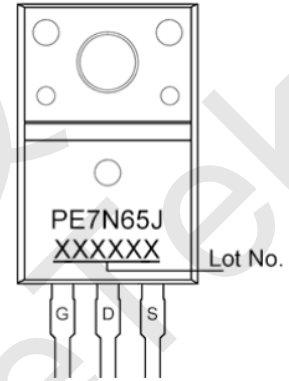

Marking and pin assignment



TO-220F

#### PE7N65J Absolute Maximum Ratings (TC=25°C unless otherwise noted)

Parameter	Symbol	Rating	Unit
Drain-Source Voltage	$V_{DS}$	650	V
Gate-Source Voltage	$V_{GS}$	$\pm 30$	V
Drain Current-Continuous	$I_D$	7	A
Drain Current-Continuous ( $T_C=100^\circ C$ )	$I_D(T_C=100^\circ C)$	4.4	A
Pulsed Drain Current (Note 1)	$I_{DM}$	28	A
Maximum Power Dissipation	$P_D$	32.9	W
Single Pulsed Avalanche Energy (L=0.5mH)	$E_{AS}$	247	mJ
Operating Junction and Storage Temperature Range	$T_J, T_{STG}$	-55 To 150	$^\circ C$

#### PE7N65J Thermal Characteristic

Thermal Resistance, Junction-to-Case	$R_{\theta JC}$	3.8	$^\circ C/W$
Thermal Resistance, Junction-to-Ambient (Note 2)	$R_{\theta JA}$	43.3	$^\circ C/W$



### PE7N65J Electrical Characteristics (TC=25°C unless otherwise noted)

Parameter	Symbol	Condition	Min	Typ	Max	Unit
<b>Off Characteristics</b>						
Drain-Source Breakdown Voltage	$BV_{DSS}$	$V_{GS}=0V, I_D=250\mu A$	650	-	-	V
Zero Gate Voltage Drain Current	$I_{DSS}$	$V_{DS}=650V, V_{GS}=0V$	-	-	1	$\mu A$
Gate-Body Leakage Current	$I_{GSS}$	$V_{GS}=\pm 30V, V_{DS}=0V$	-	-	$\pm 100$	nA
<b>On Characteristics</b> (Note 3)						
Gate Threshold Voltage	$V_{GS(th)}$	$V_{DS}=V_{GS}, I_D=250\mu A$	2	3	4	V
Drain-Source On-State Resistance	$R_{DS(ON)}$	$V_{GS}=10V, I_D=3.5A$	-	1.1	1.4	$\Omega$
Forward Transconductance	$g_{FS}$	$V_{DS}=40V, I_D=3.5A$	-	7.0	-	S
<b>Dynamic Characteristics</b> (Note 4)						
Input Capacitance	$C_{iss}$	$V_{DS}=25V, V_{GS}=0V,$ $F=1.0MHz$	-	800	-	pF
Output Capacitance	$C_{oss}$		-	101	-	pF
Reverse Transfer Capacitance (Note 4)	$C_{rss}$		-	1.5	-	pF
<b>Switching Characteristics</b>						
Turn-on Delay Time	$t_{d(on)}$	$V_{DS}=325V, I_D=7A,$ $V_{GS}=10V, R_G=25\Omega$	-	12	-	nS
Turn-on Rise Time	$t_r$		-	26	-	nS
Turn-Off Delay Time	$t_{d(off)}$		-	29	-	nS
Turn-Off Fall Time	$t_f$		-	27	-	nS
Total Gate Charge	$Q_g$	$V_{DS}=520V, I_D=7A,$ $V_{GS}=10V$	-	15.6	-	nC
Gate-Source Charge	$Q_{gs}$		-	4.8	-	nC
Gate-Drain Charge	$Q_{gd}$		-	4.1	-	nC
<b>Drain-Source Diode Characteristics</b>						
Diode Forward Voltage (Note 3)	$V_{SD}$	$V_{GS}=0V, I_S=7A$	-	0.9	1.2	V
Diode Forward Current	$I_S$		-	-	7	A
Body Diode Reverse Recovery Time	$t_{rr}$	$I_F=20A, di/dt=100A/\mu s$	-	389	-	ns
Body Diode Reverse Recovery Charge	$Q_{rr}$		-	2.04	-	$\mu C$

#### Notes:

1. Repetitive Rating: Pulse width limited by maximum junction temperature.
2. Surface Mounted on FR4 Board,  $t \leq 10$  sec.
3. Pulse Test: Pulse Width  $\leq 300\mu s$ , Duty Cycle  $\leq 2\%$ .
4. Guaranteed by design, not subject to product.



### PE7N65J Typical Electrical and Thermal Characteristics

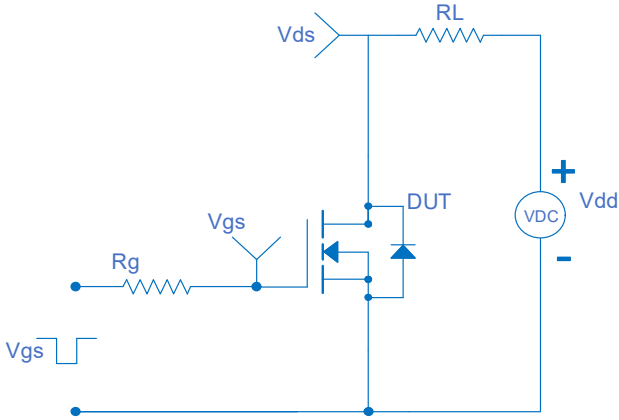

Figure 1 Switching Test Circuit

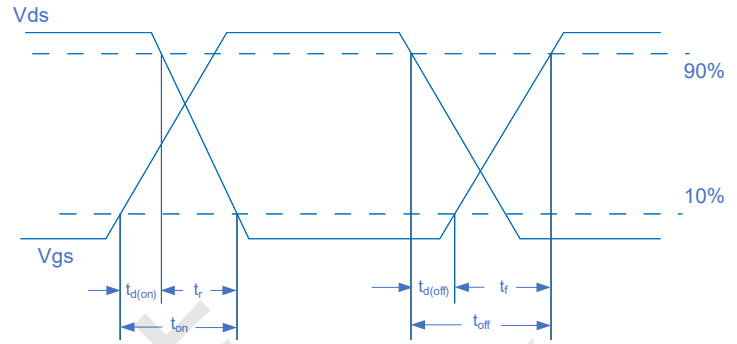

Figure 2 Switching Waveform

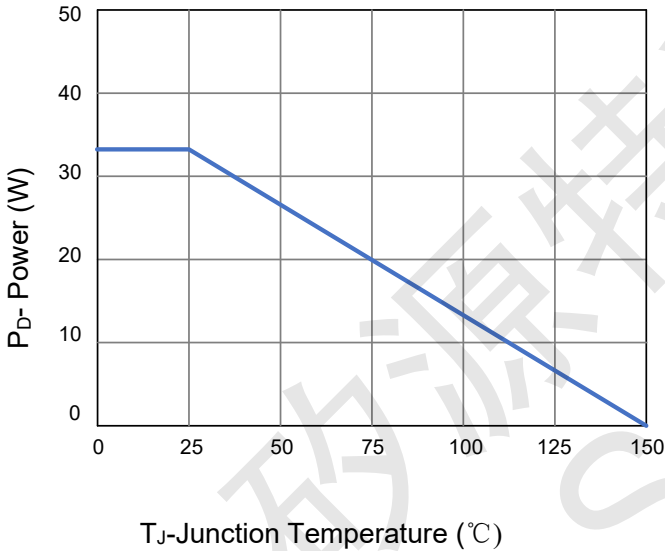

Figure 3 Power De-rating

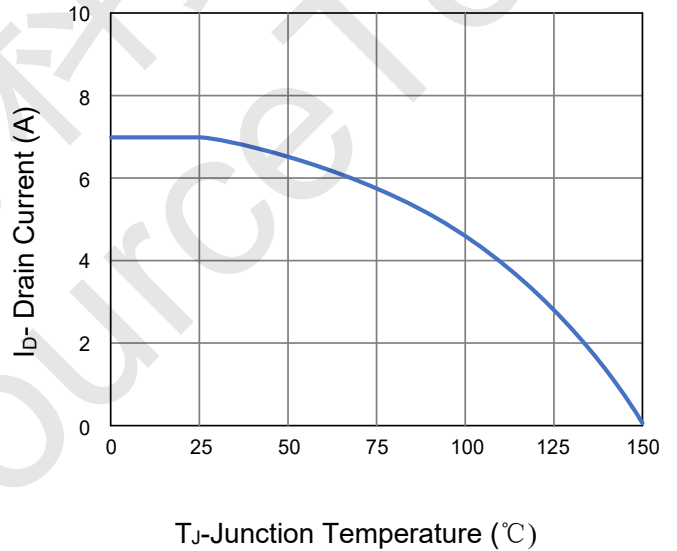

Figure 4 Drain Current

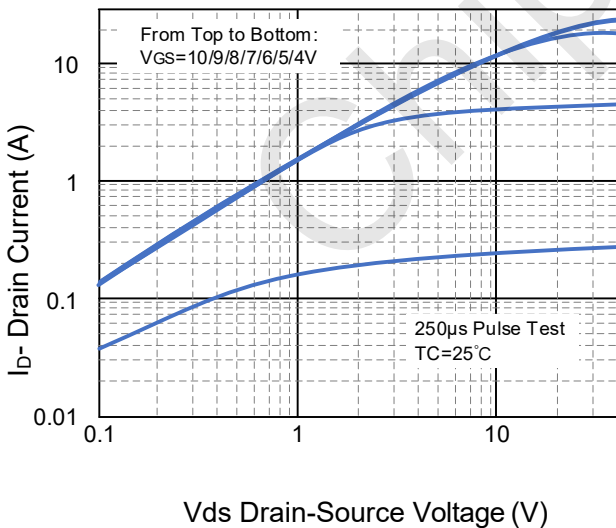

Figure 5 Output Characteristics

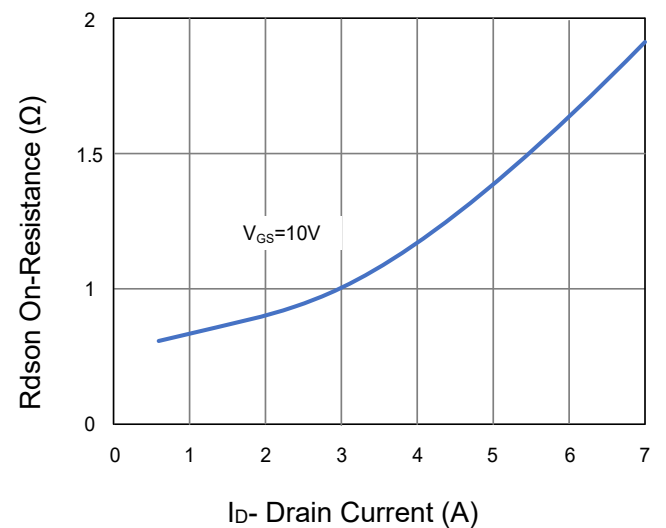
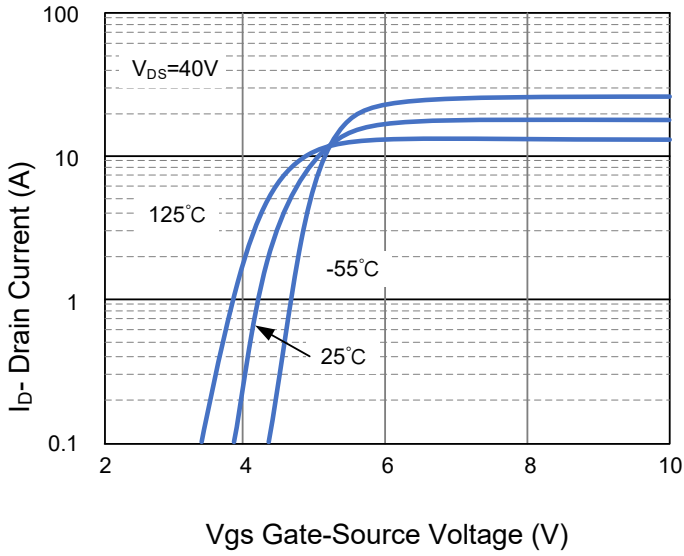
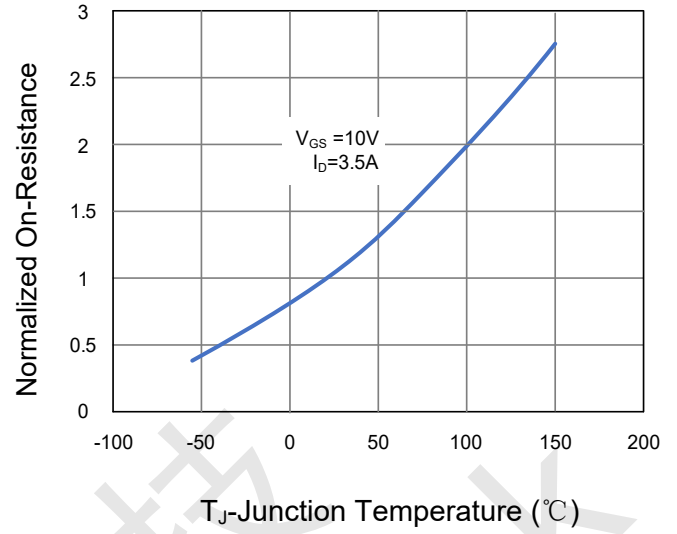

Figure 6 Rdson vs Drain Current



**Figure 7 Transfer Characteristics**



**Figure 8 Rdson vs Junction Temperature**

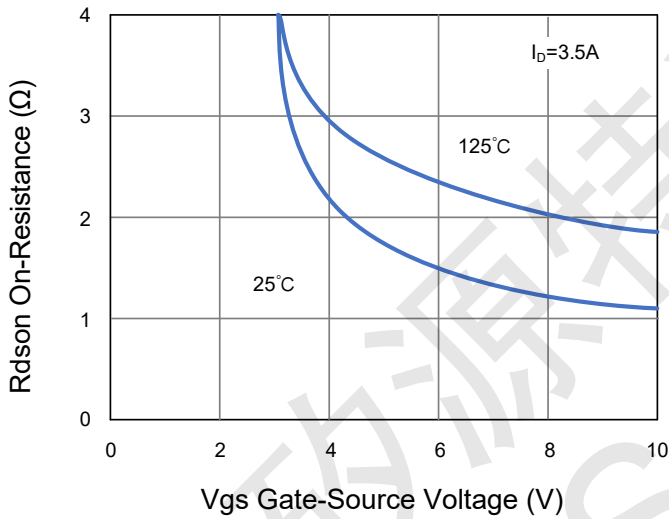

**Figure 9 Rdson vs Vgs**

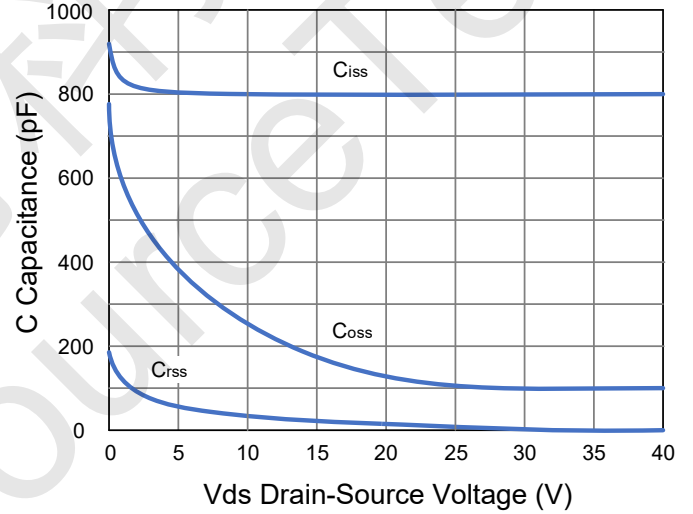

**Figure 10 Capacitance vs Vds**

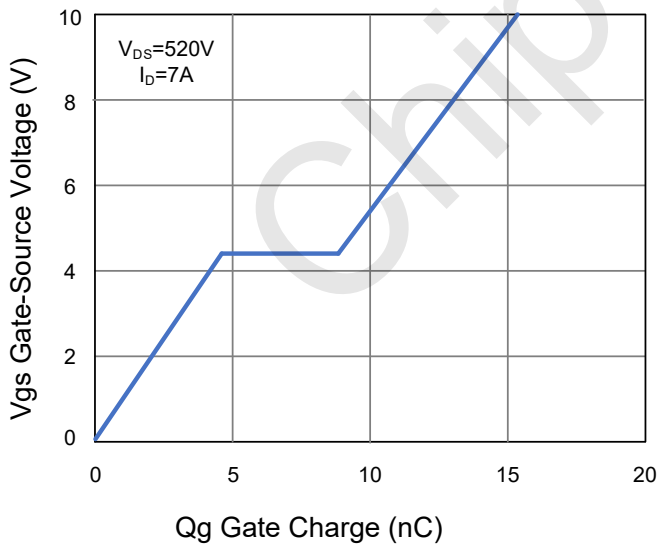

**Figure 11 Gate Charge**

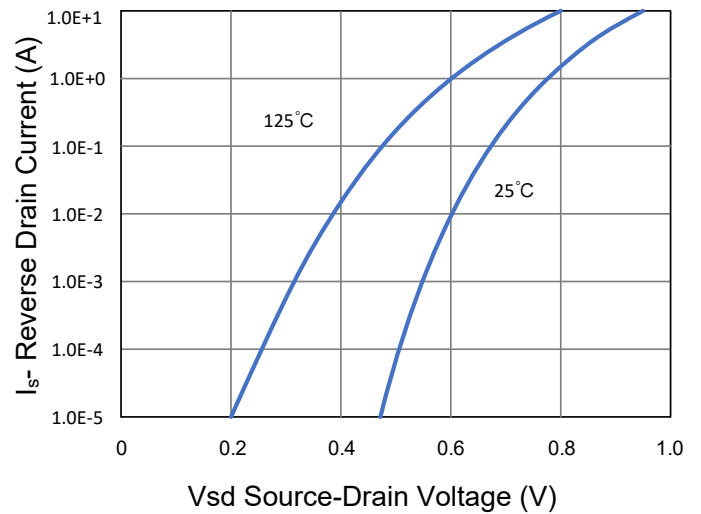

**Figure 12 Source- Drain Diode Forward**

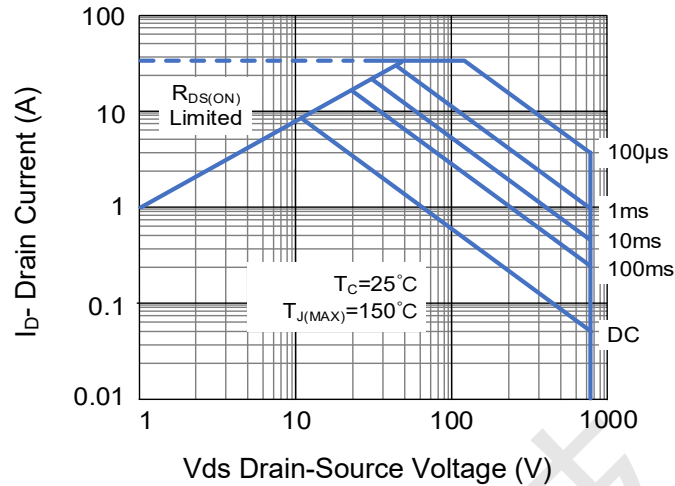

Figure 13 Safe Operation Area

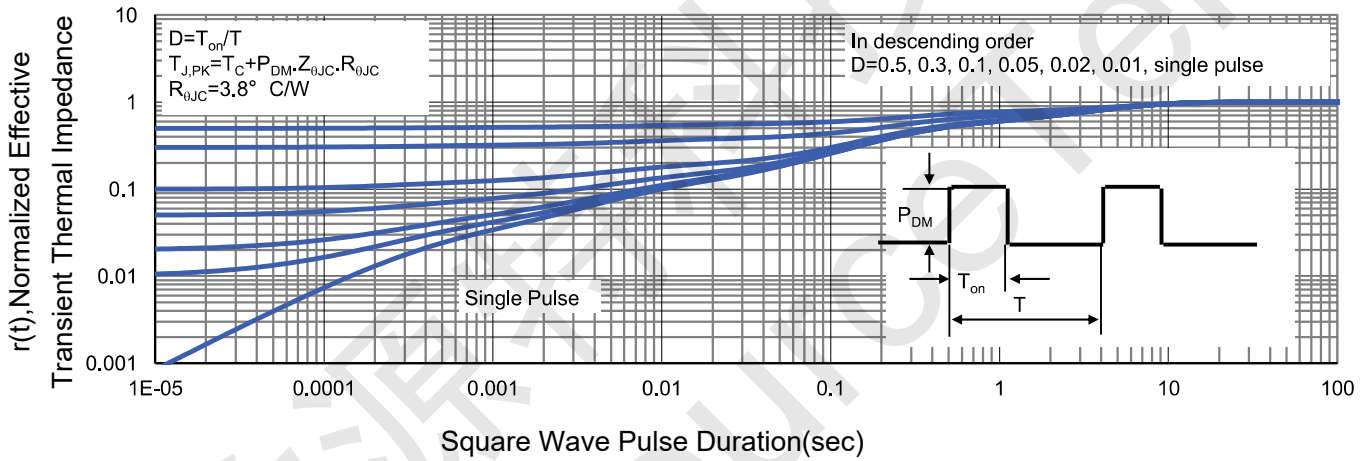
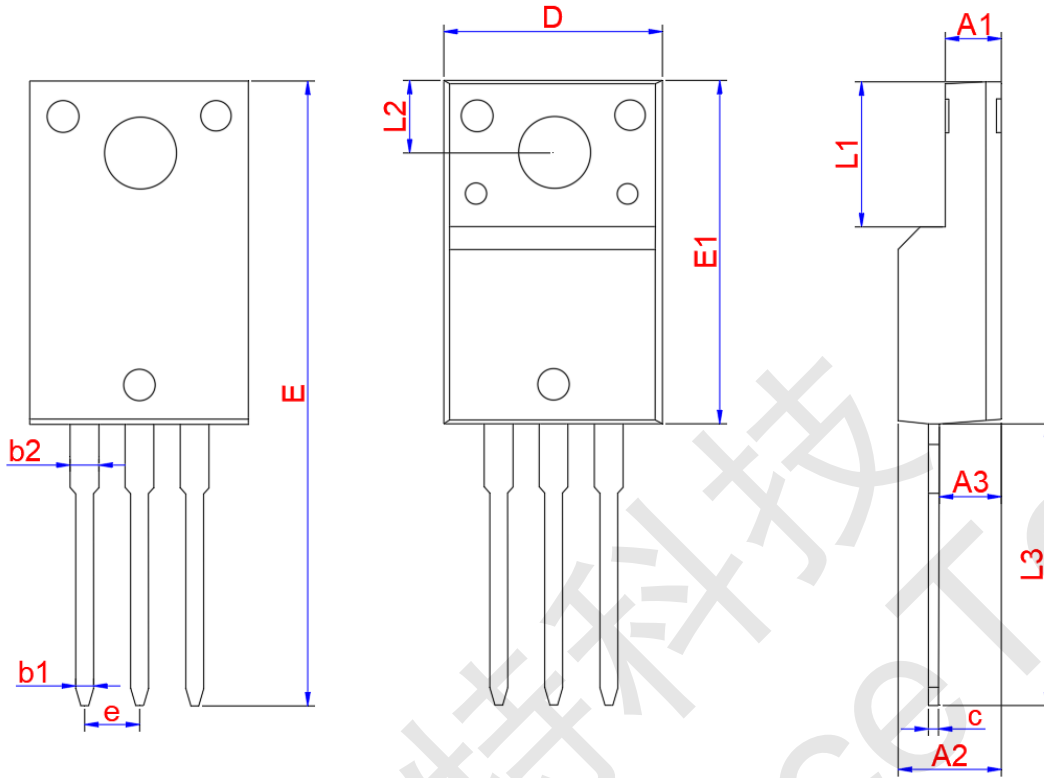

Figure 14 Normalized Maximum Transient Thermal Impedance



PE7N65J TO-220F Package Information



Symbol	Dimensions In Millimeters		
	Min.	Typ.	Max.
A1	2.440	2.540	2.640
A2	4.600	4.700	4.800
A3	2.730	2.830	2.930
b1	0.750	0.800	0.850
b2	1.230	1.280	1.330
c	0.450	0.500	0.550
D	10.060	10.160	10.260
E	28.650	28.850	29.050
E1	15.770	15.870	15.970
e	2.54 TYP.		
L1	6.68 REF		
L2	3.30 REF		
L3	12.830	12.980	13.130