



P-Channel Enhancement Mode Power MOSFET

**Description**

The PED2013M uses advanced trench technology to provide excellent  $R_{DS(ON)}$  and low gate charge. It can be used in a wide variety of applications.

**General Features**

- $V_{DS} = -20V, I_D = -40A$

$R_{DS(ON)} < 7m\Omega @ V_{GS} = -10V$

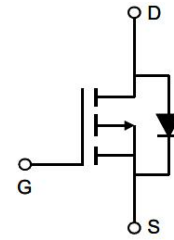
$R_{DS(ON)} < 8.5m\Omega @ V_{GS} = -4.5V$

$R_{DS(ON)} < 14m\Omega @ V_{GS} = -2.5V$

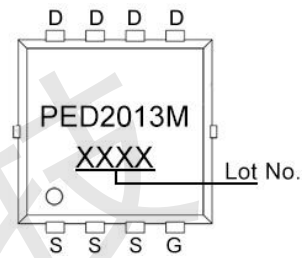
- High Power and current handling capability
- Lead free product is acquired
- Surface Mount Package

**Application**

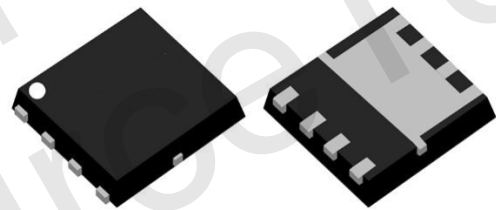
- PWM applications
- Load switch
- Power management



Schematic diagram



Marking and pin assignment



PDFN3.3x3.3-8L

**Absolute Maximum Ratings (TC=25°C unless otherwise noted)**

Parameter	Symbol	Rating	Unit
Drain-Source Voltage	$V_{DS}$	-20	V
Gate-Source Voltage	$V_{GS}$	$\pm 12$	V
Drain Current-Continuous (TC=25°C)	$I_D$	-40	A
Drain Current-Continuous (TC=100°C)	$I_D$	-29	A
Pulsed Drain Current (Note 1)	$I_{DM}$	-120	A
Maximum Power Dissipation	$P_D$	29	W
Avalanche Current	$I_{AS}$	40	A
Avalanche Energy (L=0.1mH)	$E_{AS}$	80	mJ
Operating Junction and Storage Temperature Range	$T_J, T_{STG}$	-55 To 150	°C

**Thermal Characteristic**

Thermal Resistance, Junction-to-Case	$R_{\theta JC}$	4.3	°C/W
--------------------------------------	-----------------	-----	------



**Electrical Characteristics (TC=25°C unless otherwise noted)**

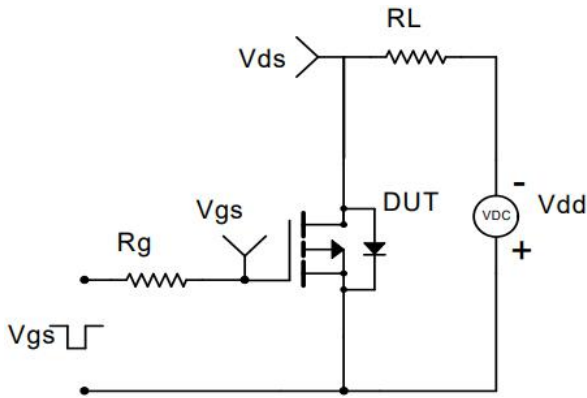
Parameter	Symbol	Condition	Min	Typ	Max	Unit
<b>Off Characteristics</b>						
Drain-Source Breakdown Voltage	$BV_{DSS}$	$V_{GS}=0V, I_D=-250\mu A$	-20	-	-	V
Zero Gate Voltage Drain Current	$I_{DSS}$	$V_{DS}=-20V, V_{GS}=0V$	-	-	-1	$\mu A$
Gate-Body Leakage Current	$I_{GSS}$	$V_{GS}=\pm 12V, V_{DS}=0V$	-	-	$\pm 100$	nA
<b>On Characteristics (Note 3)</b>						
Gate Threshold Voltage	$V_{GS(th)}$	$V_{DS}=V_{GS}, I_D=-250\mu A$	-0.45	-0.7	-1	V
Drain-Source On-State Resistance	$R_{DS(on)}$	$V_{GS}=-10V, I_D=-9A$	-	5.5	7	m $\Omega$
		$V_{GS}=-4.5V, I_D=-8A$	-	6.5	8.5	m $\Omega$
		$V_{GS}=-2.5V, I_D=-7A$	-	9	14	m $\Omega$
Forward Transconductance	$g_{FS}$	$V_{DS}=-5V, I_D=-10A$	-	95	-	S
<b>Dynamic Characteristics (Note 4)</b>						
Input Capacitance	$C_{iss}$	$V_{DS}=-10V, V_{GS}=0V,$ $F=1.0MHz$	-	4210	-	pF
Output Capacitance	$C_{oss}$		-	650	-	pF
Reverse Transfer Capacitance (Note 4)	$C_{rss}$		-	380	-	pF
<b>Switching Characteristics</b>						
Turn-on Delay Time	$t_{d(on)}$	$V_{DD}=-10V, R_L=1\Omega,$ $V_{GS}=-10V, R_G=3\Omega$	-	18	-	nS
Turn-on Rise Time	$t_r$		-	32	-	nS
Turn-Off Delay Time	$t_{d(off)}$		-	126	-	nS
Turn-Off Fall Time	$t_f$		-	59	-	nS
Total Gate Charge	$Q_g$	$V_{DS}=-10V, I_D=-14A,$ $V_{GS}=-4.5V$	-	44	-	nC
Gate-Source Charge	$Q_{gs}$		-	9	-	nC
Gate-Drain Charge	$Q_{gd}$		-	11	-	nC
<b>Drain-Source Diode Characteristics</b>						
Diode Forward Voltage (Note 3)	$V_{SD}$	$V_{GS}=0V, I_S=-1A$	-	-	-1.2	V
Diode Forward Current (Note 2)	$I_S$		-	-	-15	A

**Notes:**

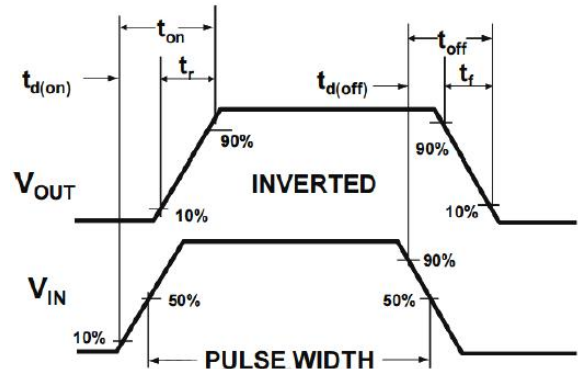
1. Repetitive Rating: Pulse width limited by maximum junction temperature.
2. Surface Mounted on FR4 Board,  $t \leq 10$  sec.
3. Pulse Test: Pulse Width  $\leq 300\mu s$ , Duty Cycle  $\leq 2\%$ .
4. Guaranteed by design, not subject to product.



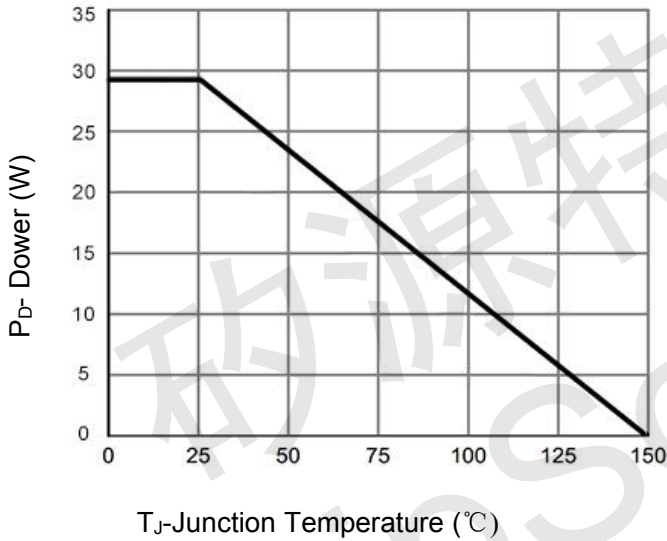
**Typical Electrical and Thermal Characteristics**



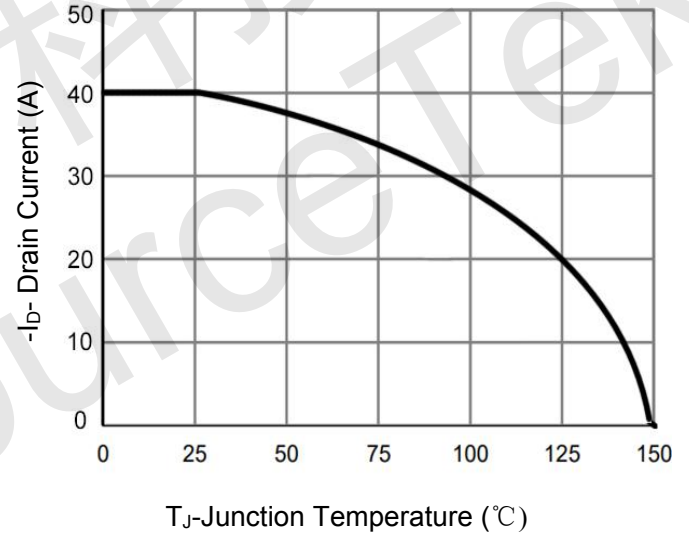
**Figure 1 Switching Test Circuit**



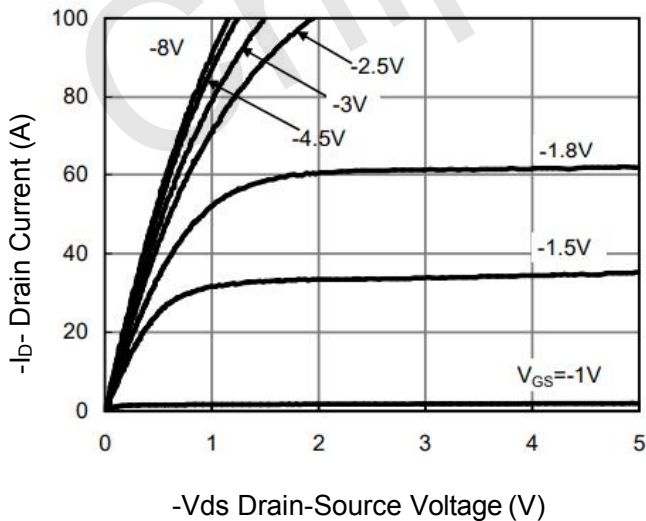
**Figure 2 Switching Waveform**



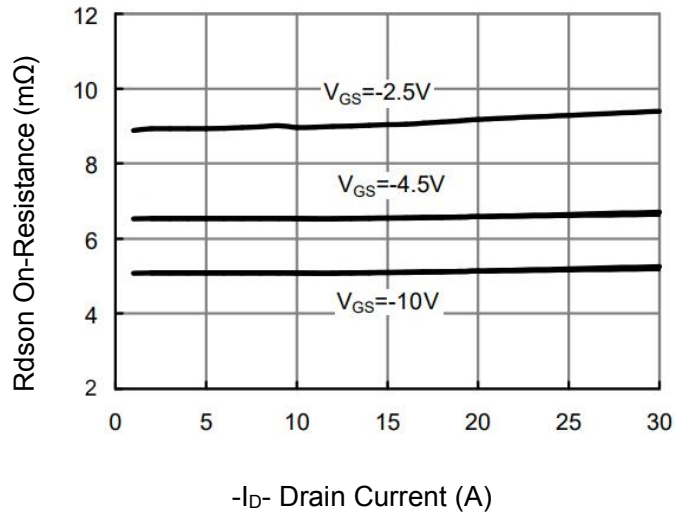
**Figure 3 Power De-rating**



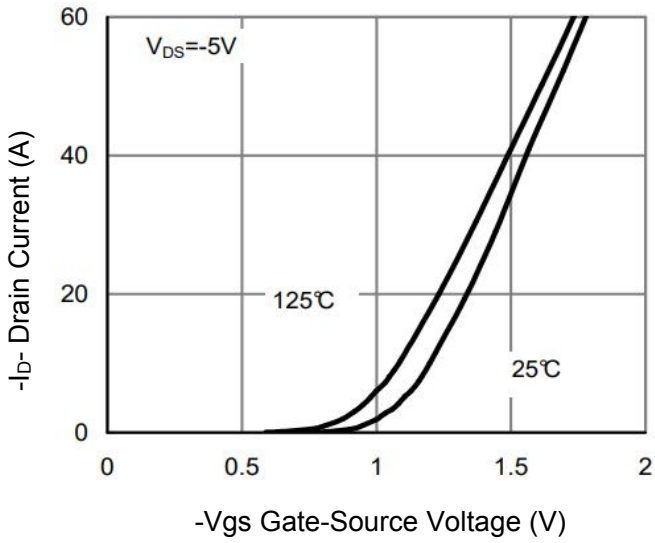
**Figure 4 Drain Current**



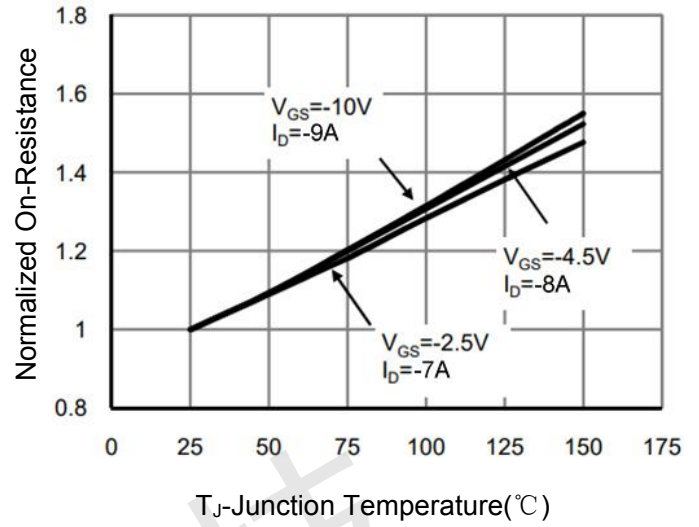
**Figure 5 Output Characteristics**



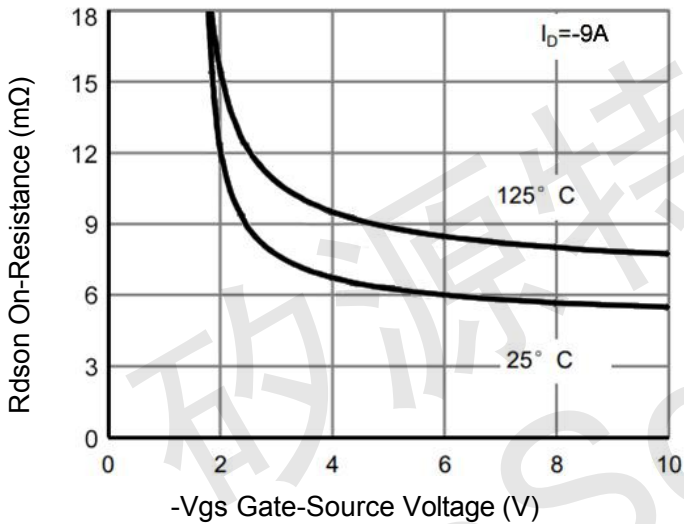
**Figure 6 R<sub>dson</sub> vs Drain Current**



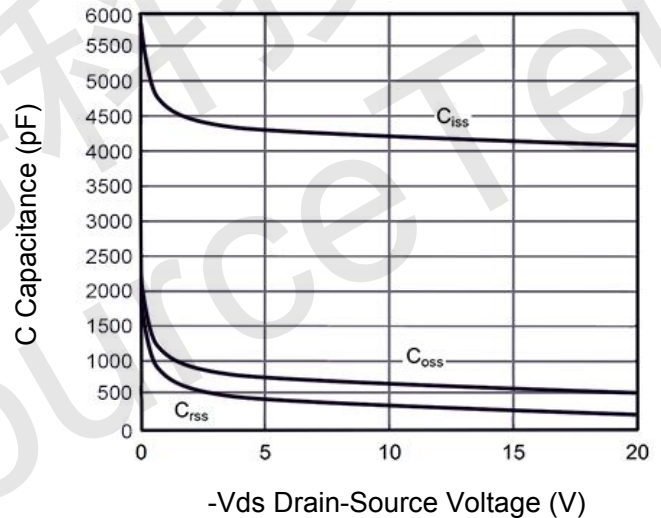
**Figure 7 Transfer Characteristics**



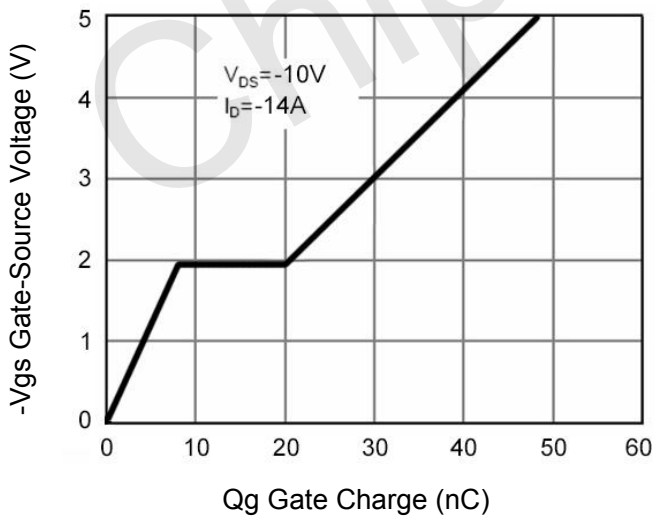
**Figure 8 Rdson vs Junction Temperature**



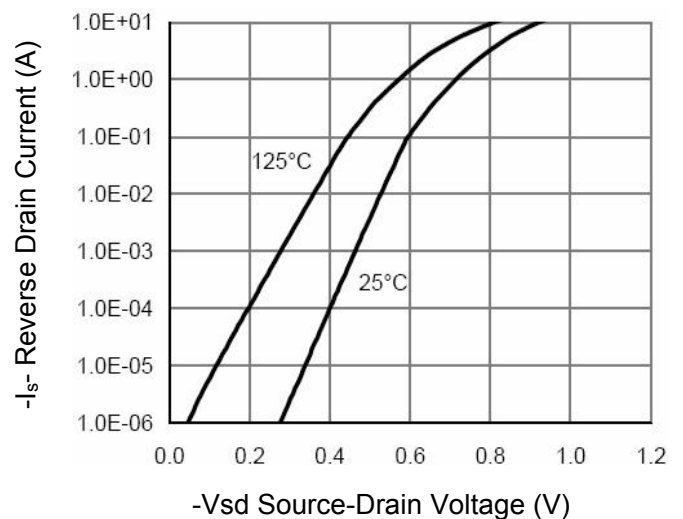
**Figure 9 Rdson vs Vgs**



**Figure 10 Capacitance vs Vds**

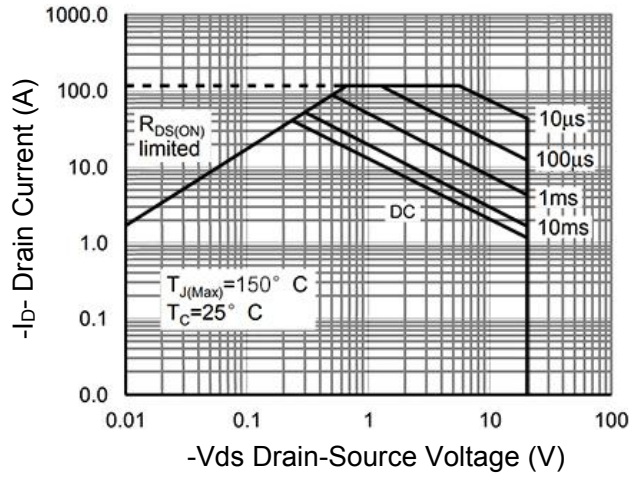


**Figure 11 Gate Charge**

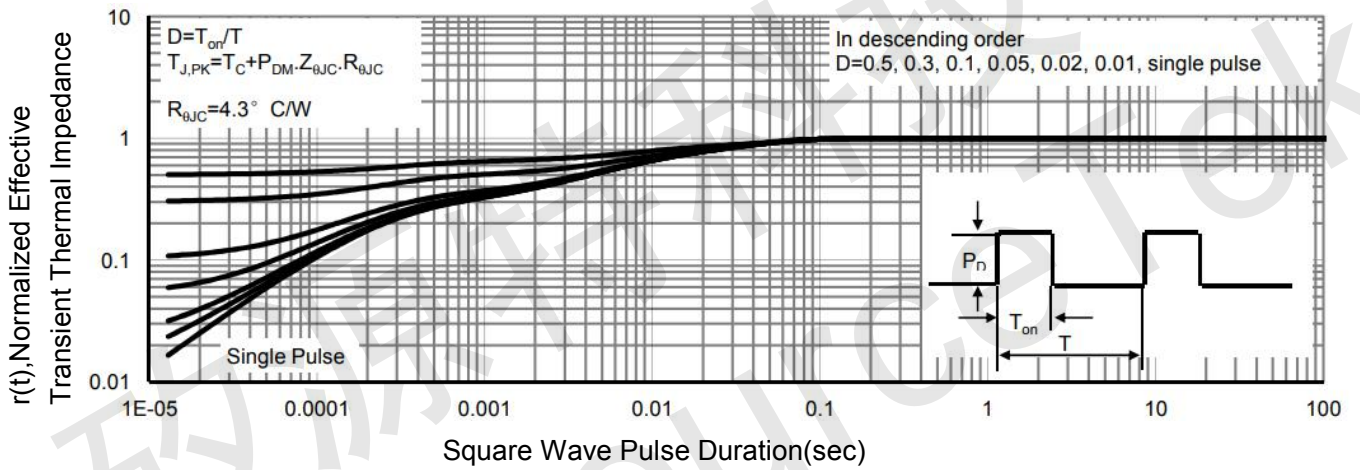


**Figure 12 Source- Drain Diode Forward**





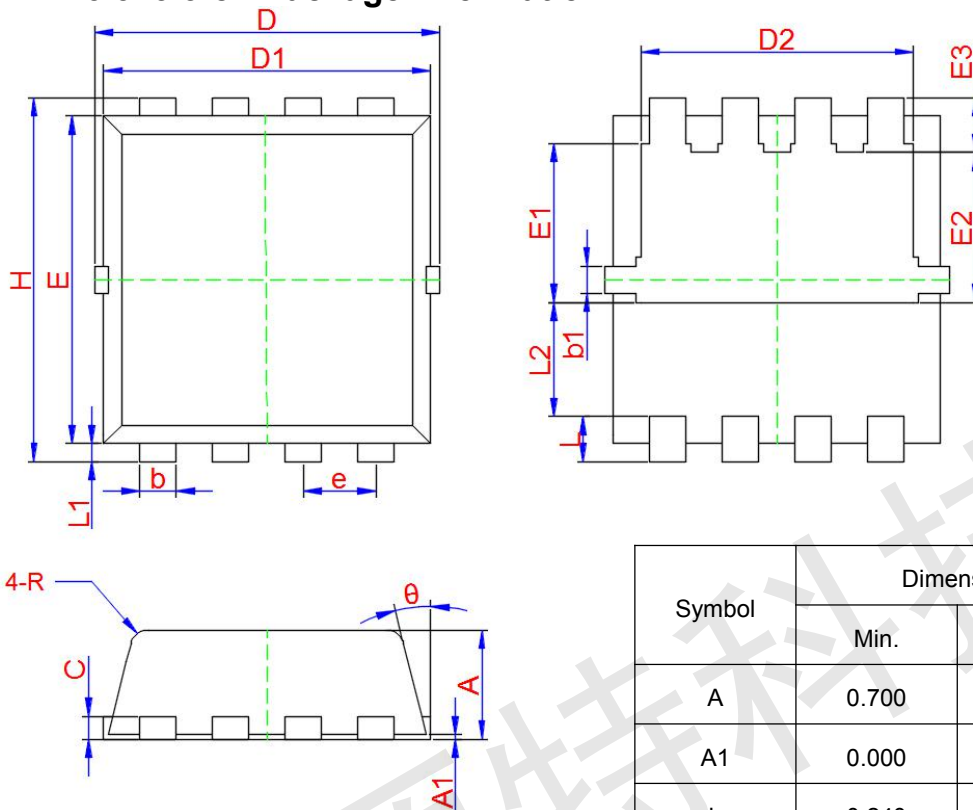
**Figure 13 Safe Operation Area**



**Figure 14 Normalized Maximum Transient Thermal Impedance**



**PDFN3.3x3.3-8L Package Information**



Symbol	Dimensions In Millimeters		
	Min.	Typ.	Max.
A	0.700	0.800	0.900
A1	0.000	0.030	0.050
b	0.240	0.300	0.350
b1	0.080	0.130	0.180
c	0.152 TYP.		
D	3.250	3.320	3.400
D1	3.050	3.150	3.250
D2	2.400	2.500	2.600
E	3.000	3.100	3.200
E1	1.350	1.450	1.550
E2	1.200	1.300	1.400
E3	0.400	0.500	0.600
e	0.650 TYP.		
H	3.200	3.300	3.400
L	0.300	0.400	0.500
L1	0.100	0.150	0.200
L2	1.130 TYP.		
R	0.200 TYP.		
θ	6°	10°	14°