



N-Channel Enhancement Mode Power MOSFET

PED30D12MT Description

The PED30D12MT uses advanced trench technology to provide excellent $R_{DS(ON)}$ and low gate charge. It can be used in a wide variety of applications.

PED30D12MT General Features

- $V_{DS} = 30V, I_D = 12A$
- $R_{DS(ON)} < 13m\Omega @ V_{GS}=10V$
- $R_{DS(ON)} < 19m\Omega @ V_{GS}=4.5V$
- High Power and current handling capability
- Lead free product is acquired
- Surface Mount Package

PED30D12MT Application

- PWM applications
- Load switch
- Power management

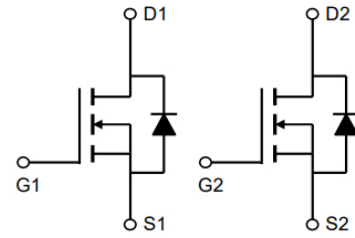

Schematic diagram

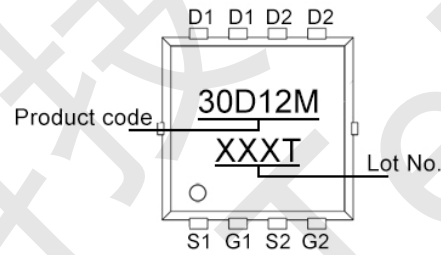

Marking and pin assignment

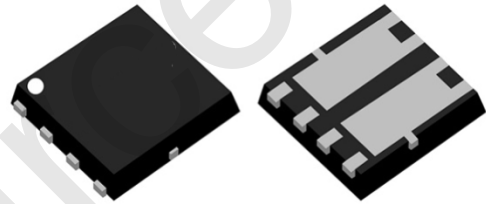

PDFN3.3x3.3-8L

PED30D12MT Absolute Maximum Ratings (TC=25°C unless otherwise noted)

Parameter	Symbol	Rating	Unit
Drain-Source Voltage	V_{DS}	30	V
Gate-Source Voltage	V_{GS}	± 20	V
Drain Current-Continuous	I_D	12	A
Drain Current-Continuous (TC=70°C)	I_D	9	A
Pulsed Drain Current (Note 1)	I_{DM}	48	A
Single Pulsed Avalanche Energy (L=0.1mH)	E_{AS}	24	mJ
Maximum Power Dissipation	P_D	20.8	W
Operating Junction and Storage Temperature Range	T_J, T_{STG}	-55 To 150	°C

PED30D12MT Thermal Characteristic

Thermal Resistance, Junction-to-Case	$R_{\theta JC}$	6	°C/W
--------------------------------------	-----------------	---	------



PED30D12MT Electrical Characteristics (TC=25°C unless otherwise noted)

Parameter	Symbol	Condition	Min	Typ	Max	Unit
Off Characteristics						
Drain-Source Breakdown Voltage	BV_{DSS}	$V_{GS}=0V, I_D=250\mu A$	30	-	-	V
Zero Gate Voltage Drain Current	I_{DSS}	$V_{DS}=30V, V_{GS}=0V$	-	-	1	μA
Gate-Body Leakage Current	I_{GSS}	$V_{GS}=\pm 20V, V_{DS}=0V$	-	-	± 100	nA
On Characteristics (Note 3)						
Gate Threshold Voltage	$V_{GS(th)}$	$V_{DS}=V_{GS}, I_D=250\mu A$	1.2	1.5	2.5	V
Drain-Source On-State Resistance	$R_{DS(ON)}$	$V_{GS}=10V, I_D=8A$	-	10.5	13	m Ω
		$V_{GS}=4.5V, I_D=4A$	-	14.5	19	m Ω
Dynamic Characteristics (Note 3)						
Input Capacitance	C_{iss}	$V_{DS}=15V, V_{GS}=0V,$ $F=1.0MHz$	-	545	-	pF
Output Capacitance	C_{oss}		-	90	-	pF
Reverse Transfer Capacitance (Note 4)	C_{rss}		-	70	-	pF
Switching Characteristics						
Turn-on Delay Time	$t_{d(on)}$	$V_{DD}=15V, R_L=1\Omega,$ $V_{GS}=10V, R_G=3\Omega$	-	4.5	-	nS
Turn-on Rise Time	t_r		-	7	-	nS
Turn-Off Delay Time	$t_{d(off)}$		-	27	-	nS
Turn-Off Fall Time	t_f		-	4	-	nS
Total Gate Charge	Q_g	$V_{DS}=15V, I_D=8A, V_{GS}=10V$	-	11	-	nC
Gate-Source Charge	Q_{gs}		-	2.4	-	nC
Gate-Drain Charge	Q_{gd}		-	3	-	nC
Drain-Source Diode Characteristics						
Diode Forward Voltage (Note 3)	V_{SD}	$V_{GS}=0V, I_S=1A$	-	-	1.2	V
Diode Forward Current (Note 2)	I_S		-	-	12	A
Diode Reverse Recovery Time	t_{rr}	$I_F=10A, di/dt=100A/\mu s$	-	18.6	-	nS
Diode Reverse Recovery Charge	Q_{rr}		-	6	-	nC

Notes:

1. Repetitive Rating: Pulse width limited by maximum junction temperature.
2. Surface Mounted on FR4 Board, $t \leq 10$ sec.
3. Pulse Test: Pulse Width $\leq 300\mu s$, Duty Cycle $\leq 2\%$.
4. Guaranteed by design, not subject to product.



PED30D12MT Typical Electrical and Thermal Characteristics

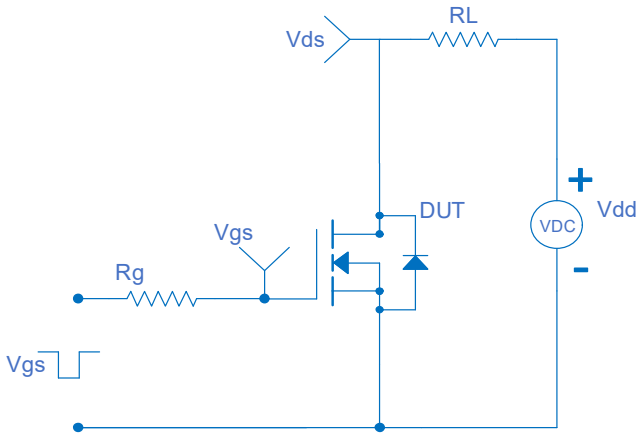

Figure 1 Switching Test Circuit

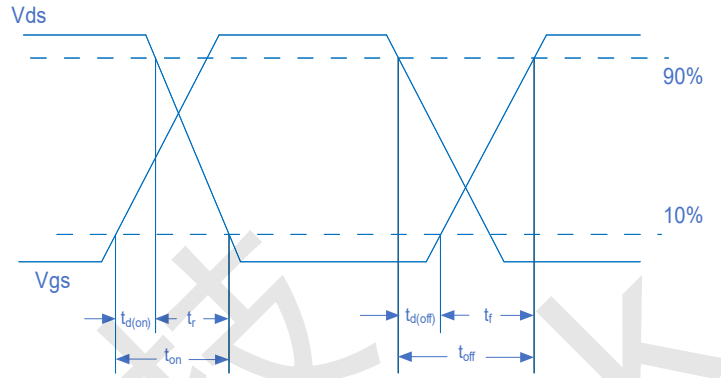

Figure 2 Switching Waveform

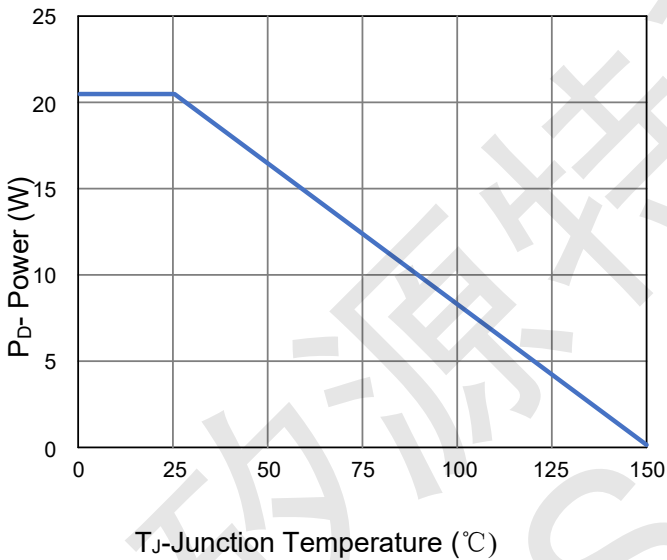

Figure 3 Power De-rating

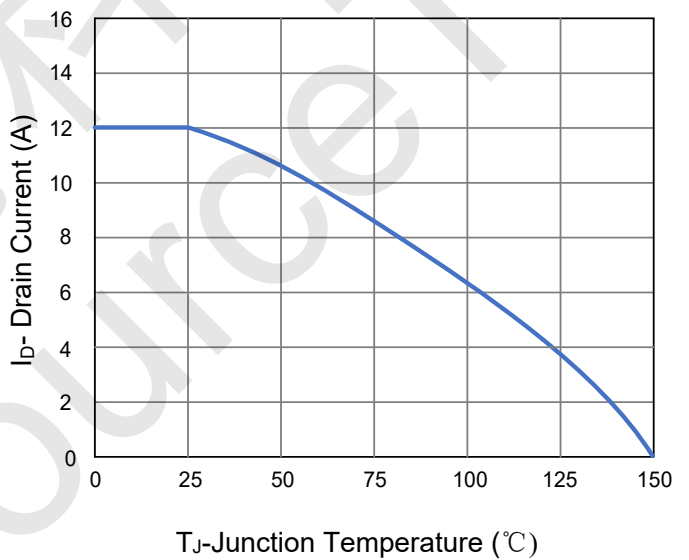

Figure 4 Drain Current

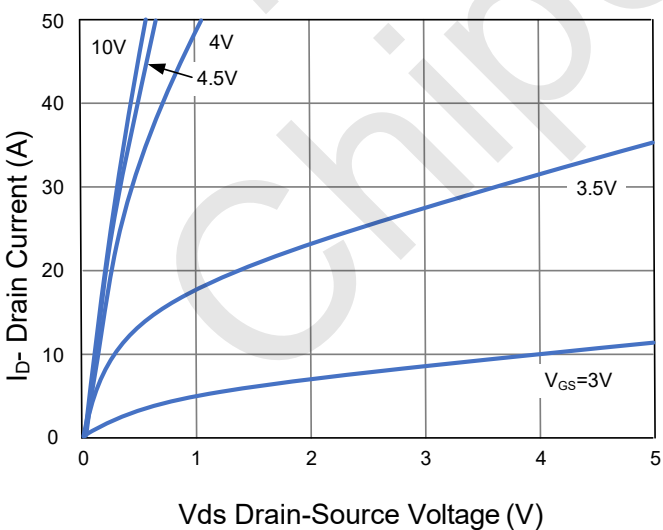

Figure 5 Output Characteristics

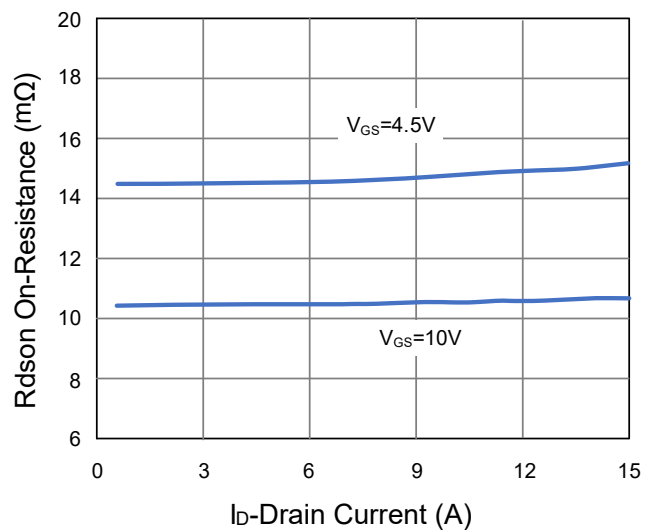

Figure 6 Rdson vs Drain Current

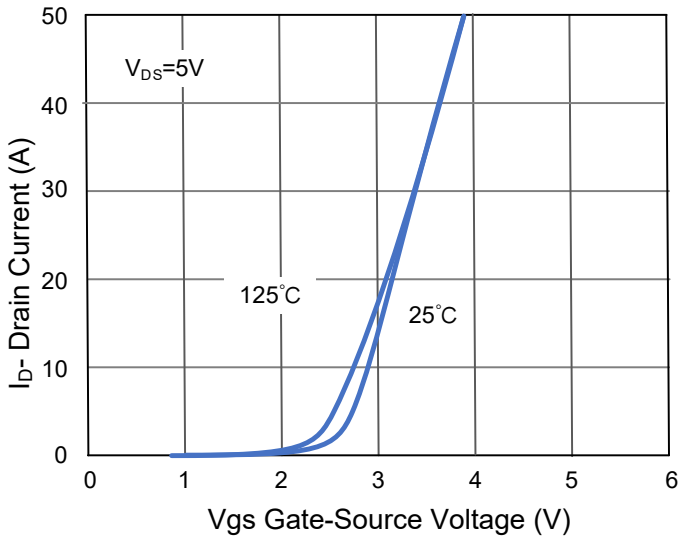

Figure 7 Transfer Characteristics

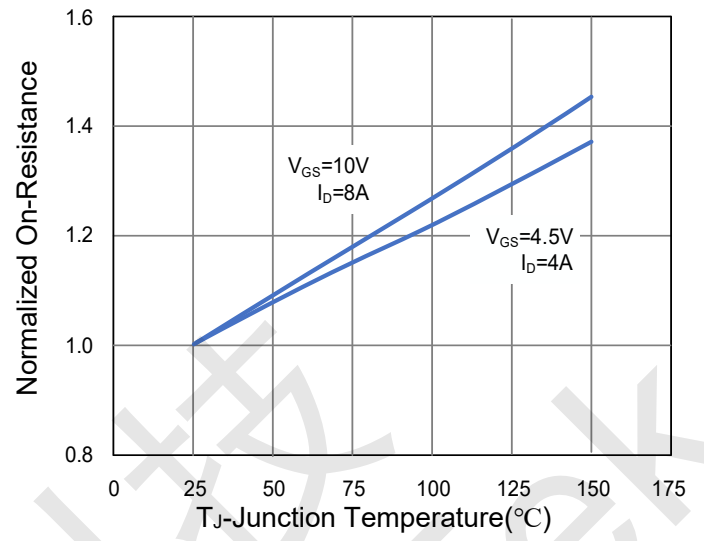

Figure 8 Rdson vs Junction Temperature

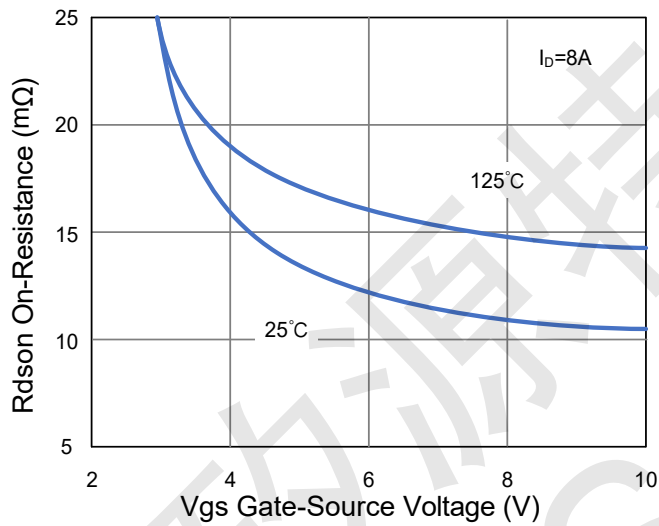

Figure 9 Rdson vs Vgs

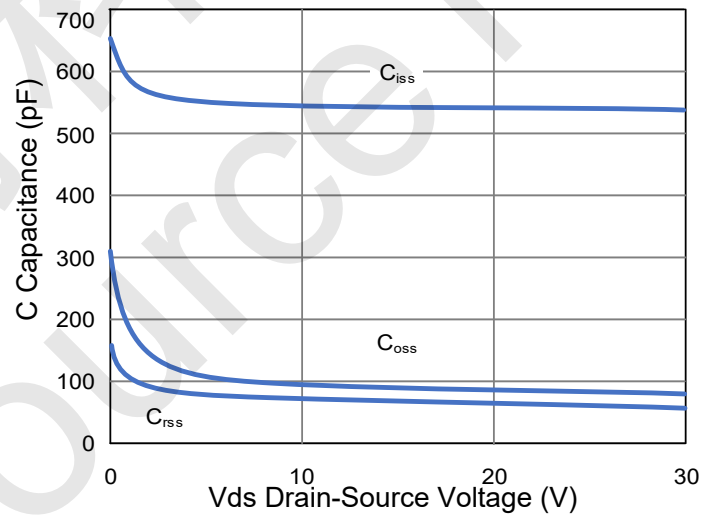

Figure 10 Capacitance vs Vds

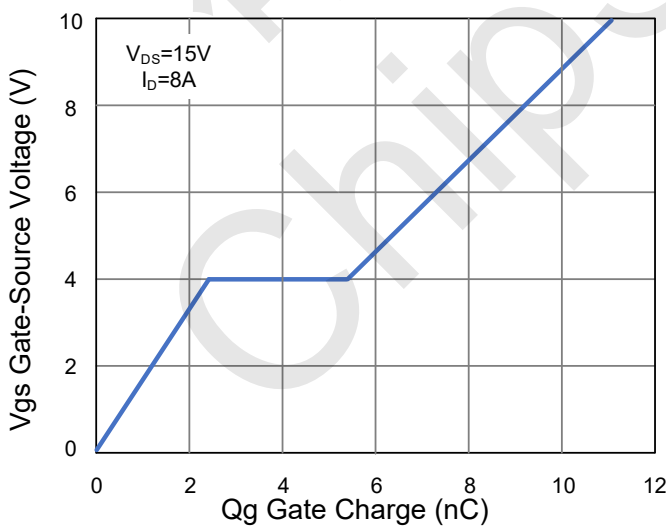

Figure 11 Gate Charge

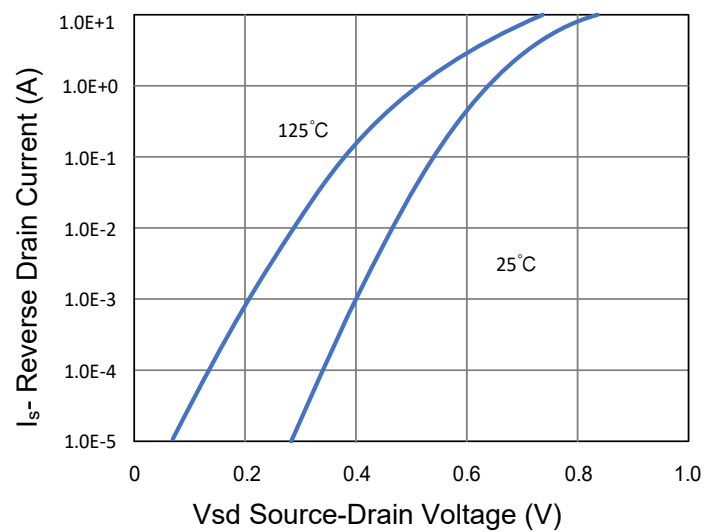

Figure 12 Source- Drain Diode Forward

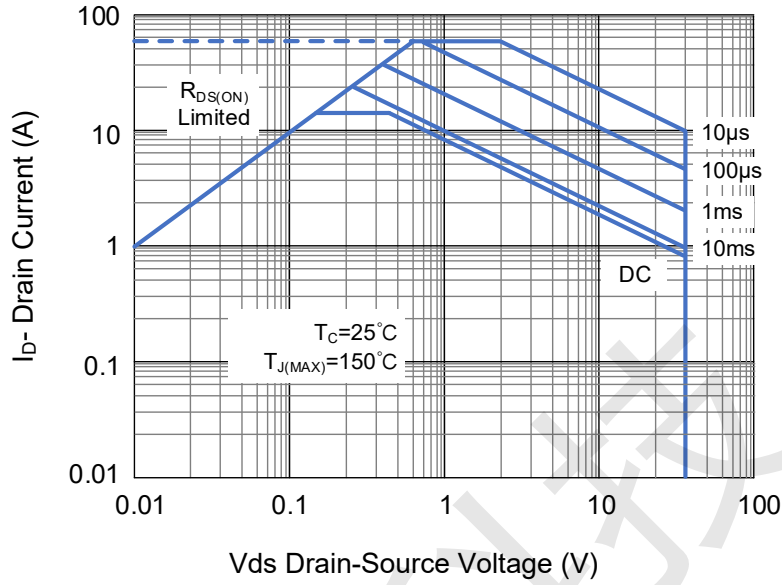

Figure 13 Safe Operation Area

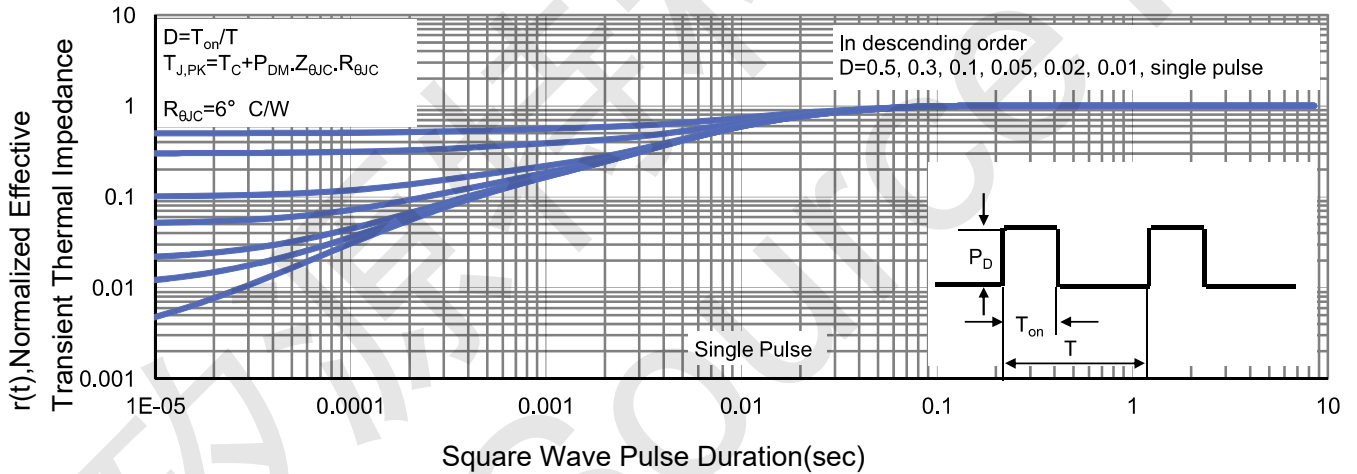
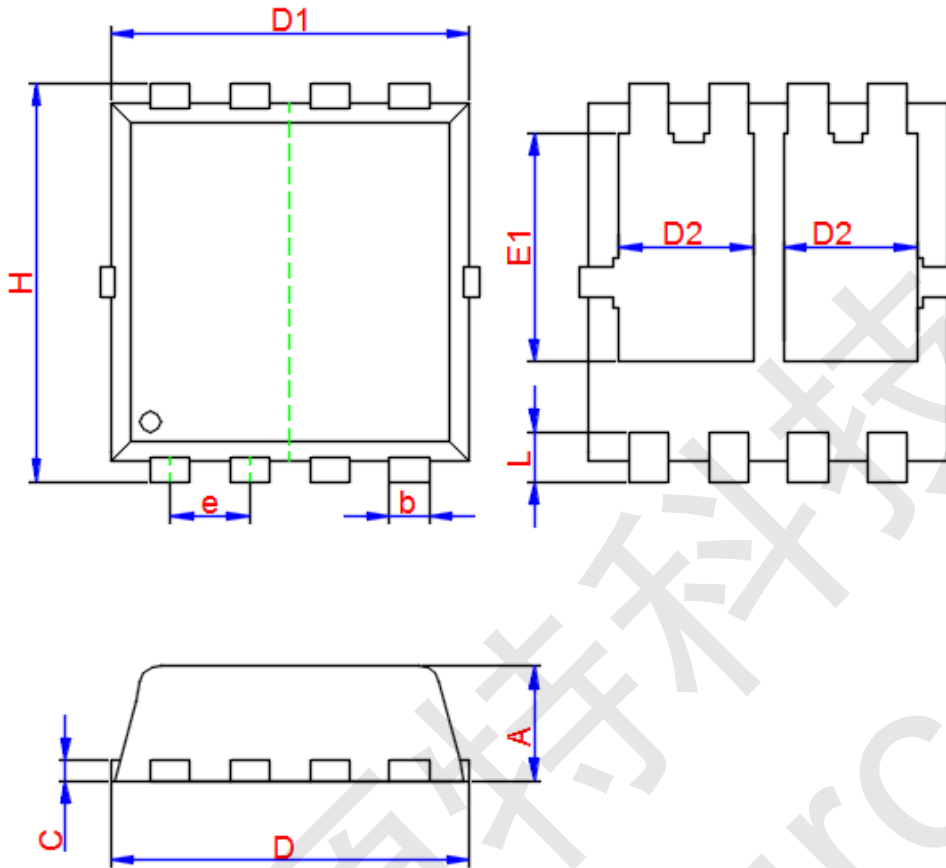

Figure 14 Normalized Maximum Transient Thermal Impedance



PED30D12MT PDFN3.3x3.3-8L Package Information



Symbol	Dimensions In Millimeters		
	Min.	Typ.	Max.
A	0.675	0.775	0.875
b	0.300TYP.		
C	0.152TYP.		
D	3.100	3.300	3.500
D1	3.050	3.150	3.250
D2	0.835	1.035	1.235
e	0.650TYP.		
E1	1.530	1.730	1.930
H	3.150	3.350	3.550
L	0.280	0.380	0.480