



## P-Channel Enhancement Mode Power MOSFET

### Description

The PED805 uses advanced trench technology to provide excellent  $R_{DS(ON)}$  and low gate charge. It can be used in a wide variety of applications.

### General Features

- $V_{DS} = -12V$ ,  $I_D = -8.5A$
- $R_{DS(ON)} < 18m\Omega @ V_{GS} = -4.5V$
- $R_{DS(ON)} < 25m\Omega @ V_{GS} = -2.5V$
- High Power and current handing capability
- Lead free product is acquired
- Surface Mount Package

### Application

- PWM applications
- Load switch
- Power management
- Battery Protection

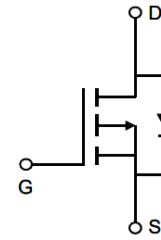

Schematic diagram

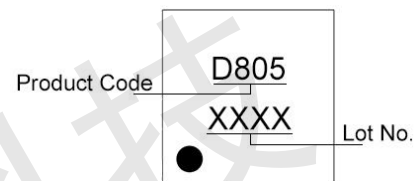

Marking

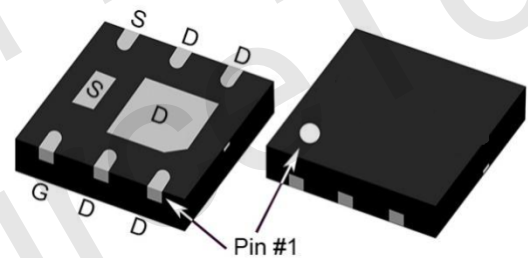

UDFN2x2-6L

### Absolute Maximum Ratings (TA=25°C unless otherwise noted)

Parameter	Symbol	Rating	Unit
Drain-Source Voltage	$V_{DS}$	-12	V
Gate-Source Voltage	$V_{GS}$	$\pm 12$	V
Drain Current-Continuous	$I_D$	-8.5	A
Pulsed Drain Current (Note 1)	$I_{DM}$	-32	A
Maximum Power Dissipation	$P_D$	2.8	W
Operating Junction and Storage Temperature Range	$T_J, T_{STG}$	-55 To 150	°C

### Thermal Characteristic

Thermal Resistance, Junction-to-Ambient (Note 2)	$R_{\theta JA}$	45	°C/W
--	-----------------	----	------



**Electrical Characteristics (TA=25°C unless otherwise noted)**

Parameter	Symbol	Condition	Min	Typ	Max	Unit
<b>Off Characteristics</b>						
Drain-Source Breakdown Voltage	$BV_{DSS}$	$V_{GS}=0V, I_D=-250\mu A$	-	-12	-	V
Zero Gate Voltage Drain Current	$I_{DSS}$	$V_{DS}=-12V, V_{GS}=0V$	-	-	-1	$\mu A$
Gate-Body Leakage Current	$I_{GSS}$	$V_{GS}=\pm 12V, V_{DS}=0V$	-	-	$\pm 100$	nA
<b>On Characteristics (Note 3)</b>						
Gate Threshold Voltage	$V_{GS(th)}$	$V_{DS}=V_{GS}, I_D=-250\mu A$	-0.4	-0.7	-1.2	V
Drain-Source On-State Resistance	$R_{DS(ON)}$	$V_{GS}=-4.5V, I_D=-6A$	-	14	18	m $\Omega$
		$V_{GS}=-2.5V, I_D=-5A$	-	19	25	m $\Omega$
Forward Transconductance	$g_{FS}$	$V_{DS}=-5V, I_D=-6A$	-	33	-	S
<b>Dynamic Characteristics (Note 4)</b>						
Input Capacitance	$C_{iss}$	$V_{DS}=-10V, V_{GS}=0V,$ $F=1.0MHz$	-	1770	-	pF
Output Capacitance	$C_{oss}$		-	410	-	pF
Reverse Transfer Capacitance (Note 4)	$C_{rss}$		-	390	-	pF
<b>Switching Characteristics</b>						
Turn-on Delay Time	$t_{d(on)}$	$V_{DD}=-10V, R_L=1\Omega,$ $V_{GS}=-4.5V, R_G=3\Omega$	-	11	-	nS
Turn-on Rise Time	$t_r$		-	25	-	nS
Turn-Off Delay Time	$t_{d(off)}$		-	70	-	nS
Turn-Off Fall Time	$t_f$		-	42	-	nS
Total Gate Charge	$Q_g$	$V_{DS}=-10V, I_D=-6A,$ $V_{GS}=-4.5V$	-	15	-	nC
Gate-Source Charge	$Q_{gs}$		-	4	-	nC
Gate-Drain Charge	$Q_{gd}$		-	7	-	nC
<b>Drain-Source Diode Characteristics</b>						
Diode Forward Voltage (Note 3)	$V_{SD}$	$V_{GS}=0V, I_S=-1A$	-	-	-1.2	V
Diode Forward Current (Note 2)	$I_S$		-	-	-3.5	A

**Notes:**

1. Repetitive Rating: Pulse width limited by maximum junction temperature.
2. Surface Mounted on FR4 Board,  $t \leq 10$  sec.
3. Pulse Test: Pulse Width  $\leq 300\mu s$ , Duty Cycle  $\leq 2\%$ .
4. Guaranteed by design, not subject to product.



**Typical Electrical and Thermal Characteristics**

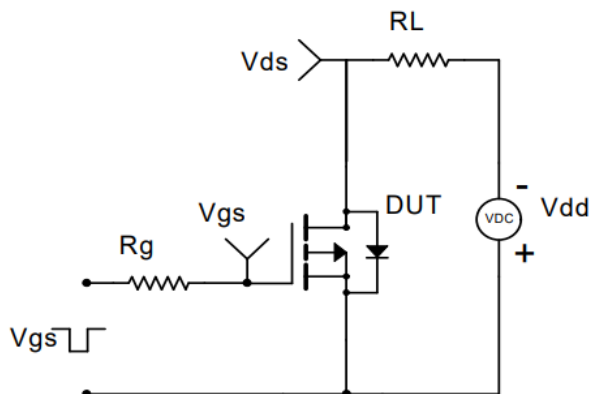

**Figure 1 Switching Test Circuit**

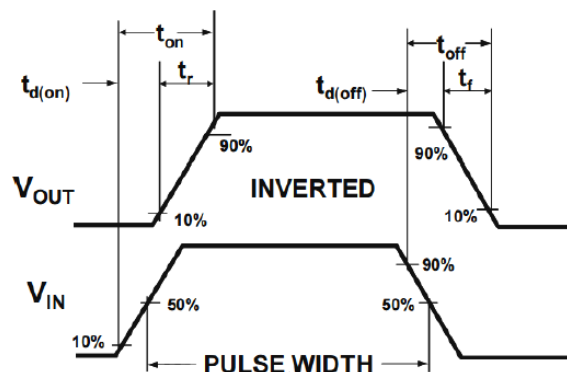

**Figure 2 Switching Waveform**

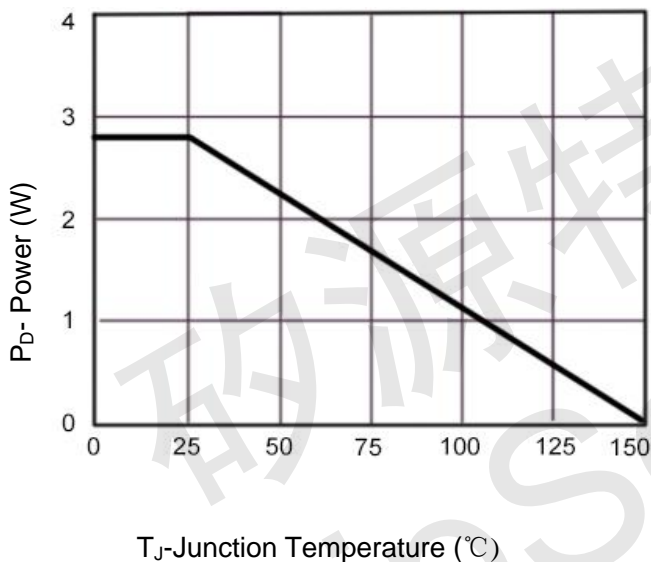

**Figure 3 Power De-rating**

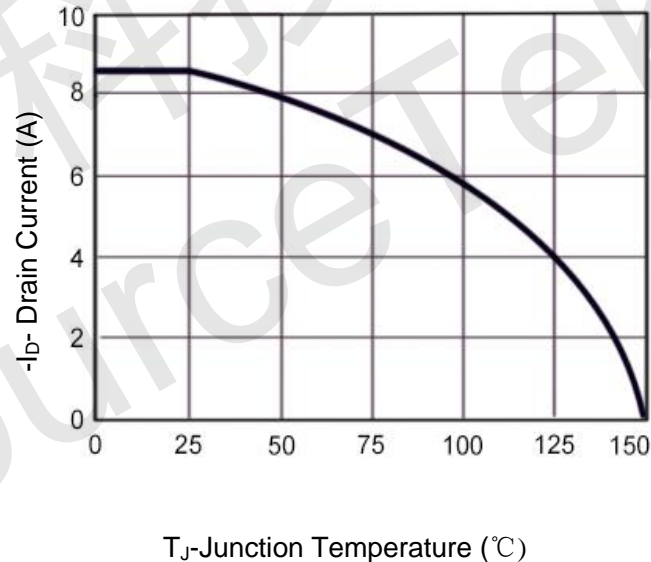

**Figure 4 Drain Current**

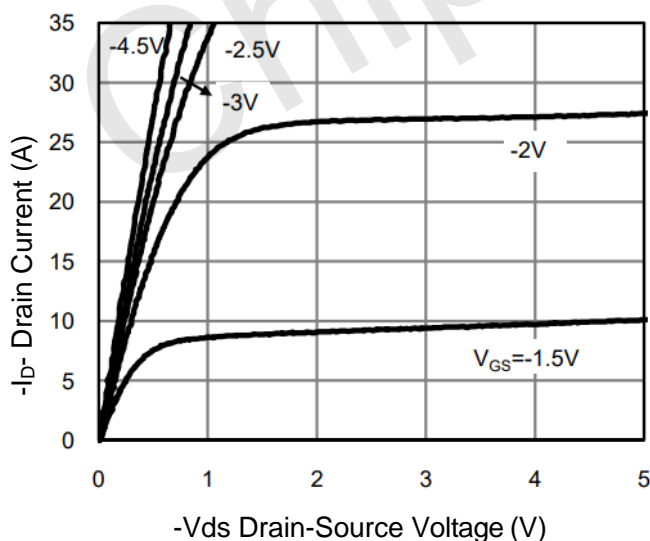

**Figure 5 Output Characteristics**

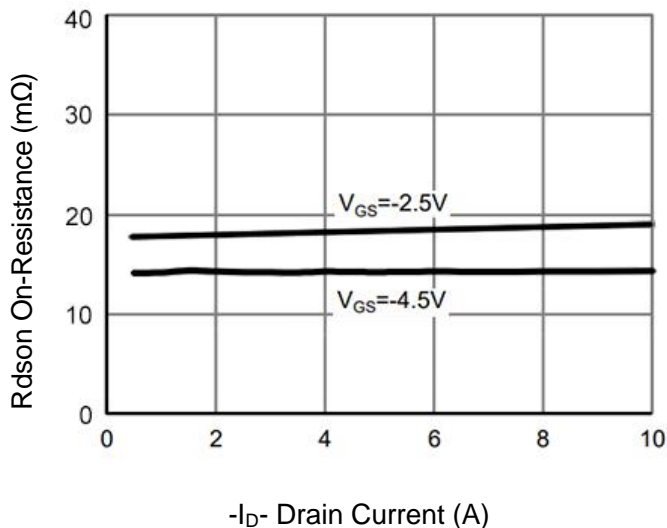

**Figure 6 Rdson vs Drain Current**

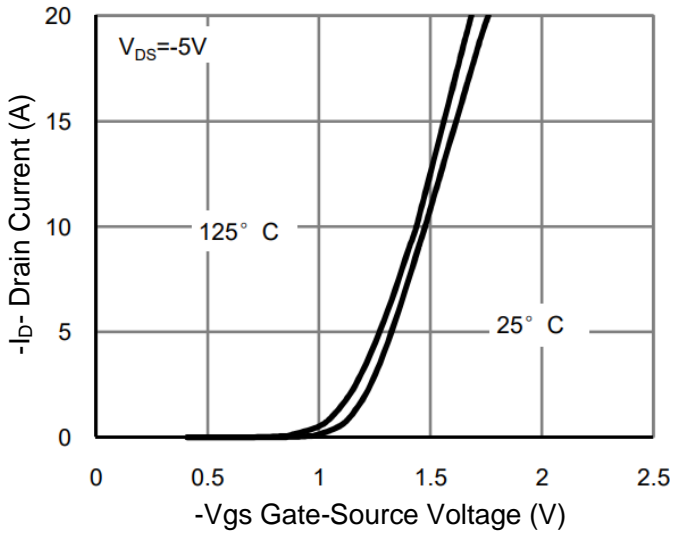

**Figure 7 Transfer Characteristics**

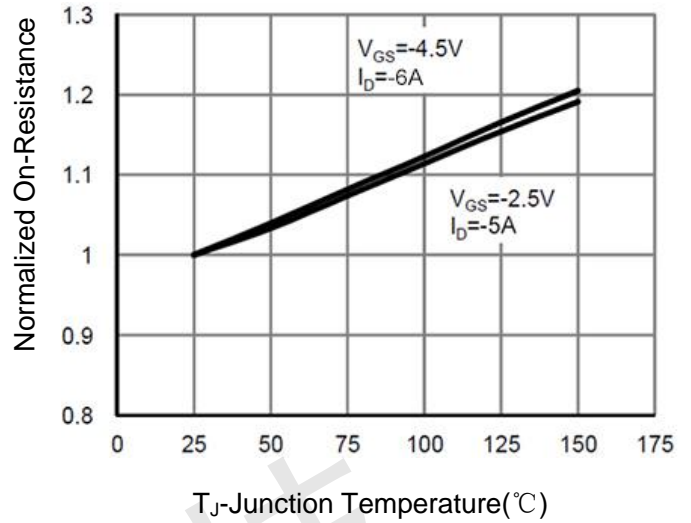

**Figure 8 Rdson vs Junction Temperature**

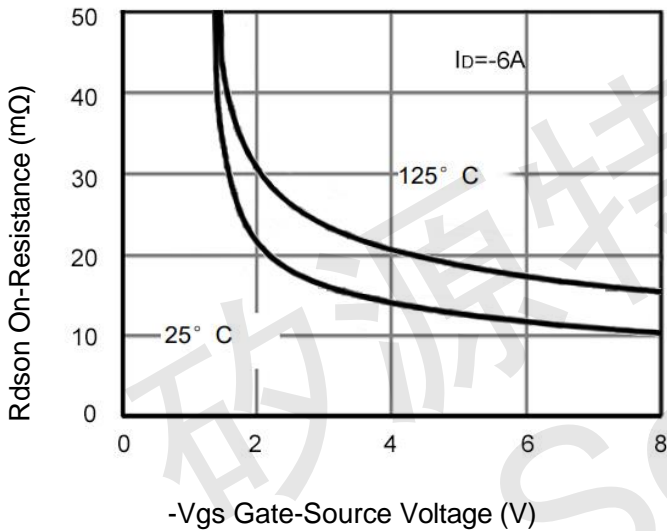

**Figure 9 Rdson vs Vgs**

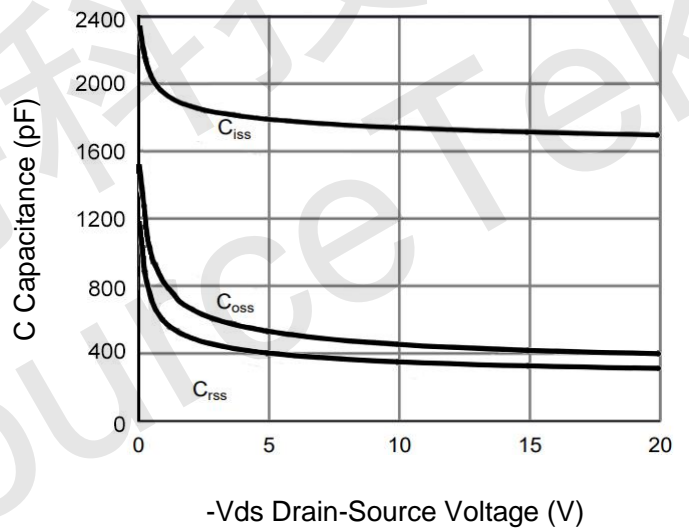

**Figure 10 Capacitance vs Vds**

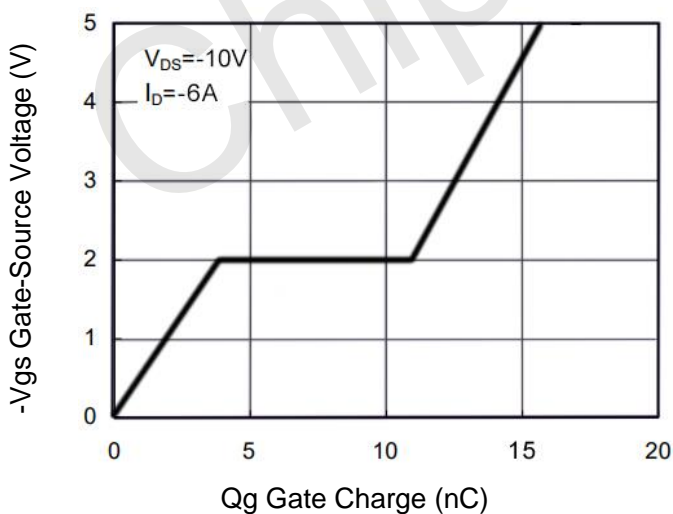

**Figure 11 Gate Charge**

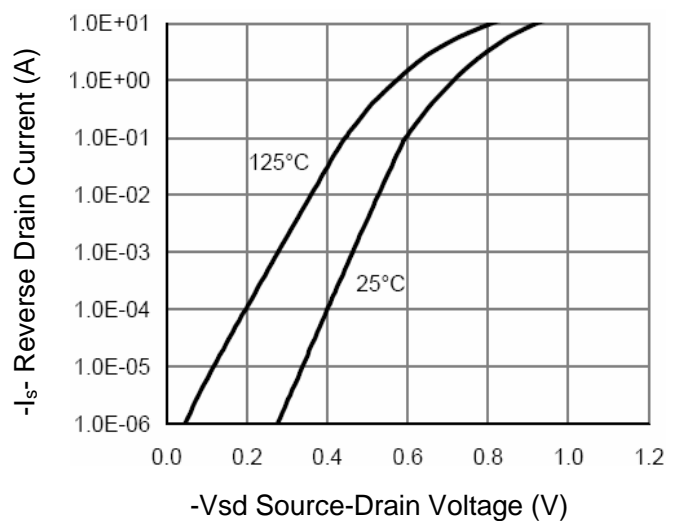

**Figure 12 Source- Drain Diode Forward**

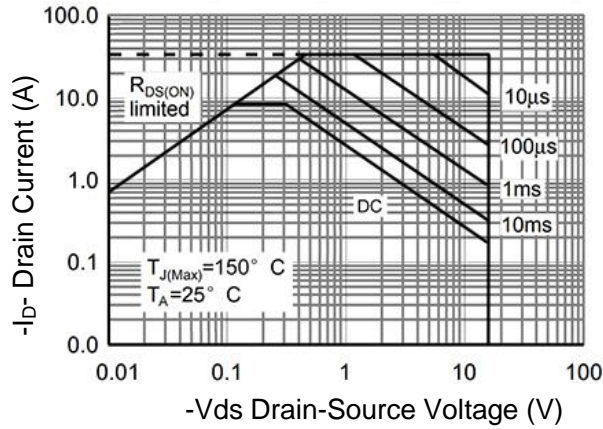

**Figure 13 Safe Operation Area**

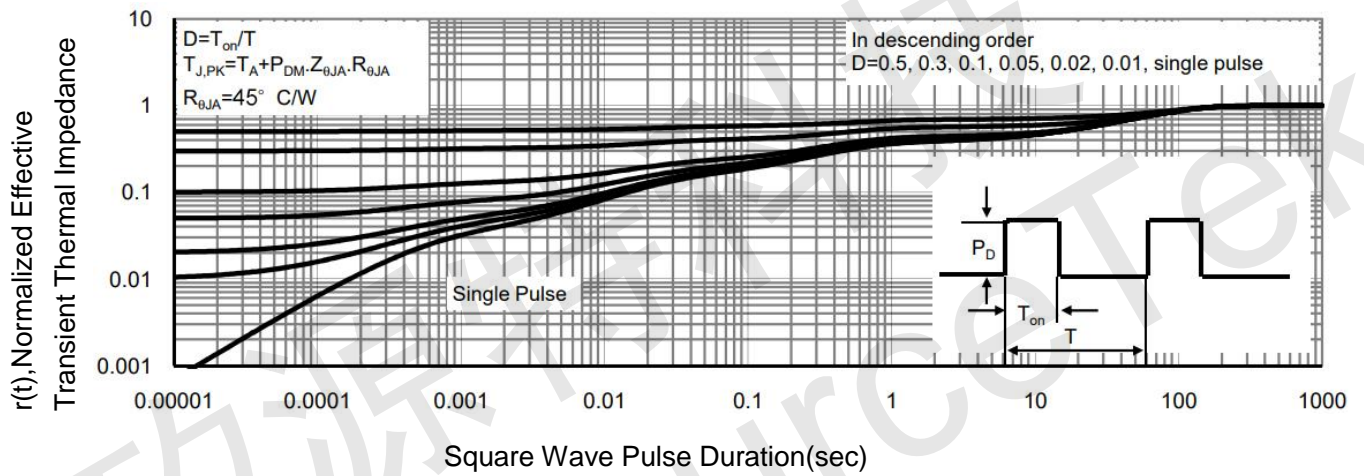

**Figure 14 Normalized Maximum Transient Thermal Impedance**



**UDFN2x2-6L Package Information**

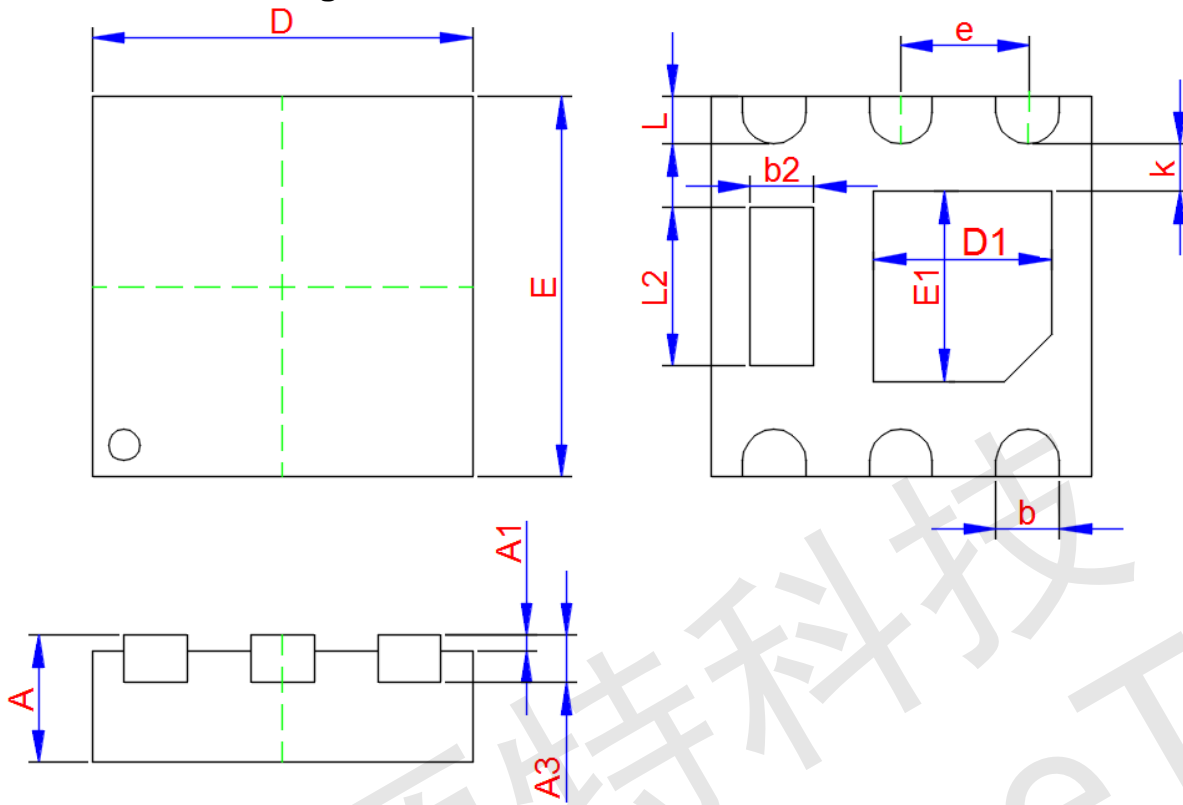

Symbol	Dimensions In Millimeters		
	Min.	Typ.	Max.
A	0.450	0.500	0.550
A1	0.000	-	0.050
A3	0.120	0.150	0.190
D	1.950	2.000	2.050
E	1.950	2.000	2.050
D1	0.970	1.000	1.030
E1	0.970	1.000	1.030
b	0.250	0.300	0.350
L	0.200	0.250	0.300
b2	0.250	0.300	0.350
L2	0.750	0.800	0.850
k	0.250MIN.		
e	0.650TYP.		