



**ZC8809**

**5.4W 电荷泵升压带 AB/D 类切换, 4 种防破音功能单声道音频功率放大器**

**概述**

ZC8809是一款带有自动增益控制功能，基于电荷泵升压技术，功率高达5.4W的AB/D切换音频功率放大器。内置独特的自适应升压功能，根据输出功率的大小自动选择由VDD供电或电荷泵升压整流供电，极大的延长了电池的播放时间。内置自动增益控制功能，可以根据输入信号大小自动调整放大器的增益防止失真，显著的提高音质。

**特性**

- ◆ AB类、D类切换功能
- ◆ 4种防破音可选
- ◆ 自适应升压功能，Charge\_pump升压至6.4V
- ◆ D类输出功率：
- ◆ -5.4W (VDD=4.5V, RL =4 Ω, NCN OFF THD+N=10%)
- ◆ -5.2W (VDD=4.2V, RL =4 Ω, NCN OFF THD+N=10%)
- ◆ AB类输出功率：
- ◆ -2W (VDD=4.2V, RL =4 Ω, 升压关闭 THD+N=10%)
- ◆ 工作电压：2.8V to 5.5V
- ◆ 低失真和低噪声
- ◆ 开启、关闭POP-click抑制功能
- ◆ 关断电流 (<1uA)
- ◆ OCP、OTP、UVLO 保护功能
- ◆ ESOP8 封装

**应用**

- ◆ 扩音器
- ◆ 便携式音箱 / 插卡音箱
- ◆ 蓝牙音箱 / AI 音箱

**典型应用电路图**

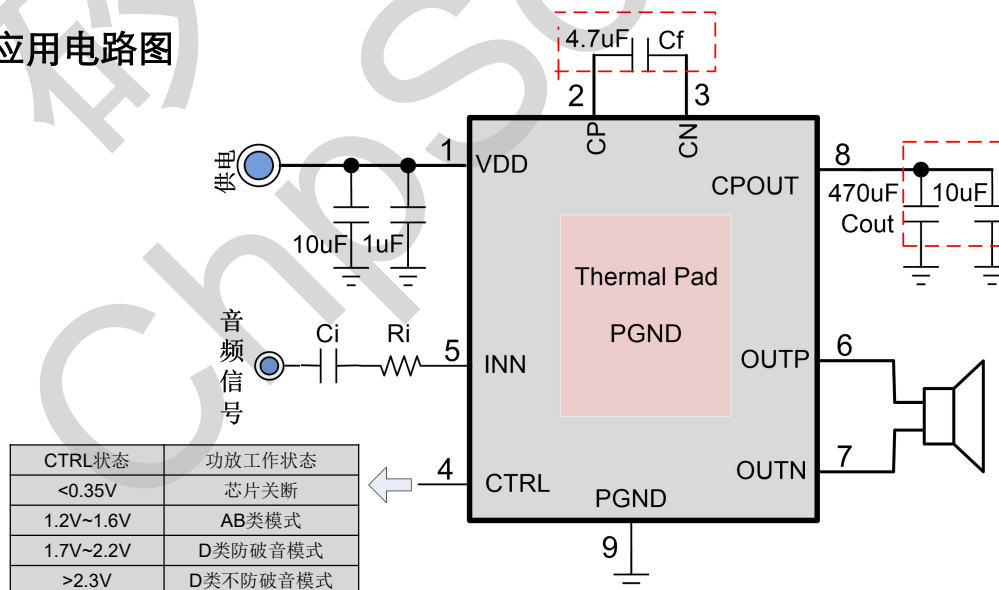

注：Cf电容靠近引脚摆放,推荐用4.7uF,耐压16V以上, Cout电容靠近引脚摆放推荐用470uF,耐压10V以上。



## 引脚排列

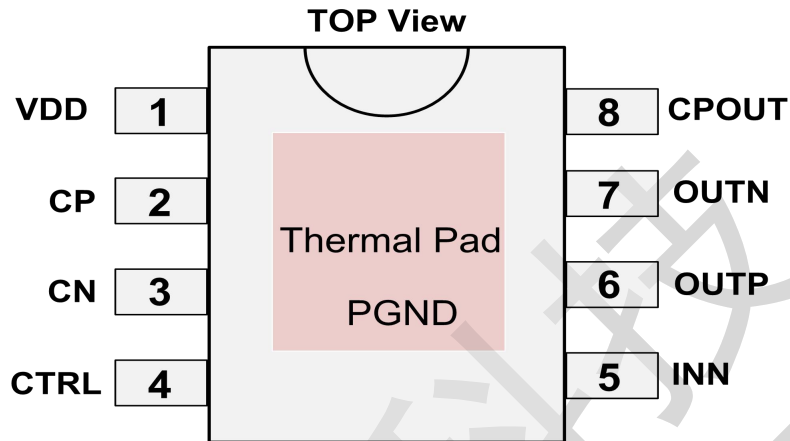

## 管脚描述

管脚	符号	I/O	描述
1	VDD	P	电源输入端
2	CP	I	Flying 电容正端
3	CN	I	Flying 电容负端
4	CTRL	I	工作使能控制, 电压控制 AB 类、D 类切换
5	INN	I	音频负输入端
6	OUTP	O	功放输出正端
7	OUTN	O	功放输出负端
8	CPOUT	O	电荷泵升压电源输出端
9(Thermal Pad)	PGND	P	功率地线



**ZC8809 5.4W 电荷泵升压带 AB/D 类切换,4 种防破音功能单声道音频功率放大器**

**Ordering Information**

Order Number	Package Type	Marking	Packing
ZC8809	ESOP8L	ZC8809 XXXXX	Reel Tape 4000pcs/Reel
			Tube 100pcs/Tube

**Absolute Maximum Ratings** (Over operating free-air temperature, unless otherwise noted)

V <sub>DD</sub>	Supply voltage	-0.3V to 5.5V
V <sub>I</sub>	Input voltage	-0.3V to V <sub>DD</sub> +0.3V
T <sub>A</sub>	Operation free-air temperate range	-40°C to 85°C
T <sub>J</sub>	Operation free-air junction temperature	-40°C to 125°C
T <sub>STG</sub>	Storage temperature range	-65°C to 150°C
T <sub>SLD</sub>	Soldering temperature	300°C, 5sec

**Recommended Operating Conditions**

Symbol	Parameter	Test Conditions	MIN	MAX	UNIT
V <sub>DD</sub>	Supply Voltage	V <sub>DD</sub>	2.8	5.0	V
V <sub>IH</sub>	SHDN Input High Voltage(Class AB)	V <sub>DD</sub> =2.8V to 5.0V	1.2	1.6	V
	SHDN Input High Voltage(Class D_NCN ON)		1.7	2.2	
	SHDN Input High Voltage(Class D_NCN OFF)		2.3	V <sub>DD</sub>	
V <sub>IL</sub>	SHDN Input Low Voltage		0	0.4	

**Thermal Information**

Parameter	Symbol	Package	MAX	UNIT
Thermal Resistance (Junction to Ambient)	θ <sub>JA</sub>	ESOP-8L	45	°C/W
Thermal Resistance (Junction to Case)	θ <sub>JC</sub>	ESOP-8L	10	°C/W

**ESD Range**

HBM Mode----- ±4kV

CDM Mode ----- ±2kV

TEL: +86-0755-27595155 27595165  
 FAX: +86-0755-27594792  
 WEB:Http://www.ChipSourceTek.com  
 E-mail: Tony.Wang@ChipSourceTek.com InFo@ChipSourceTek.com



ZC8809

5.4W 电荷泵升压带 AB/D 类切换,4 种防破音功能单声道音频功率放大器

**Class D Electrical Characteristics** ( $V_{DD}=4.2V$ , Gain=22.5dB,  $R=4\Omega$ ,  $T=25^{\circ}C$ , Unless otherwise noted.)

Symbol	Parameter	Test Conditions		MIN	TYP	MAX	UNIT
$V_{DD}$	Supply Power			2.8		5.5	V
$P_o$	CLASS D&NCN_OFF Output Power	THD+N=10%,f=1KHZ, $R_L=4\Omega$	$V_{DD}=4.5V$		5.45		W
			$V_{DD}=4.2V$		5.25		
			$V_{DD}=3.6V$		4.25		
		THD+N=1%,f=1KHZ, $R_L=4\Omega$	$V_{DD}=4.5V$		4.51		W
			$V_{DD}=4.2V$		4.31		
			$V_{DD}=3.6V$		3.72		
THD+N	Total Harmonic Distortion Plus Noise	$V_{DD}=4.2V$ , $P_o=1W$ , $R_L=4\Omega$	f=1KHz		0.1		%
		$V_{DD}=3.6V$ , $P_o=1W$ , $R_L=4\Omega$			0.2		
$G_v$	CLASS D Gain	$V_{DD}=4.2V$	$R_i = 20K\Omega$		22.5		dB
PSRR	Power Supply Ripple Rejection	$V_{DD}=4.2V \pm 100mV_{p-p}$	f=217Hz		-70		dB
SNR	Signal-to-Noise Ratio	$V_{DD}=4.2V$ , $V_{rms}=1V$ , GV=22.5dB	f=1KHz		-87		dB
$V_n$	Output Noise	$V_{DD}=4.2V$ , Input floating with $C_{IN}=0.1\mu F$	A-weighting		112		$\mu V$
			No A-weighting		143		
Dyn	Dynamic range	$V_{DD}=4.2V$ , THD=1%	f=1KHz		-98		dB
$I_Q$	Quiescent Current	$V_{DD}=4.2V$	No Load		3.5		mA
		$V_{DD}=2.8V$			3.0		
$\eta$	Efficiency	$V_{DD}=4.2V$ , $R_L=4\Omega$ , $P_o=2W$	f=1KHz		76		%
		$V_{DD}=3.6V$ , $R_L=4\Omega$ , $P_o=1W$	f=1KHz		71		
$r_{DS(on)}$	Source drain on resistance	$V_{DD}=5V$ , $I_o=500mA$	N+P		410		m $\Omega$
$F_{osc}$	Charge_pump Oscillator Frequency	$V_{IN}=2.8V$ to 5.0V			1200		kHz
	Class D Oscillator Frequency	$V_{IN}=2.8V$ to 5.0V			625		kHz
$R_{in}$	Internal input resistance	CLASS D model			20		K $\Omega$
$R_f$	Feedback resistance	CLASS D model			560		K $\Omega$
$I_{SD}$	Shutdown Current	$V_{IN}=0V$ , $V_{DD}=4.2V$			0.3	1	$\mu A$
$V_{os}$	Output Offset Voltage	$V_{IN}=0V$ , $V_{DD}=4.2V$	No Load		10	30	mV
$T_{st}$	Start Time		$V_{DD}=4.2V$		110		mS
OTP	Over Temperature Protection	No Load, Junction Temperature	$V_{DD}=5.0V$		165		$^{\circ}C$
OTH	Over Temperature Hysterisis				40		

TEL: +86-0755-27595155 27595165  
 FAX: +86-0755-27594792  
 WEB: Http://www.ChipSourceTek.com  
 E-mail: Tony.Wang@ChipSourceTek.com InFo@ChipSourceTek.com



ZC8809

5.4W 电荷泵升压带 AB/D 类切换,4 种防破音功能单声道音频功率放大器

**Class AB Electrical Characteristics** ( $V_{DD}=4.2V$ , Gain=19dB,  $R_L=4\Omega$ ,  $T=25^\circ C$ , Unless otherwise noted.)

Symbol	Parameter	Test Conditions		MIN	TYP	MAX	UNIT
$V_{DD}$	Supply Power			2.8		5.5	V
$P_o$	CLASS AB Output Power	THD+N=10%, $f=1KHZ$ , $R_L=4\Omega$	$V_{DD}=5.0V$		2.8		W
			$V_{DD}=4.2V$		2.0		
			$V_{DD}=3.6V$		1.5		
		THD+N=1%, $f=1KHZ$ , $R_L=4\Omega$	$V_{DD}=5.0V$		2.3		W
			$V_{DD}=4.2V$		1.5		
			$V_{DD}=3.6V$		1.2		
THD+N	Total Harmonic Distortion Plus Noise	$V_{DD}=4.2V$ , $P_o=1W$ , $R_L=4\Omega$	$f=1KHz$		0.35		%
		$V_{DD}=3.6V$ , $P_o=0.5W$ , $R_L=4\Omega$			0.28		
$G_v$	CLASS AB Gain	$V_{DD}=4.2V$	$R_i = 20K\Omega$		19		dB
PSRR	Power Supply Ripple Rejection	$V_{DD}=4.2V \pm 100mVp-p$	$f=217Hz$		-70		dB
SNR	Signal-to-Noise Ratio	$V_{DD}=4.2V$ , $V_{rms}=1V$ , $G_v=19dB$	$f=1KHz$		-88		dB
$V_n$	Output Noise	$V_{DD}=4.2V$ , Input floating with $C_{IN}=0.1\mu F$	A-weighting		75		$\mu V$
			No A-weighting		110		
Dyn	Dynamic range	$V_{DD}=4.2V$ , THD=1%	$f=1KHz$		-85		dB
$I_Q$	Quiescent Current	$V_{DD}=4.2V$	No Load		5.7		mA
		$V_{DD}=2.8V$			4.0		
$\eta$	Efficiency	$V_{DD}=4.2V$ , $R_L=4\Omega$ , $P_o=1W$	$f=1KHz$		66		%
$r_{DS(on)}$	Source drain on resistance	$V_{DD}=5V$ , $I_o=500mA$	N+P		410		$m\Omega$
$R_{in}$	Internal input resistance	CLASS AB mode			20		K $\Omega$
$R_f$	Feedback resistance	CLASS AB mode			375		K $\Omega$
$I_{SD}$	Shutdown Current	$V_{IN}=0V$ , $V_{DD}=4.2V$			0.3	1	$\mu A$
$V_{OS}$	Output Offset Voltage	$V_{IN}=0V$ , $V_{DD}=4.2V$		No Load	10	30	mV
$T_{st}$	Start Time	$V_{DD}=4.2V$			110		mS
OTP	Over Temperature Protection	No Load, Junction Temperature	$V_{DD}=5.0V$		165		$^\circ C$
OTH	Over Temperature Hysterisis				40		

TEL: +86-0755-27595155 27595165

FAX: +86-0755-27594792

WEB: [Http://www.ChipSourceTek.com](http://www.ChipSourceTek.com)

E-mail: [Tony.Wang@ChipSourceTek.com](mailto:Tony.Wang@ChipSourceTek.com) [InFo@ChipSourceTek.com](mailto:InFo@ChipSourceTek.com)



ZC8809

5.4W 电荷泵升压带 AB/D 类切换, 4 种防破音功能单声道音频功率放大器

## Class D Mode Typical Operating Characteristics

(VDD = 4.2V, Gain=22.5dB,  $R_L = 4\Omega$ , T = 25°C, unless otherwise noted.)

THD+N vs Output Power\_NCN OFF

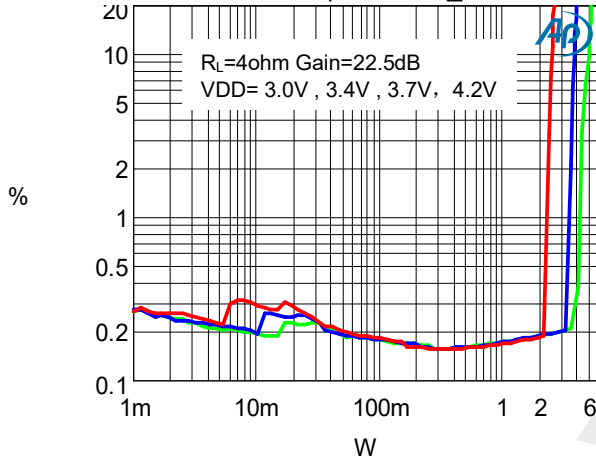

THD+N vs Output Power\_NCN ON

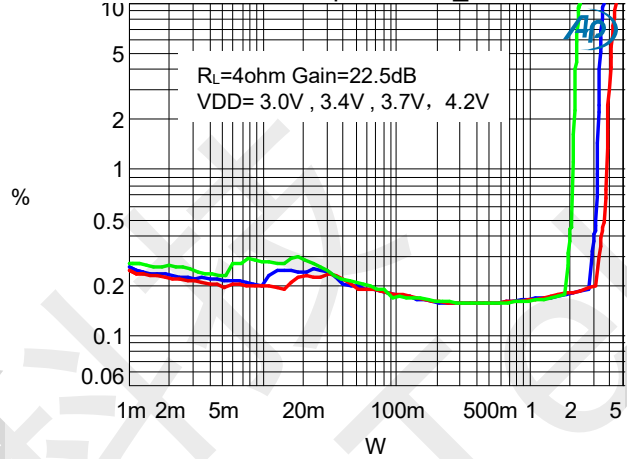

THD+N VS FRQUENCY

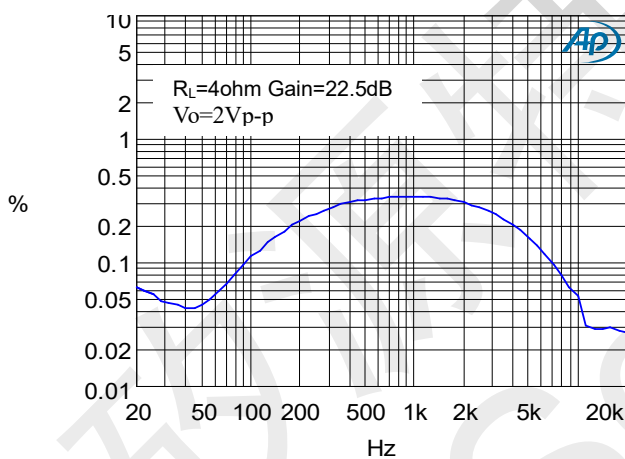

Frequency Response

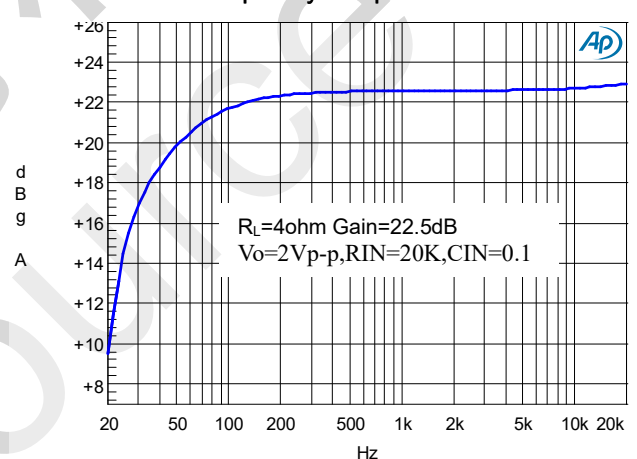

NOISE FLOOR FF

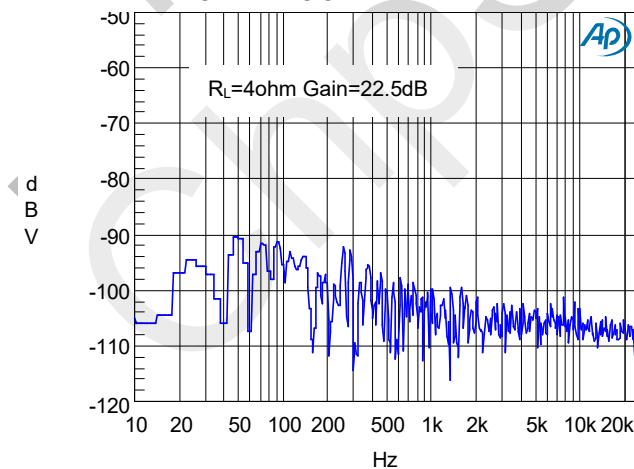





**ZC8809 5.4W 电荷泵升压带 AB/D 类切换,4 种防破音功能单声道音频功率放大器**

### Class AB Mode Typical Operating Characteristics

(VDD =4.2V, Gain=19dB, R<sub>L</sub> =4Ω, T =25°C, unless otherwise noted.)

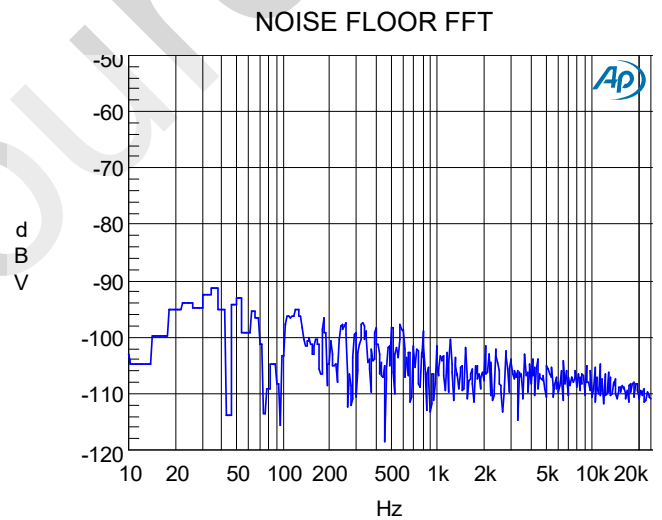
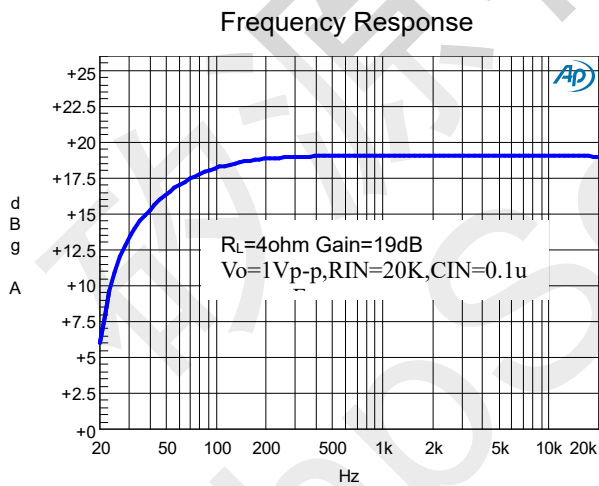
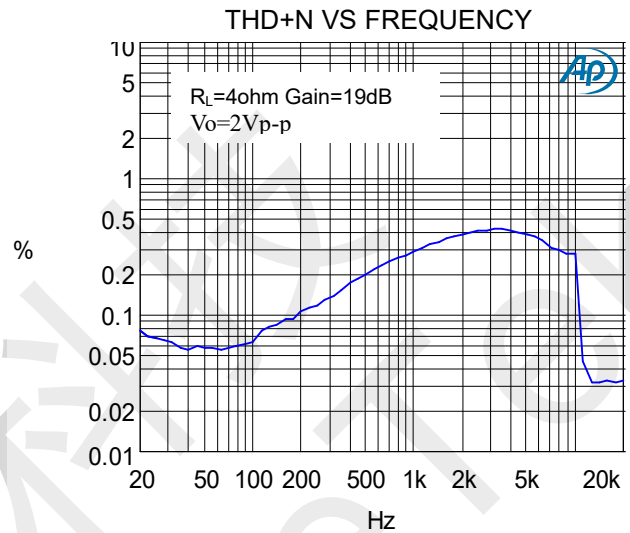
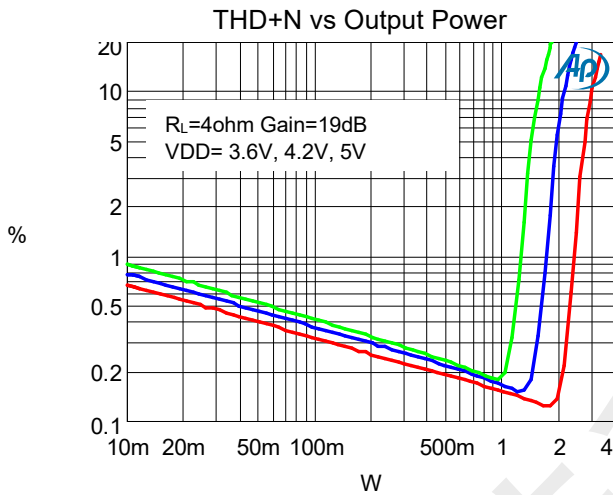



## ZC8809

## 5.4W 电荷泵升压带 AB/D 类切换, 4 种防破音功能单声道音频功率放大器

### 应用信息

#### 输入电阻(Rin)

ZC8809是单端的结构, PCB布局时这两个输入电阻尽可能的靠近ZC8809的管脚放置。这两种接法的增益设定是相同的。增益计算公式如下:

$$A_v = \frac{R_f}{R_{in} + 20K\Omega} \left( \frac{V}{V} \right)$$

其中, 输入电阻Rin为外部的输入电阻 (ZC8809内部集成输入电阻为20KΩ), 反馈电阻Rf分两种模式, D类模式时Rf为560KΩ; AB类时Rf为375K (反馈电阻为内部固定, 不可外部调节)。例如, D类模式时, 外部输入电阻为24KΩ, 则放大倍数为:

$$A_v = 560 / (24+20) = 12.7 \text{ 倍} = 22\text{dB}$$

#### 输入电容 (Cin)

输入电容与输入电阻构成一个高通滤波器, 其截止频率可由下式得出:

$$F_c = \frac{1}{2\pi * (R_{in} + 20K) * C_{in}}$$

Ci的值不仅会影响到电路的低频响应, 而且也会影响电路启动和关断时所产生的POP声, 输入电容越大, 则到达其稳定工作点所需的电荷越多, 在同等条件下, 小的输入电容所产生的POP声比较小。两个输入电容之间的良好匹配 (通常这两个输入电容容值一致) 对提升芯片的整体性能及开关机POP声有帮助。

#### AGC功能

在音频的实际应用中, 输入信号过大或供电电压下降等因素都会导致功放的输出信号发生破音失真。

ZC8809通过检测放大器输出信号的破音失真, 自动调整功放的增益以控制输出音频信号获得最大输出电平而不失真, ZC8809提供4种AGC防破音工作模式和不防破音工作模式可供用户选择 (切换方式另有说明)。

4种防破音模式的启动时间和释放时间, 具体如下图:

防破音模式	启动时间	释放时间
MODE1	32mS	100mS
MODE2	50mS	200mS
MODE3	55mS	130mS
MODE4	5mS	900mS

#### CTRL管脚控制

通过设置CTRL管脚的输入电平值, 可以分别进入ZC8809的各种工作模式, 如下表所示:

CTRL状态	功放工作状态
<0.35V	芯片关断
1.2V~1.6V	AB类模式
1.7V~2.2V	D类防破音模式
>2.3V	D类不防破音模式

根据不同的使能电压, 系统电路做如下电路设置:

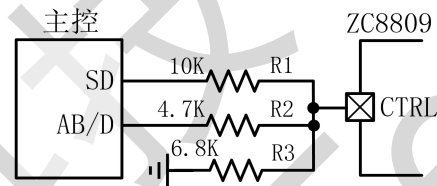

如上电路设置所示, 如果主控的IO口为3.3V, 借助SD及AB/D两个IO口以及分压线路实现各种模式切换, 当SD口及AB/D口同时为低电平时, 功放工作在关断状态; 当SD口为高电平, AB/D口悬空 (高阻状态), R1和R3构成分压, 此时CTRL引脚的电平1.33V ( $V_{CTRL} = V_{IO} * R_3 / (R_1 + R_3)$ ) 功放工作在AB类模式; 当SD口悬空 (高阻状态), AB/D口为高电平时, R2和R3构成分压, 此时CTRL引脚的电平为1.95V ( $V_{CTRL} = V_{IO} * R_3 / (R_2 + R_3)$ ) 此时工作在防破音模式;

#### Flying跨接电容Cf的选择

Flying跨接电容用于在电源和电荷泵之间传递能量, Flying跨接电容容值及电容ESR直接影响电荷泵的负载能力。Flying电容越大, 负载调整能力越强, 功放的输出功率越大。推荐使用4.7uF, 耐压16V以上低ESR的X7R、X5R陶瓷电容。

#### 升压输出滤波电容 (Cout)

电荷泵升压输出电容Cout的容值和ESR会直接影响电荷泵升压输出电压的稳定性, 从而影响功放的整体性能。推荐使用470uF低ESR的电解电容, 保持电容的耐压在10V以上。

#### 过温保护

ZC8809 有过温保护电路以防止内部温度超过 165°C 时器件损坏。在不同器件之间, 这个值有25°C的差异。当内部电路超过设置的保护温度时, 器件进入关断状态, 输出被截止。当温度下降 40°C后, 器件重新正常工作

TEL: +86-0755-27595155 27595165

FAX: +86-0755-27594792

WEB: Http://www.ChipSourceTek.com

E-mail: Tony.Wang@ChipSourceTek.com InFo@ChipSourceTek.com





ZC8809 5.4W 电荷泵升压带 AB/D 类切换,4 种防破音功能单声道音频功率放大器

封装图 (ESOP8L)

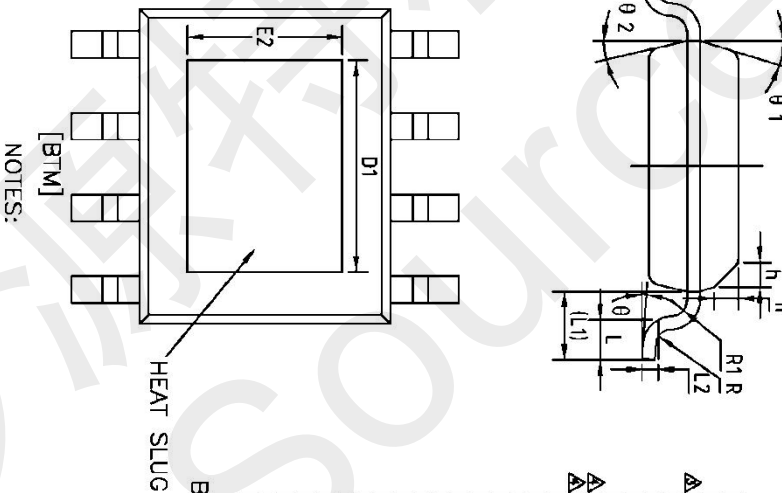
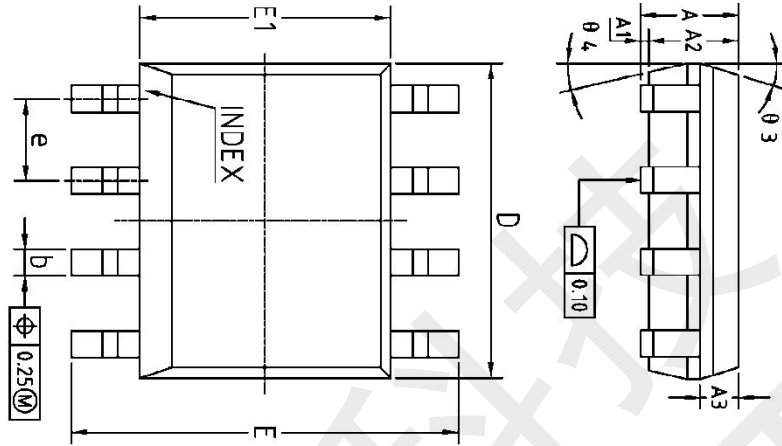

NOTES:  
ALL DIMENSIONS REFER TO JEDEC STANDARD MS-012 AA  
DO NOT INCLUDE MOLD FLASH OR PROTRUSIONS.

COMMON DIMENSIONS  
(UNITS OF MEASURE=MILLIMETER)

SYMBOL	MIN	NOM	MAX
A	1.35	1.55	1.75
A1	0	0.10	0.15
A2	1.25	1.40	1.65
A3	0.30	0.60	0.70
A4	0.38	-	0.51
b1	0.37	0.42	0.47
b2	0.17	-	0.25
c1	0.17	0.20	0.23
D	4.80	4.90	5.00
D1	3.10	3.50	3.50
E	5.80	6.00	6.20
E1	3.80	3.90	4.00
E2	2.20	2.40	2.60
e	-	1.2/BSG	-
L1	0.45	0.60	0.80
L2	-	1.04/REF	-
R1	0.07	-	-
R2	0.07	-	-
h	0.30	0.40	0.50
theta	0°	-	8°
theta 1	15°	17°	19°
theta 2	15°	15°	15°
theta 3	15°	17°	19°
theta 4	11°	13°	15°

SECTION B-B

声明： 公司保留在任何时间、没有任何通报的前提下修改产品资料和规格的权利。