



Built-in AGC with Two Limited Output Power Levels Class-D Audio Amplifier

General Description

The HAA9005 is a high efficiency filter-less Class-D audio power amplifier with Automatic Gain Control (AGC) technology. The device constantly monitors output power and dynamically adjusts internal gain to prevent long time overstress across the speaker.

The AGC with two limited output power levels control helps designer to select suitable output power which match the speaker.

The HAA9005 can deliver 0.6W or 0.85W continuous average power to an 8Ω load at 4.2V power supply. It features high efficiency up to 88%, which helps extend battery life when playing audio.

The HAA9005 features excellent output noise at gain=8V/V to improve the signal to noise ratio (SNR) in speaker mode.

The HAA9005 is available in small 1.5mmX1.5mm FCQFN-9 package with 500μm pitch.

Features

- ◆ Built-in AGC with Dual Output Power Levels
Control:0.6W@8Ω, 4.2V or 0.85W@8Ω, 4.2V
- ◆ Excellent Output Noise :
42μVrms @Gain=8V/V, A-weighted
- ◆ Improved PSRR :
-70dB@Speaker Mode(Gain=8V/V, A-weighted)
- ◆ High Efficiency : 88%
- ◆ Improved THD+N :
0.006%@ 0.5W, 8Ω, 1kHz
- ◆ Thermal and Short-circuit Protection with Auto Recovery
- ◆ Built-in Pop-and-click Noise Suppression
- ◆ Low RF Susceptibility
- ◆ Single Wire Pulse Control
- ◆ Available in 1.5mmX1.5mm FCQFN-9 Package

Applications

- ◆ Mobile Phones and Tablets
- ◆ Portable Media Players

Simplified Application Diagram

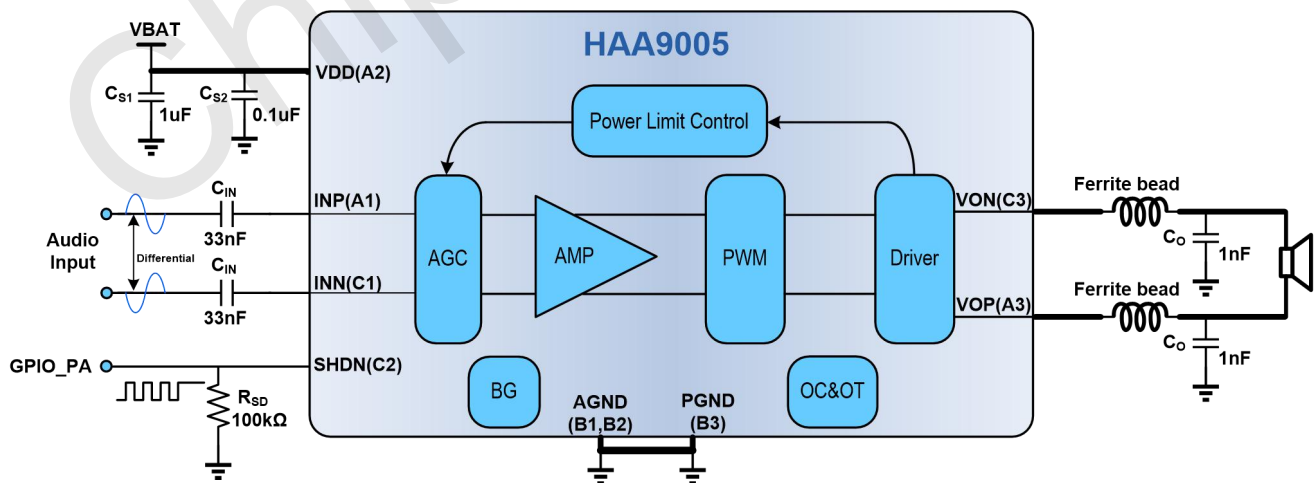



Built-in AGC with Two Limited Output Power Levels Class-D Audio Amplifier

Pin Configuration and Functions

HAA9005 TOP VIEW

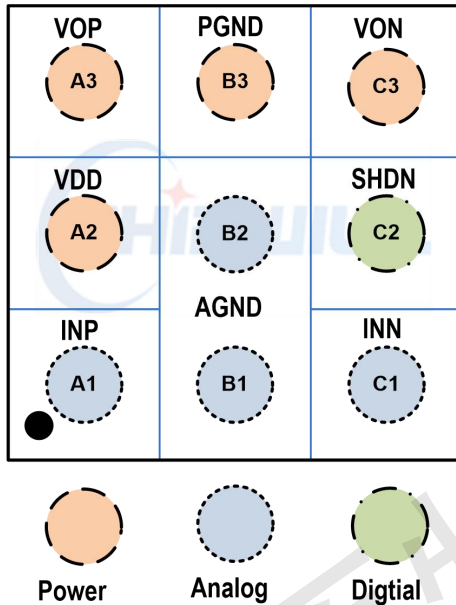

HAA9005 MARKING DIAGRAM

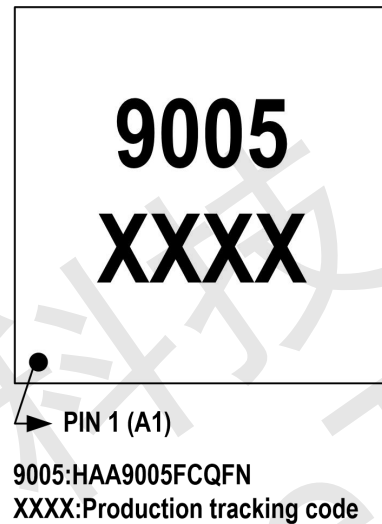

Table 1 Pin Functions

PIN No.	PIN Name	Description
A1	INP	Positive Audio Input
A2	VDD	Supply Voltage
A3	VOP	Positive PWM Audio Output
B1	AGND	Ground for Analog Circuits
B2	AGND	Ground for Analog Circuits
B3	PGND	Ground for Power Output Circuits
C1	INN	Negative Audio Input
C2	SHDN	Single Wire Pulse Control Terminal
C3	VON	Negative PWM Audio Output

Ordering Information

Device	Temperature Range	Package	Shipping
HAA9005FCQFN	-40°C to +85°C	FCQFN-9 1.5mmx1.5mm	3000 / Tape & Reel



Built-in AGC with Two Limited Output Power Levels Class-D Audio Amplifier

Absolute Maximum Ratings

Over operating free-air temperature range, $T_A = 25^\circ\text{C}$ (unless otherwise noted)⁽¹⁾

Parameter		Min	Max	Unit
Supply Voltage	VDD	-0.3	6	V
Input Voltage	INP,INN,SHDN	-0.3	VDD+0.3	V
Operating free-air temperature range T_A		-40	85	$^\circ\text{C}$
Operating junction temperature range T_J		-40	150	$^\circ\text{C}$
Storage temperature range T_{STG}		-65	150	$^\circ\text{C}$
Minimum load impedance		4		Ω
ESD ⁽²⁾				
Human Body Model (HBM) ESD			2000	V
Thermal Metric				
θ_{JA}	FCQFN-9 1.5mmx1.5mm		80	$^\circ\text{C/W}$

(1) Stresses beyond those listed under absolute maximum ratings may cause permanent damage to the device. These are stress ratings only, and functional operation of the device at these or any other conditions beyond those indicated under recommended operating conditions is not implied. Exposure to absolute-maximum-rated conditions for extended periods may affect device reliability.

(2) This device series contains ESD protection and passes the following tests:

Human Body Model (HBM) standard: MIL-STD-883J/Method 3015.8 for all pins.

Charged devices and circuit boards can discharge without detection. Although this product features patented or proprietary protection circuitry, damage may occur on devices subjected to high energy ESD. Therefore, proper ESD precautions should be taken to avoid performance degradation or loss of functionality.



Built-in AGC with Two Limited Output Power Levels Class-D Audio Amplifier

Electrical Characteristics

$V_{DD}=3.6V$, $T_A = 25^\circ C$, $R_L = 8\Omega + 33\mu H$, $C_{IN} = 33nF$ (unless otherwise noted)

Parameter	Symbol	Conditions	Min	Typ	Max	Unit
Supply Voltage Range	V_{DD}		2.8		5.5	V
Shutdown Current	I_{SD}			0.1	1	μA
Turn Off Time	T_{OFF}		100		500	μs
Single Wire Pulse (SHDN PIN)						
High-level Input Voltage	V_{IH}		1.35		V_{DD}	V
Low-level Input Voltage	V_{IL}		0		0.3	V
High-level Duration	T_{IH}		1		10	μs
Low-level Duration	T_{IL}		1		10	μs
Class-D Power Amplifier (PA)						
Operating Quiescent Current	I_Q	Input AC Ground, $V_{DD} = 3.6V$		2.5		mA
Turn-on Time	T_{ON}			40		ms
Output Offset Voltage	V_{OS}	Input AC Ground	-20		20	mV
Switching Frequency	F_{PA}			780		kHz
Voltage Gain	A_V	Mode1		8		V/V
		Mode2		12		V/V
		Mode6		12		V/V
Input Impedance	R_{IN}	Speaker Mode		28.5k		Ω
Efficiency	η	Mode6, $V_{DD} = 4.2V$, $P_O = 0.8W$, $R_L = 8\Omega + 33\mu H$		88		%
AGC Output Power	P_{OAGC}	Mode1, $V_{DD} = 4.2V$, $R_L = 8\Omega + 33\mu H$	0.540	0.600	0.660	W
		Mode1, $V_{DD} = 4.2V$, $R_L = 6\Omega + 33\mu H$	0.707	0.786	0.865	W
		Mode1, $V_{DD} = 4.2V$, $R_L = 4\Omega + 33\mu H$	1.036	1.151	1.266	W
		Mode2, $V_{DD} = 4.2V$, $R_L = 8\Omega + 33\mu H$	0.765	0.850	0.935	W
		Mode2, $V_{DD} = 4.2V$, $R_L = 6\Omega + 33\mu H$	0.992	1.102	1.212	W
		Mode2, $V_{DD} = 4.2V$, $R_L = 4\Omega + 33\mu H$	1.403	1.559	1.715	W
Output Noise Voltage	V_N	$C_{IN} = 33nF$, A-weighted, Mode1		42		μV
Output Impedance in Shutdown	Z_O	SHDN = 0		10k		Ω
Total Harmonic Distortion Plus Noise	THD+N	$V_{DD} = 4.2V$, $P_O = 0.1W$, $R_L = 8\Omega + 33\mu H$, $f = 1kHz$		0.008		%
		$V_{DD} = 4.2V$, $P_O = 0.3W$, $R_L = 8\Omega + 33\mu H$, $f = 1kHz$		0.005		%
		$V_{DD} = 4.2V$, $P_O = 0.5W$, $R_L = 8\Omega + 33\mu H$, $f = 1kHz$		0.006		%
		V 4 2V M d 2		-13.5		



Built-in AGC with Two Limited Output Power Levels Class-D Audio Amplifier

Electrical Characteristics

$V_{DD}=3.6V$, $T_A = 25^{\circ}C$, $R_L = 8\Omega + 33\mu H$, $C_{IN} = 33nF$ (unless otherwise noted)

Power Supply Ripple Rejection	PSRR	Input AC Ground, $V_{ripple} = 200mV_{pp}$, $V_{DD} = 4.2V$	217Hz	-72	dB
			1kHz	-70	
Signal Noise Ratio	SNR	$P_O = 1W$, $R_L = 8\Omega + 33\mu H$		97	dB
Output Power	P_O	$V_{DD} = 4.2V$, THD+N = 10%, $R_L = 8\Omega + 33\mu H$		1.26	W
		$V_{DD} = 4.2V$, THD+N = 1%, $R_L = 8\Omega + 33\mu H$		1.04	
		$V_{DD} = 4.2V$, THD+N = 10%, $R_L = 4\Omega + 33\mu H$		1.89	
		$V_{DD} = 4.2V$, THD+N = 1%, $R_L = 4\Omega + 33\mu H$		1.54	
AGC Attack Time	T_{ATK}	$V_{DD} = 4.2V$, Mode1, $V_{IN} = 1.5V_p$		45	ms
		$V_{DD} = 4.2V$, Mode2, $V_{IN} = 1.5V_p$		50	
AGC Release Time	T_{REL}	$V_{DD} = 4.2V$, Mode1		0.9	s
		$V_{DD} = 4.2V$, Mode2		1.1	
AGC Gain Step Size		Voltage Step		0.5	dB
Max Attenuation Gain		$V_{DD} = 4.2V$, Mode1		-11	dB
		$V_{DD} = 4.2V$, Mode2		-13.5	



Built-in AGC with Two Limited Output Power Levels Class-D Audio Amplifier

Operating Control Description

Figure 1. Single Wire Pulse Control Timing Sequence

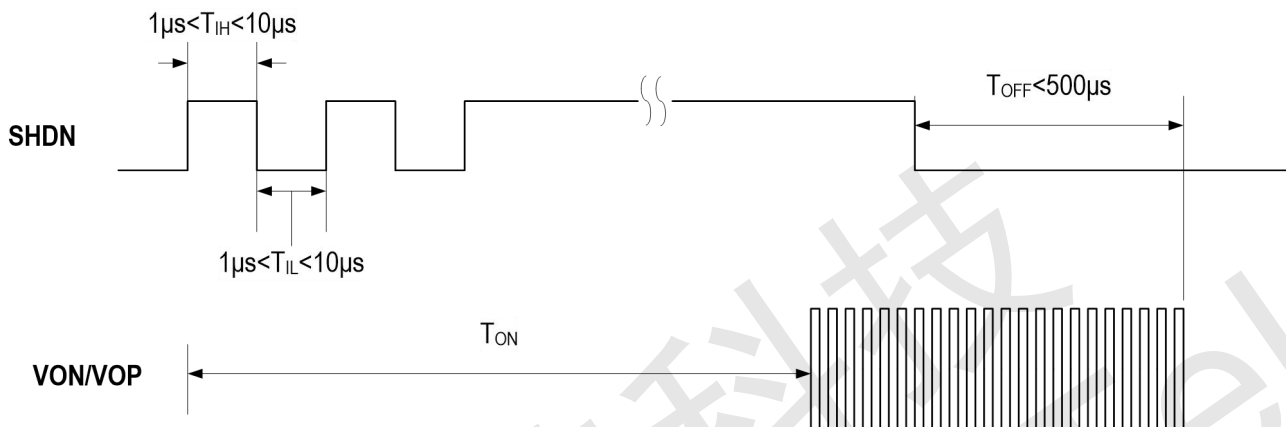

Table 2 Operation Mode Description

Control Signal of SHDN PIN	Mode	Description
Mode1	Mode 1	AGC ON, 0.6W@8Ω Output Power ⁽¹⁾
Mode2	Mode 2	AGC ON, 0.85W@8Ω Output Power ⁽¹⁾
Mode6	Mode 6	AGC OFF

(1) The 0.6W, 0.85W is approximate value, you can get the exact value in "Electrical Characteristics".



Built-in AGC with Two Limited Output Power Levels Class-D Audio Amplifier

Typical Characteristics

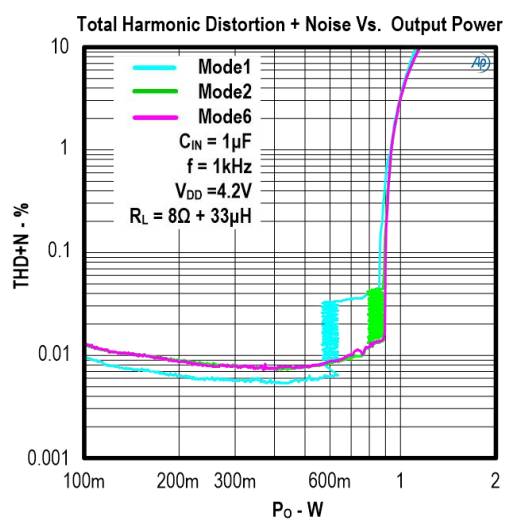
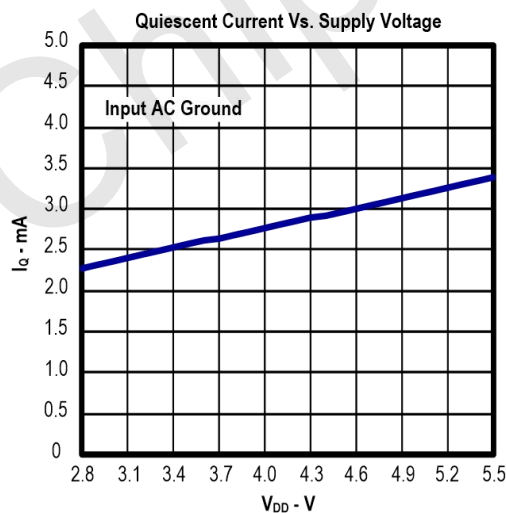
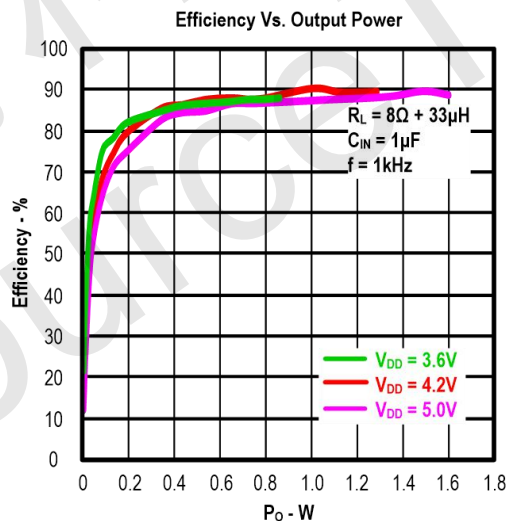
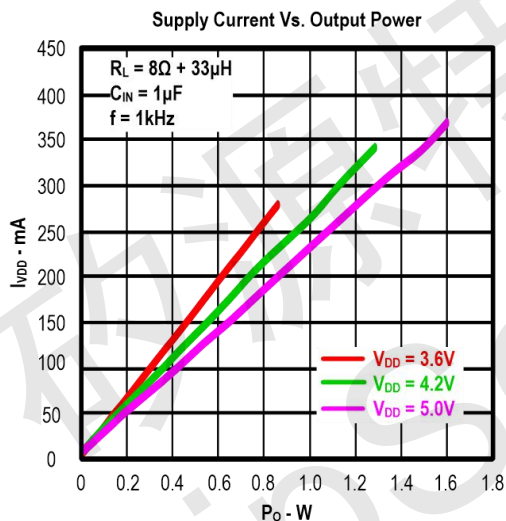
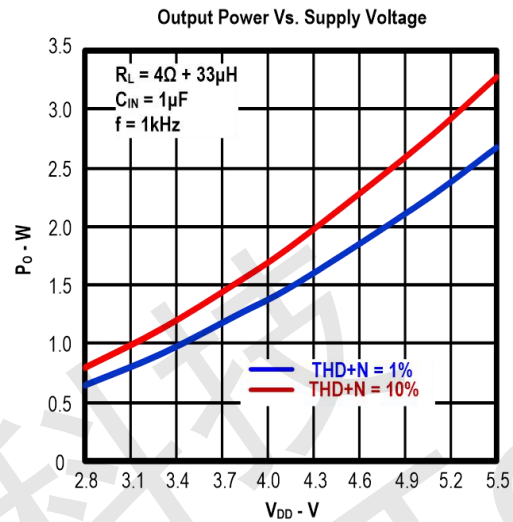
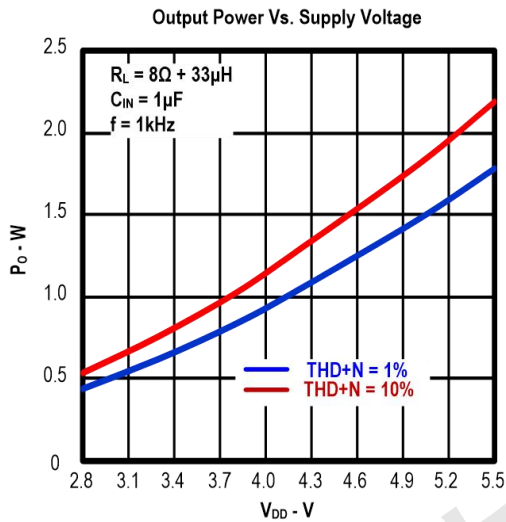



Built-in AGC with Two Limited Output Power Levels Class-D Audio Amplifier

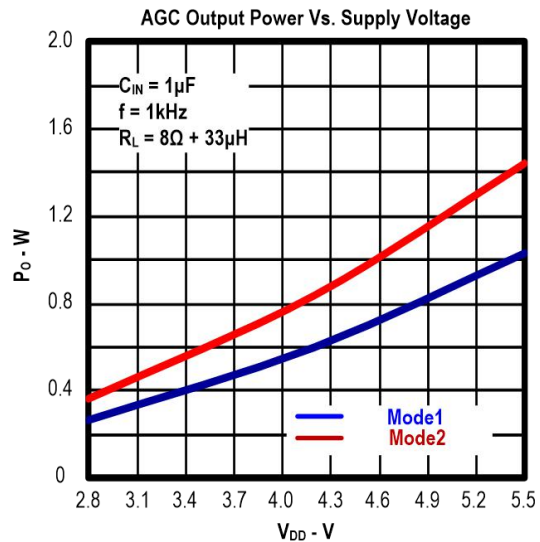
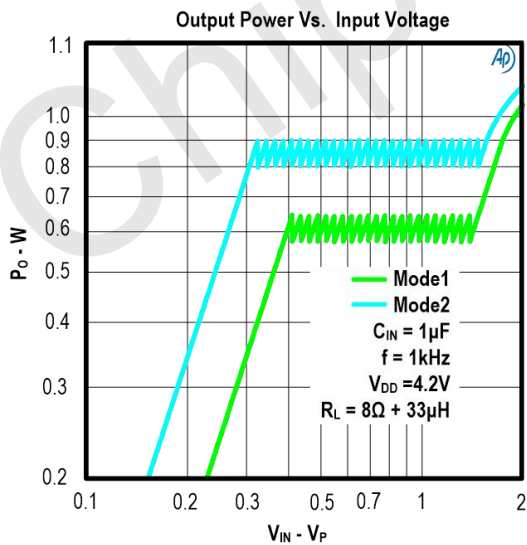
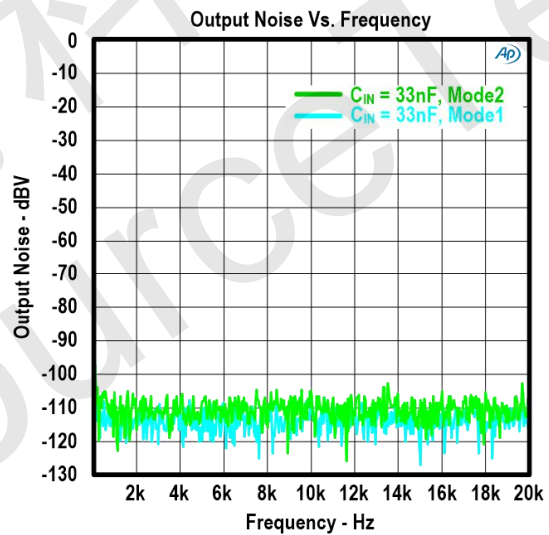
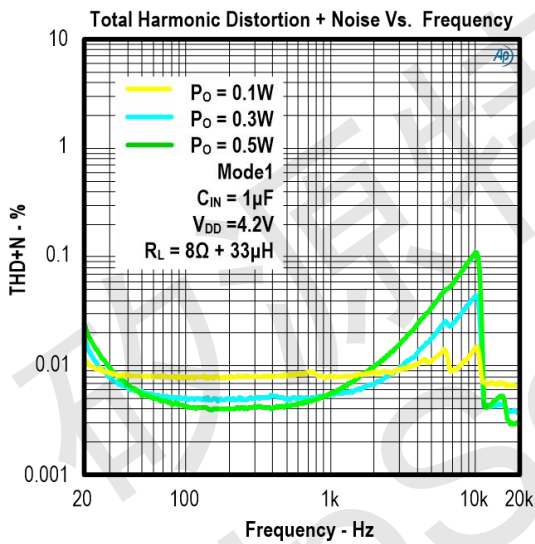
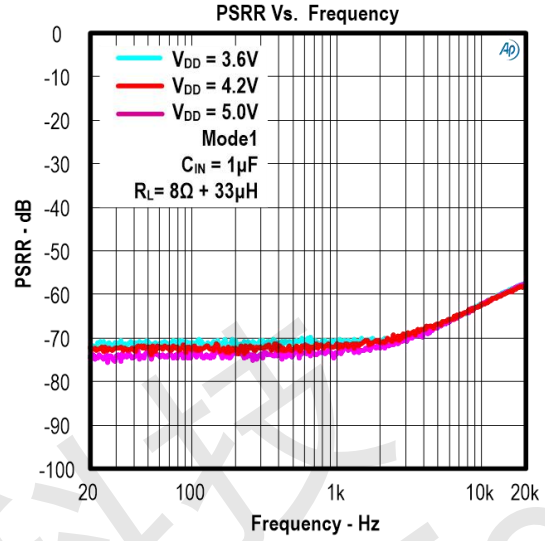
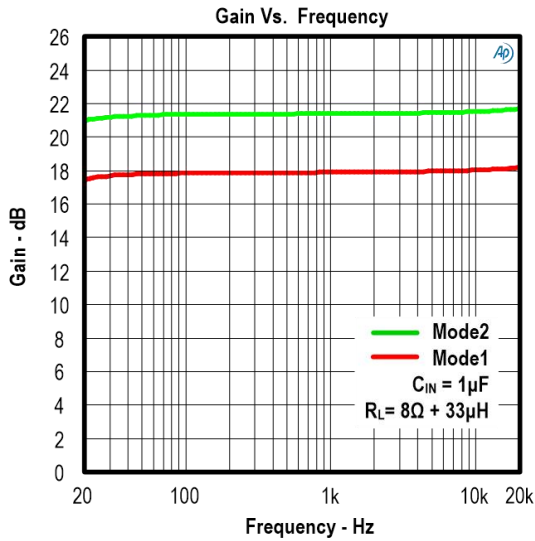



Built-in AGC with Two Limited Output Power Levels Class-D Audio Amplifier

Turn ON Timing

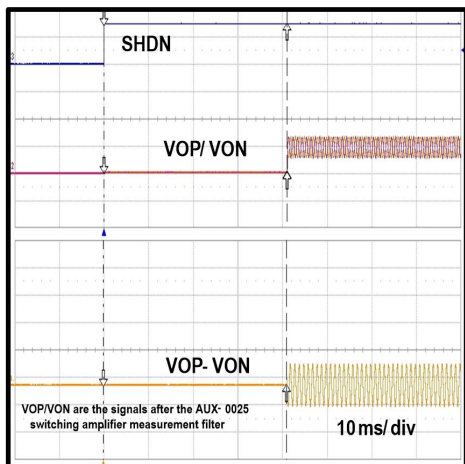

Turn OFF Timing

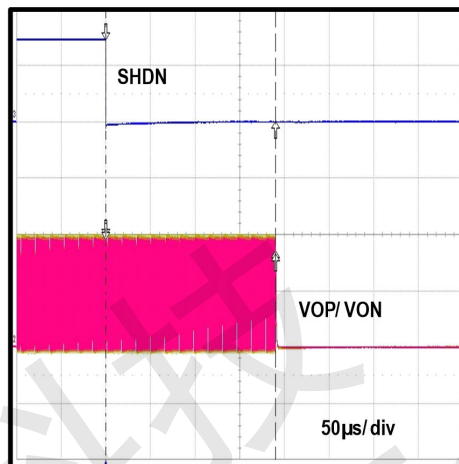

AGC Attack Time

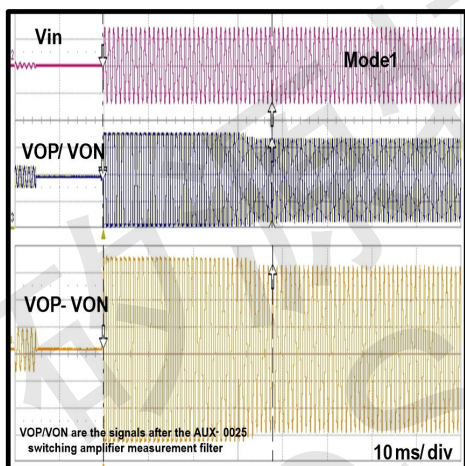

AGC Release Time

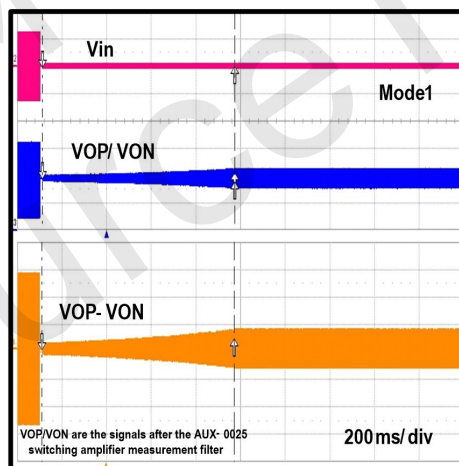



Built-in AGC with Two Limited Output Power Levels Class-D Audio Amplifier

Functional Description

The HAA9005 is a high efficiency filter-less Class-D audio power amplifier with Automatic Gain Control (AGC). The AGC with two limited output power levels control helps designer to select suitable output power which match the speaker.

Fully Differential Class-D Amplifier

The HAA9005 features a filter-less modulation scheme that reduces external component count, conserving board space and reducing system cost. With no signal applied, the outputs switch between VDD and GND with 50% duty cycle, in phase, causing the two outputs to cancel. This cancellation results in no net voltage across the speaker, thus there is no current to the load in the idle state.

With an input signal applied, the duty cycle (pulse width) of the Class-D output changes. For increasing output voltage, the duty cycle of VOP increases, while the duty cycle of VON decreases. For decreasing output voltages, the converse occurs. The difference between the two pulse widths yields the differential output voltage.

The HAA9005 uses a fully differential amplifier with differential inputs and outputs. The differential output voltage equals the differential input multiplied by the amplifier gain. The HAA9005 can also be used with a single-ended input. However, using differential input signals when in a noisy environment, like a wireless handset, ensures maximum system noise rejection.

Single Wire Pulse Control

The HAA9005 implements a single wire pulse method to control the operation mode. Users can easily select the mode that needed by applying a serial pulse signal to the SHDN pin. The detail operation is showed in the Figure1 .

Mode Switch Timing Sequence

In order to avoid entering an error state, HAA9005 should be powered up first, and then input control signal. When the operating mode need to be changed, SHDN should be pulled down more than 1ms, and then input the new control signal (see Figure 2).

Figure 2. Operating Mode Switch Timing Sequence



Shutdown Mode

The HAA9005 can be put in shutdown mode when asserting SHDN pin to a logic LOW. While in shutdown mode, the device output is turned off and set into high impedance, making the current consumption very low. The device exits shutdown mode when a HIGH logic level is applied to the SHDN pin.

Auto Gain Control (AGC)

The AGC feature provides continuous automatic gain adjustment to the amplifier through an internal PGA. It continuously monitors the output and adjusts the gain of the loudspeaker amplifier signal path if necessary. This feature enhances the perceived audio loudness and at the same time prevents speaker damage from overload condition. The gain changes constantly as the audio signal increases or decreases with 0.5dB per voltage step (1dB per power step). If the audio signal has near-constant amplitude, the gain does not change.

The AGC protects the speaker by limiting long-term high output power on the load. Figure 3 shows how the AGC power is defined.



Built-in AGC with Two Limited Output Power Levels Class-D Audio Amplifier

Figure 3. Output Power Vs. Input Signal Diagram Showing How AGC Power is Defined

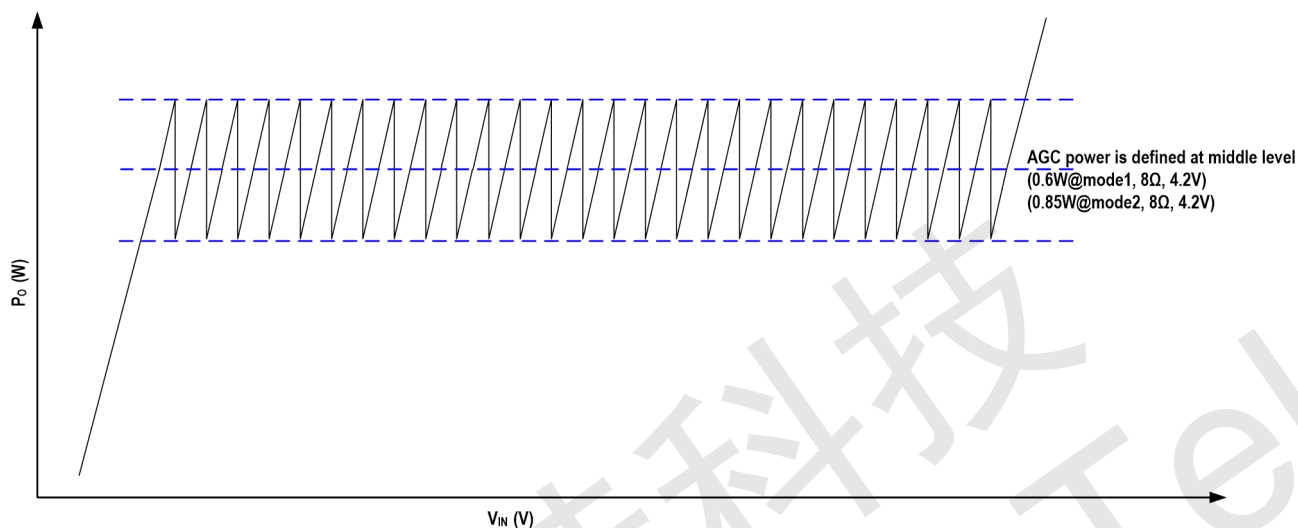

Short Circuit Protection

The HAA9005 has short circuit protection circuitry on the outputs to prevent the device from damage when output-to-output shorts or output-to-GND shorts occur. When a short circuit occurs, the device immediately goes into shutdown state. Once the short is removed, the device is released from shutdown automatically and will be re-popped.

Over Temperature Protection

An internal over temperature protection circuits turns off the device when the typical junction temperature is exceeded. The device is released from shutdown automatically when the junction temperature decreases.



Built-in AGC with Two Limited Output Power Levels Class-D Audio Amplifier

Application Information

Components Selection

Use very low ESR ceramic capacitors (X5R/X7R) will help to reduce the output resistance and thus improve the system efficiency. Capacitors constructed using X5R (-55°C to +85°C) or X7R (-55°C to +125°C) dielectric materials are preferred because they are compact, feature low ESR and are sufficiently stable over a wide temperature range. The capacitance value decreases over the DC biasing voltage range (50% to 85% decrease). Consequently, the selected capacitor should have a nominal value that is three to four times higher than the required minimum effective capacitance.

Decoupling Capacitor (C_S)

The HAA9005 is a high-performance Class-D audio amplifier that requires adequate power supply decoupling to ensure the efficiency is high and total harmonic distortion (THD) is low. For higher frequency transients, spikes, or digital hash on the line, a good low equivalent-series-resistance (ESR) ceramic capacitor, typically 1μF, placed as close as possible to the device V_{DD} pin works best. Placing this decoupling capacitor close to the HAA9005 is important for the efficiency of the Class-D amplifier, because any resistance or inductance in the trace between the device and the capacitor can cause a loss in efficiency. For filtering higher-frequency noise signals, a 0.1μF capacitor placed near the audio power amplifier would also help.

Beam Filters

A ferrite bead filter can often be used if the design is failing radiated emissions without an LC filter and the frequency sensitive circuit is greater than 1MHz. This filter functions well for circuits that just have to pass FCC and CE because FCC and CE only test radiated emissions greater than 30MHz. When choosing a ferrite bead, choose one with high impedance at high frequencies, and low impedance at low frequencies. In addition, select a ferrite bead with adequate current rating to prevent distortion of the output signal. Use an LC output filter if there are low frequency (<1MHz) EMI sensitive circuits and/or there are long leads from amplifier to speaker. When use filter, it should be placed as close as possible to the device VOP/VON pin.

Input Capacitors (C_{IN})

The HAA9005 has internal input resistors (R_{IN}) of 28.5kΩ. The input capacitors and input resistors form a high-pass filter with the corner frequency, f_c, determined in equation below.

$$f_c = \frac{1}{2\pi * C_{IN} * 28.5k\Omega}$$

The value of the input capacitor is important to consider as it directly affects the bass (low frequency) performance of the circuit. Speakers in wireless phones cannot usually respond well to low frequencies, so the corner frequency can be set to block low frequencies in this application. If the corner frequency is within the audio band, the capacitors should have a tolerance of ±10% or better, because any mismatch in capacitance causes an impedance mismatch at the corner frequency and below, it may cause turn-on pop noise.

Input Signal Wire Layout

The audio signal wires between baseband and HAA9005 should line in the inner layer, and they also should be shielded with ground on both sides. In single ended input application, the ground of the input signal need to try to close base-band, in order to avoid the coupling noise (see Figure4, Figure5).



Built-in AGC with Two Limited Output Power Levels Class-D Audio Amplifier

Figure 4. Differential Input Signal Layout

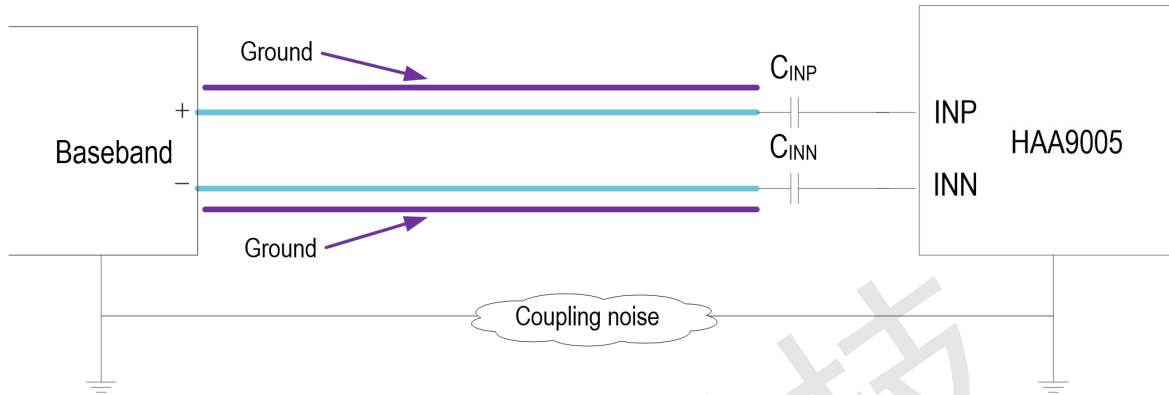
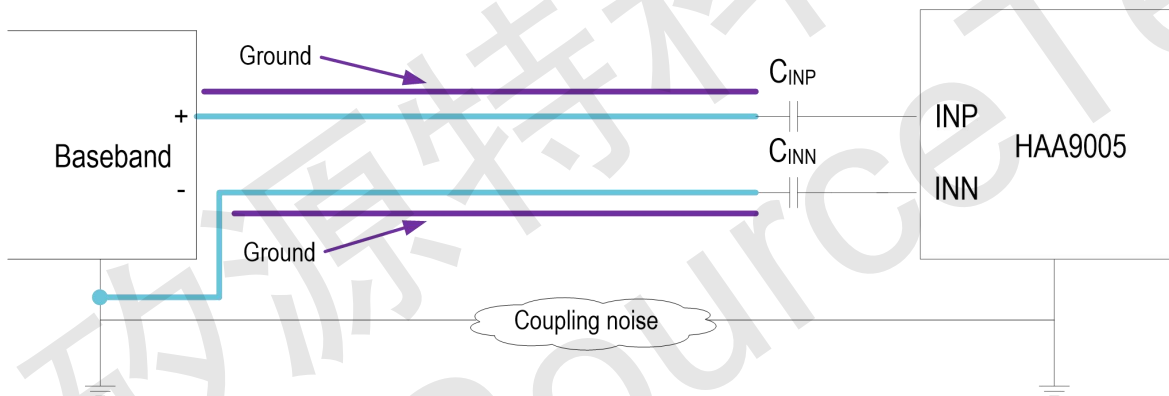

Figure 5. Single-Ended Input Signal Layout





Built-in AGC with Two Limited Output Power Levels Class-D Audio Amplifier

Revision History

Version	Release Date	Change Notice
V1.0	Dec 2019	First Official Version Release

矽源特科技
ChipSourceTek



Built-in AGC with Two Limited Output Power Levels Class-D Audio Amplifier

Package Outline

1.5mmX1.5mm FCQFN-9 Package

HAA9005

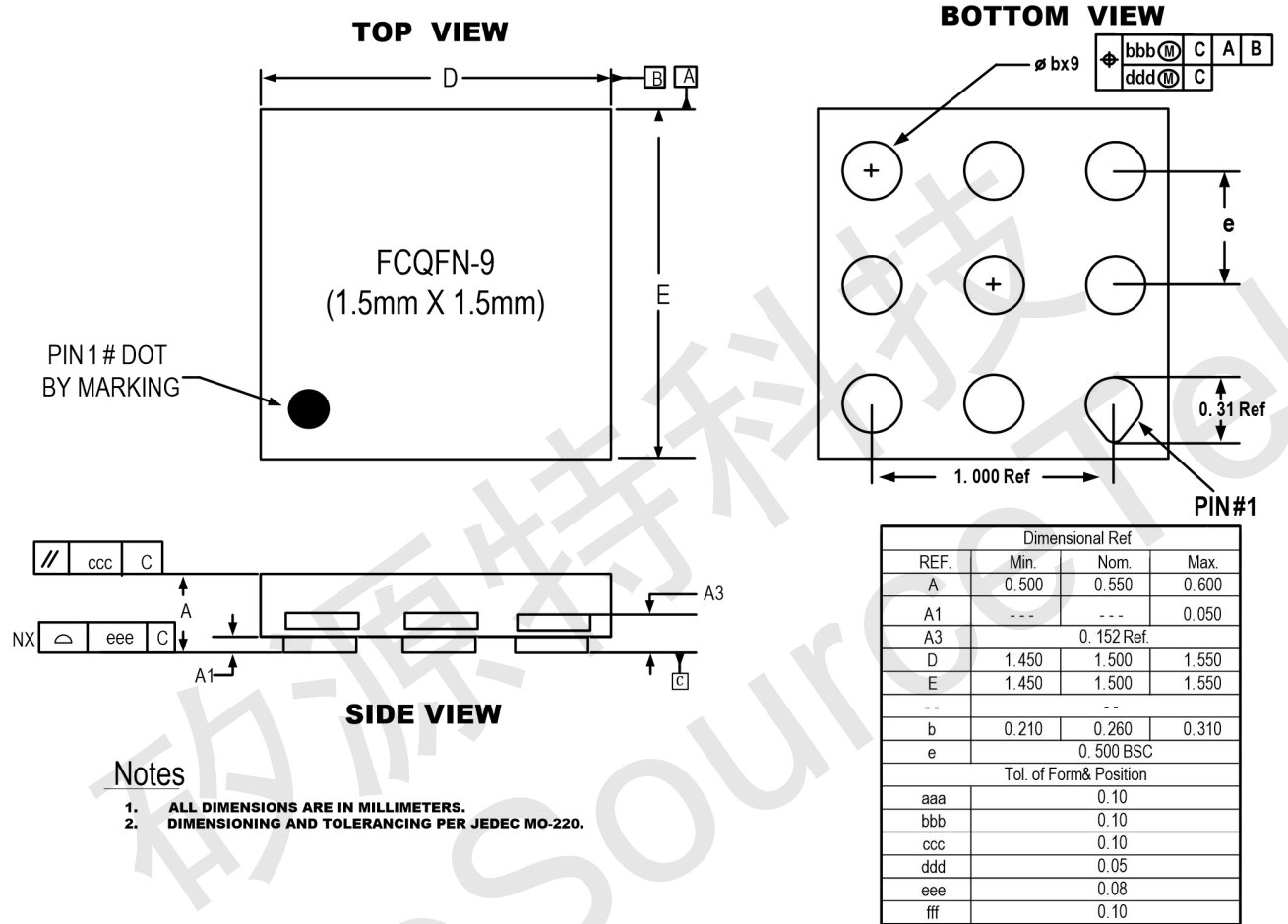

Notes

1. ALL DIMENSIONS ARE IN MILLIMETERS.
2. DIMENSIONING AND TOLERANCING PER JEDEC MO-220.

All rights reserved. Reproduction in whole or in part is prohibited without the prior written consent of the copyright owner. The information presented in this document does not form part of any quotation or contract, is believed to be accurate and reliable and may be changed without notice. No liability will be accepted by the publisher for any consequence of its use. Publication thereof does not convey nor imply any license under patent- or other industrial or intellectual property rights.