



Adaptive Charge-Pump, Receiver-Mode Class G Audio Amplifier

General Description

The HAA9007 is a high efficiency filter-less Class-G audio power amplifier with Automatic Gain Control technology and an adaptive high efficiency charge pump boost power supply. The device constantly monitors output power and dynamically adjust internal gain to prevent long time overstress across the speaker.

The adaptive charge pump structure activates automatically depending on the output signal. It generates 6V supply for output stage of amplifier when the peak output voltage is high. It can deliver 1W (THD+N=1%) of continuous average power to an 8Ω load by a lithium/Ion battery. The HAA9007 features high efficiency up to 81%, which helps extend battery life when playing audio.

The AGC features multi-level constant output power, which can improve sound quality and suppress the clipping noise. It also helps designer to select suitable output power which match the speaker.

The HAA9007 has a 48μVrms low output noise at gain=8V/V to improve the signal to noise ratio (SNR).

The HAA9007 is available in small 1.57mmX1.61mm 14-ball WLCSP package with 400μm pitch.

Features

- Built-In AGC technology
- 4 Constant Output Power levels Control:
1.2W ,1W ,0.8W ,0.6W@8Ω
- Adaptive Charge Pump Power Supply
- Low Output Noise : **48μVrms @ gain=8V/V**
- Built-in Class AB Receiver mode
- SNR:98dB (3.8V,8Ω)
- High Efficiency : **81%**
- Low quiescent current: 3.8mA (3.8V)
- 2.18W Output Power (8Ω @ 4.2V, THD+N=10%)
- THD+N:0.006%@1kHz,800mW,8Ω Load,3.8V Supply
- Thermal and Short-Circuit Protection with Auto Recovery
- Built-in Pop-and-click noise suppression
- Low RF Susceptibility
- Available in 1.57mmX1.61mm 14-ball WLCSP Package

Applications

- Mobile Phones and Tablets
- Portable Media Players

Simplified Application Diagram

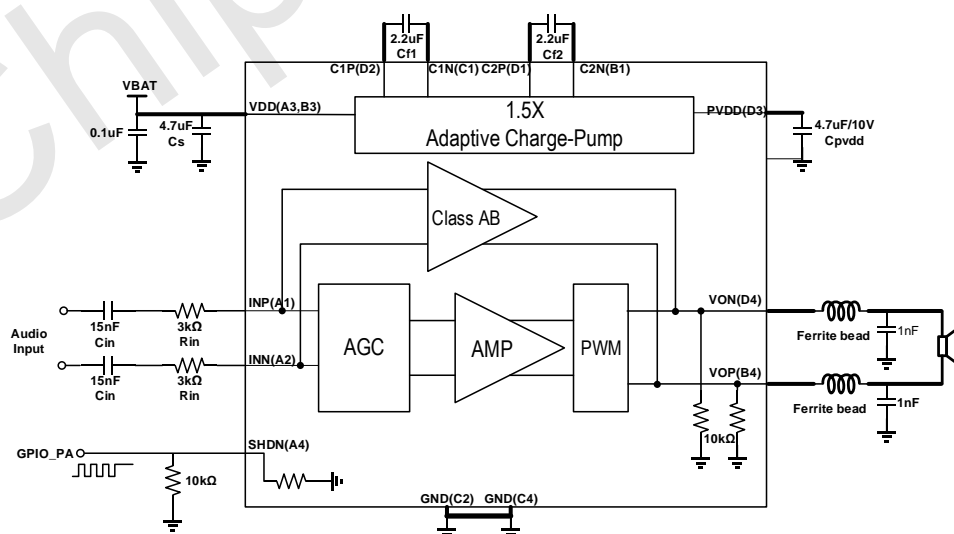



Adaptive Charge-Pump, Receiver-Mode Class G Audio Amplifier

Pin Configuration

HAA9007 TOP VIEW

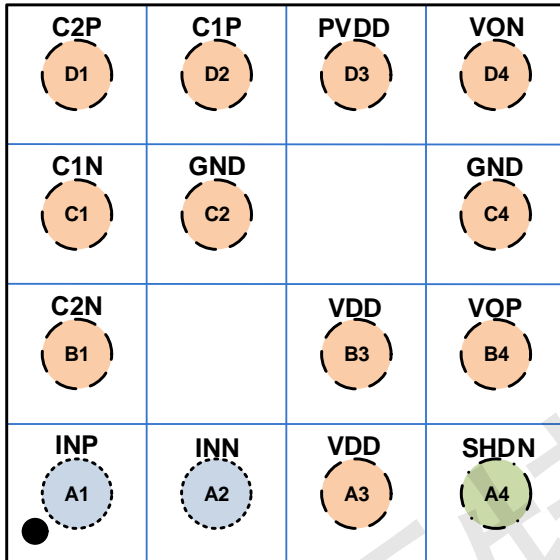

Pin Functions

PIN No.	PIN Name	Description
A1	INP	Positive audio input of the Class G Audio Amplifier
A2	INN	Negative audio input of the Class G Audio Amplifier
A3、B3	VDD	Supply voltage
A4	SHDN	Single wire Pulse Control Terminal
B1	C2N	Charge-Pump Flying Capacitor Terminal
B4	VOP	Positive PWM audio Output of the Class G Audio Amplifier
C1	C1N	Charge-Pump Flying Capacitor Terminal
C2,C4	GND	Ground
D1	C2P	Charge-Pump Flying Capacitor Terminal
D2	C1P	Charge-Pump Flying Capacitor Terminal
D3	PVDD	Audio power stage supply voltage
D4	VON	Negative PWM audio Output of the Class G Audio Amplifier

Order Information

Part No.	Package	Mark	Tape and Reel Information
HAA9007	CSP14L	9007 XXXXXX	3000/Reel



Adaptive Charge-Pump, Receiver-Mode Class G Audio Amplifier

Absolute Maximum Ratings

Over operating free-air temperature range, TA= 25°C (unless otherwise noted)⁽¹⁾

Parameter		Min	Max	Unit
Supply Voltage	VDD	-0.3	5.5	V
Input Voltage	INP,INN,SHDN	-0.3	VDD+0.3	V
Operating free-air temperature range T _A		-40	85	°C
Operating junction temperature range T _J		-40	150	°C
Storage temperature range T _{STG}		-65	150	°C
Minimum load impedance		3		Ω
Human Body Model (HBM) ESD ⁽²⁾		2000		V
Thermal Metric				
θ _{JA}	14-ball WLCSP 1.57x1.61mm	70		°C/W

(1) Stresses beyond those listed under absolute maximum ratings may cause permanent damage to the device. These are stress ratings only, and functional operation of the device at these or any other conditions beyond those indicated under recommended operating conditions is not implied. Exposure to absolute-maximum-rated conditions for extended periods may affect device reliability.

(2) This device series contains ESD protection and passes the following tests:

Human Body Model (HBM) standard: MIL-STD-883J/Method 3015.8 for all pins.

Charged devices and circuit boards can discharge without detection. Although this product features patented or proprietary protection circuitry, damage may occur on devices subjected to high energy ESD. Therefore, proper ESD precautions should be taken to avoid performance degradation or loss of functionality.



Adaptive Charge-Pump, Receiver-Mode Class G Audio Amplifier

Operating Control Description

Single Wire Pulse Control timing sequence

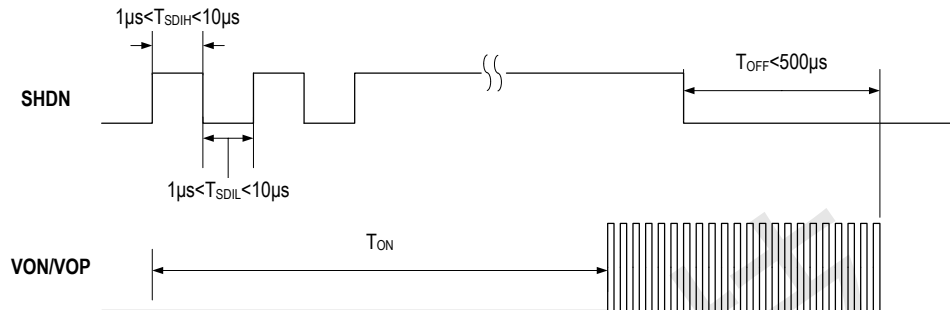

Operation Mode Description

SHDN Signal	Mode	Description
Control signal of SHDN PIN	Mode 1	AGC ON , 1.2W(8Ω) Output Power Control
Mode1	Mode 2	AGC ON , 1.0W(8Ω) Output Power Control
Mode2	Mode 3	AGC ON , 0.8W(8Ω) Output Power Control
Mode3	Mode 4	AGC ON , 0.6W (8Ω)Output Power Control
Mode4	Mode 5	Class AB Receiver Mode, Gain=1V/V
Mode5	Mode6	Class AB Receiver Mode, Gain=3V/V
Mode6	Mode7	AGC OFF
Mode7		



Adaptive Charge-Pump, Receiver-Mode Class G Audio Amplifier

Electrical Characteristics

VDD=3.6V, TA = 25°C, RL = 8Ω+33μH, Rin = 3kΩ, Cin = 1μF (unless otherwise noted)

Parameter	Symbol	Conditions	Min	Typ	Max	Unit
Supply Voltage Range	VDD		3		5	V
Shutdown Current	ISD			0.1	1	μA
Turn Off Time	TOFF		100		500	μs
Over Temp Protection	TOVP			155		°C
Single wire pulse (SHDN PIN)						
High-level Input Voltage	VSDIH		1.3		VDD	V
Low-level Input Voltage	VSDIL		0		0.35	V
High-level Duration	TSDIH		1		10	μs
Low-level Duration	TSDIL		1		10	μs
Single wire pulse (SEL PIN)						
High-level Input Voltage	VSEL		1.3		VDD	V
Low-level Input Voltage	VSEL		0		0.35	V
Charge-Pump(CP) Boost Converter						
Active Threshold	VAT			0.7		V
Over Voltage Production	VOVP		5.7	6	6.3	V
Output Regulation Voltage	PVDDS	VOP-VON _{peak} < VAT		VDD		V
		VOP-VON _{peak} > VAT, VDD*1.5 < VOVP		1.5*VDD		V
		VOP-VON _{peak} > VAT VDD*1.5 > VOVP		VOVP		V
Switching Frequency	F _{CP}			1.06		MHz
CP ON Resistance	R _{ONCP}	VDD = 3.8V, I _{out} = 0.9A		1.2		Ω
Class D Power Amplifier						
Operating Quiescent Current	I _Q	Input AC Ground		3.6		mA
Turn-on Time	T _{ON}			41.		ms
Output Offset Voltage	V _{OS}	Input AC Ground	-20		20	mV
Switching Frequency	F _{PA}			800		kHz
Voltage Gain	A _v			16.6		V/V
Input Impedance	R _{IN}	Speaker Mode		16.6		kΩ
Frequency Response of Gain		BW = 20Hz to 20kHz	-0.3		0.3	dB
Output Noise Voltage	V _N	Rin = 3kΩ, Cin = 33nF, Gain =16, A-weighted		65		μVrms
		Rin = 23kΩ, Cin = 33nF, Gain=8, A-weighted		48		
Output Impedance in SD	Z _O	SHDN = GND		10k		Ω
Total Harmonic Distortion Plus Noise	THD+N	VDD = 3.8V, P _O = 0.3W, RL= 8Ω+33μH, Mode7		0.012		%
		VDD = 3.8V, P _O = 0.8W, RL= 8Ω+33μH, Mode7		0.01		
		VDD = 3.8V, P _O = 1.2W, RL= 8Ω+33μH, Mode7		0.011		
Class G + CP Efficiency	η	VDD = 4.2V, P _O = 1 W, RL= 8Ω+33μH		79		%
		VDD = 3.8V, P _O = 0.8 W, RL= 8Ω+33μH		81		



Adaptive Charge-Pump, Receiver-Mode Class G Audio Amplifier

		$V_{DD} = 3.3V, P_O = 0.6W, R_L = 8\Omega + 33\mu H$		80		
Power Supply Ripple Rejection	PSRR	Input AC Ground, $V_{ripple} = 200mV_{pp}$,	217Hz	-74		dB
			1kHz	-70		
			10kHz	-56		
Output Power	P_O	$V_{DD} = 4.2V, THD+N = 1\%, R_L = 8\Omega + 33\mu H$		1.765		W
		$V_{DD} = 3.8V, THD+N = 1\%, R_L = 8\Omega + 33\mu H$		1.42		
		$V_{DD} = 3.3V, THD+N = 1\%, R_L = 8\Omega + 33\mu H$		1.05		
		$V_{DD} = 4.2V, THD+N = 10\%, R_L = 8\Omega + 33\mu H$		2.181		
		$V_{DD} = 3.8V, THD+N = 10\%, R_L = 8\Omega + 33\mu H$		1.743		
		$V_{DD} = 3.3V, THD+N = 10\%, R_L = 8\Omega + 33\mu H$		1.28		
		$V_{DD} = 4.2V, THD+N = 1\%, R_L = 4\Omega + 33\mu H$		2.351		
		$V_{DD} = 4.2V, THD+N = 10\%, R_L = 4\Omega + 33\mu H$		2.765		
		$V_{DD} = 4.2V, THD+N = 1\%, R_L = 3\Omega + 33\mu H$		2.31		
		$V_{DD} = 4.2V, THD+N = 10\%, R_L = 3\Omega + 33\mu H$		2.59		
AGC Output Power	P_O	Mode1, $R_L = 8\Omega + 33\mu H$		1.2		W
		Mode2, $R_L = 8\Omega + 33\mu H$		1		
		Mode3, $R_L = 8\Omega + 33\mu H$		0.8		
		Mode4, $R_L = 8\Omega + 33\mu H$		0.6		
AGC Attack Time	T_{ATK}			41		ms
AGC Release Time	T_{REL}			1.15		s
Max Attenuation Gain				-13.5		dB
Signal Noise Ratio	SNR	$V_{DD} = 3.8V, P_O = 1.42W, R_L = 8\Omega + 33\mu H$		98		dB

Class-AB Receiver Power Amplifier

Operating Quiescent Current	I_{QAB}	Input AC Ground, $V_{DD} = 3.6V$		3		mA
Turn-on Time	T_{ONAB}	Receiver Mode		41		ms
Output Offset Voltage	V_{OS}	Input AC Ground		-8	8	mV
Voltage Gain	A_V	Mode5		1		V/V
		Mode6		3		
Input Impedance	R_{INI}	Mode5		45k		Ω
		Mode6		45k		
Output Noise Voltage	V_N	$C_{IN} = 33nF, A$ -weighted, Mode5		8.5		μV_{rms}
		$C_{IN} = 33nF, A$ -weighted, Mode6		18.5		
Total Harmonic Distortion Plus Noise	THD+N	$V_{DD} = 4.2V, P_O = 10mW, R_L = 8\Omega, f = 1kHz$		0.21		%
		$V_{DD} = 4.2V, P_O = 50mW, R_L = 8\Omega, f = 1kHz$		0.15		%
		$V_{DD} = 4.2V, P_O = 100mW, R_L = 8\Omega, f = 1kHz$		0.12		%
Power Supply Ripple Rejection	PSRR	Mode5, Input AC Ground, $V_{ripple} = 200mV_{pp}, V_{DD} = 4.2V$	217Hz	-100		dB
			1kHz	-98		
Signal Noise Ratio	SNR	$V_{DD} = 3.8V, P_O = 100mW, R_L = 8\Omega + 33\mu H$		104		dB



Adaptive Charge-Pump, Receiver-Mode Class G Audio Amplifier

Typical Characteristics

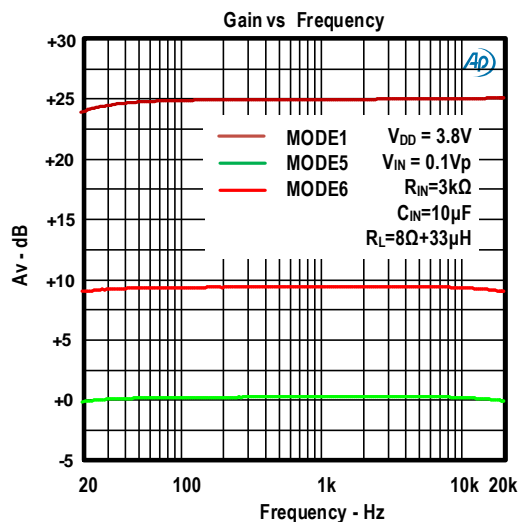
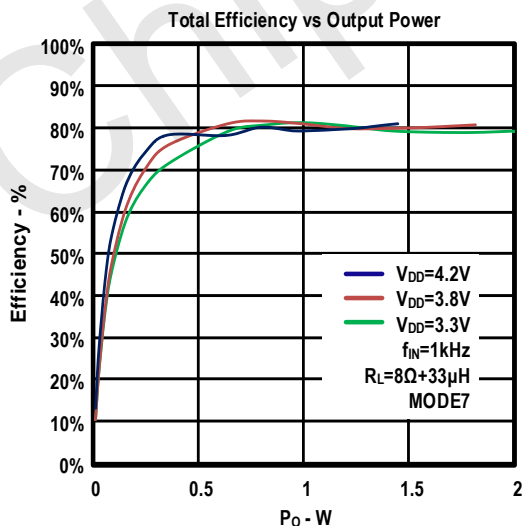
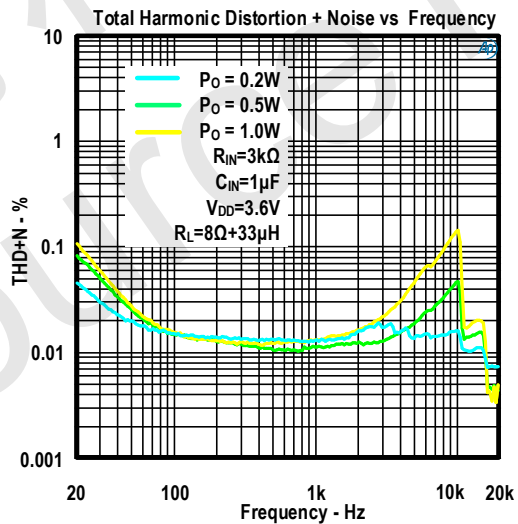
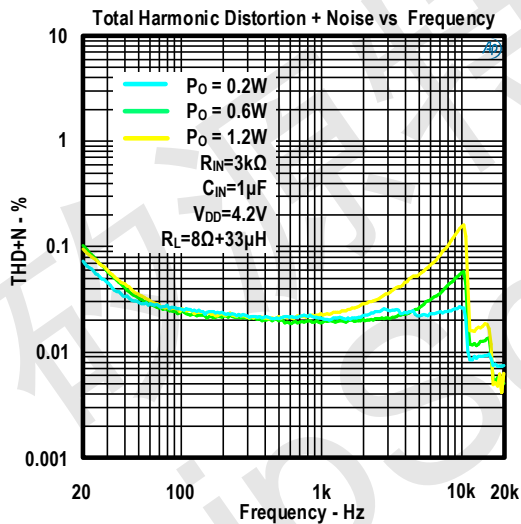
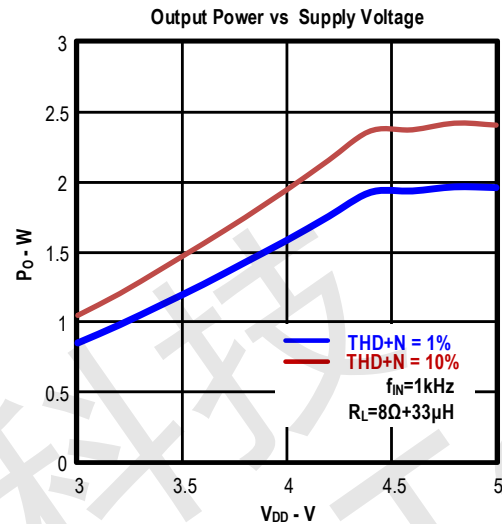
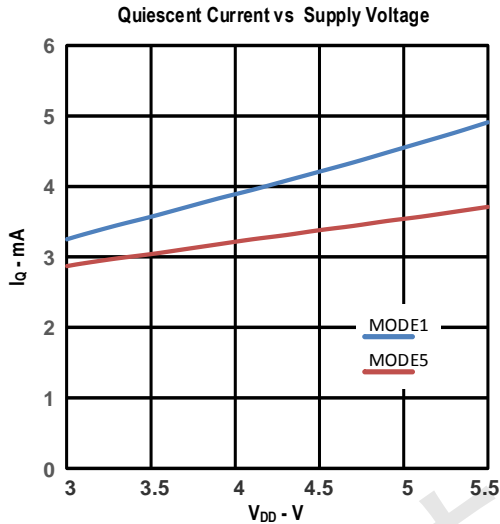



Adaptive Charge-Pump, Receiver-Mode Class G Audio Amplifier

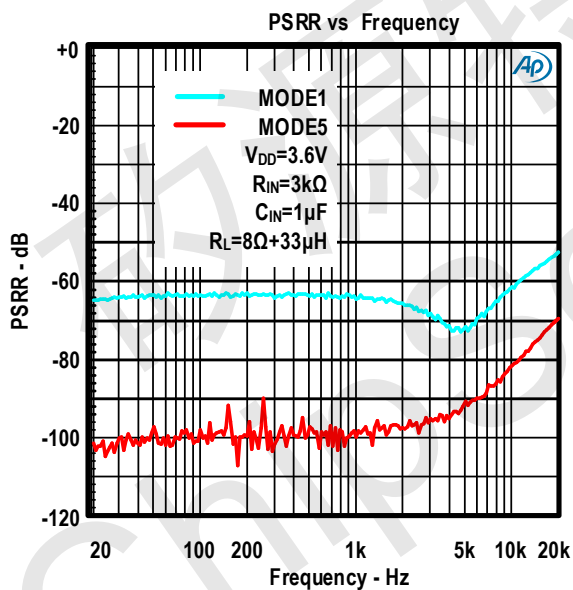
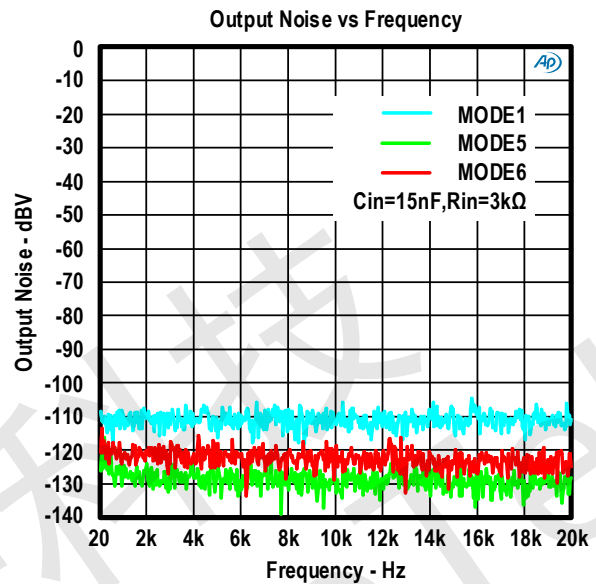
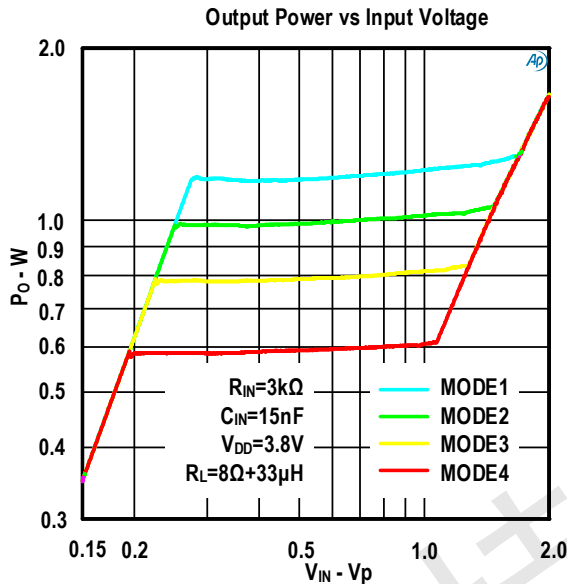



Adaptive Charge-Pump, Receiver-Mode Class G Audio Amplifier

Application Information

Decoupling Capacitor (C_s)

The HAA9007 is a high-performance Class-G audio amplifier that requires adequate power supply decoupling to ensure the efficiency is high and total harmonic distortion (THD) is low. For higher frequency transients, spikes, or digital hash on the line, a good low equivalent-series-resistance (ESR) 4.7μF ceramic capacitor placed as close as possible to the device V_{DD} pin works best. Placing this decoupling capacitor close to the HAA9007 is important for the efficiency of the Class-G amplifier, because any resistance or inductance in the trace between the device and the capacitor can cause a loss in efficiency. For filtering higher-frequency noise signals, a 0.1μF capacitor placed near the audio power amplifier would also help.

Charge Pump Flying Capacitor (C_{f1}, C_{f2})

The flying capacitor affects the load regulation and output impedance of the charge pump. The value of flying capacitor is too small results in a loss of current drive, leading to a loss of amplifier headroom. A higher valued flying capacitor improves load regulation and lowers charge pump output impedance to an extent. Selecting a 2.2μF/6.3V will help regarding the load regulation and the device's ability to provide sufficient current drive.

Charge Pump Hold Capacitor (C_{PVDD})

The value and ESR of the hold capacitor (C_{PVDD}) directly affects the ripple on C_{PVDD}. Increasing the value of C_{PVDD} reduces output ripple. Decreasing the ESR of C_{PVDD} reduces both output ripple and charge pump output impedance. A 4.7μF/10V capacitor is recommended.

Beam Filters

A ferrite bead filter can often be used if the design is failing radiated emissions without an LC filter and the frequency sensitive circuit is greater than 1MHz. This filter functions well for circuits that just have to pass FCC and CE because FCC and CE only test radiated emissions greater than 30MHz. When choosing a ferrite bead, choose one with high impedance at high frequencies, and low impedance at low frequencies. In addition, select a ferrite bead with adequate current rating to prevent distortion of the output signal. Use an LC output filter if there are low frequency (<1MHz) EMI sensitive circuits and/or there are long leads from amplifier to speaker. When use filter, it should be placed as close as possible to the device VOP/VON pin.

Input Resistors (R_{IN})

The HAA9007 has internal input resistors of 16.6kΩ. The input resistors set the gain of the amplifier according to equation below.

$$\text{Gain} = \frac{320\text{k}\Omega}{R_{\text{IN}} + 16.6\text{k}\Omega}$$

Place the input resistors very close to INN/INP pin to limit noise injection on the high-impedance nodes.

Input Capacitors (C_{IN})

The input capacitors and input resistors form a high-pass filter with the corner frequency f_o, determined in equation below.

$$f_o = \frac{1}{2\pi * C_{\text{IN}} * (R_{\text{IN}} + 16.6\text{k}\Omega)}$$

The value of the input capacitor is important to consider as it directly affects the bass (low frequency) performance of the circuit. Speakers in wireless phones cannot usually respond well to low frequencies, so the corner frequency can be set to block low frequencies in this application. If the corner frequency is within the audio band, the capacitors should have a tolerance of ±10% or better, because any mismatch in capacitance causes an impedance mismatch at the corner frequency and below, it may cause turn-on pop noise.



Adaptive Charge-Pump, Receiver-Mode Class G Audio Amplifier

Package Outline

1.57mmX1.61mm 14-ball WLCSP Package

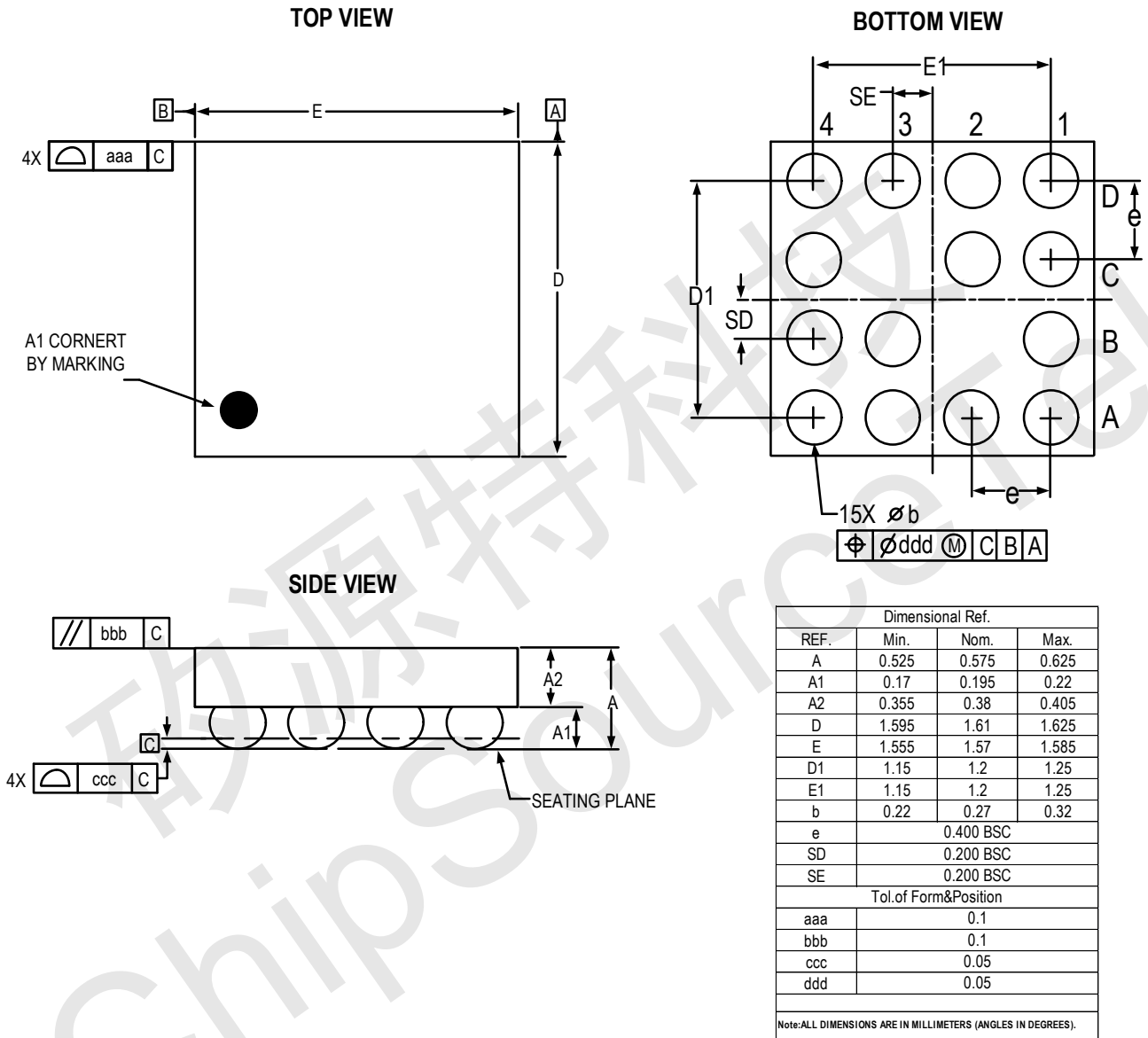

All rights reserved. Reproduction in whole or in part is prohibited without the prior written consent of the copyright owner. The information presented in this document does not form part of any quotation or contract, is believed to be accurate and reliable and may be changed without notice. No liability will be accepted by the publisher for any consequence of its use. Publication thereof does not convey nor imply any license under patent or other industrial or intellectual property rights.