

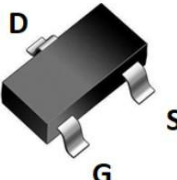



JMTL2N7002KS

Description

JMT N-channel MOSFET		
<p>Features</p> <ul style="list-style-type: none"> • $V_{DS}=60V$, $I_D=0.25A$ • $R_{DS(ON)} < 2.2\Omega @ V_{GS} = 10V$ • $R_{DS(ON)} < 2.87\Omega @ V_{GS} = 5V$ • Advanced Trench Technology • Excellent $R_{DS(ON)}$ and Low Gate Charge • Lead free product is acquired • ESD Protected: 2KV 	<p>Application</p> <ul style="list-style-type: none"> • Battery Operated Systems • Direct logic-level Interface: TTL/CMOS • Solid-State Relays 	
 <p>SOT-23 top view</p>	 <p>Marking and pin Assignment</p>	 <p>Schematic diagram</p>

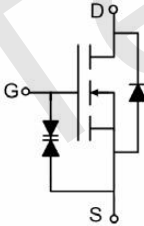
Package Marking and Ordering Information

Device Marking	Device	OUTLINE	Device Package	Reel Size	Reel (PCS)	Per Carton (PCS)
72K	JMTL2N7002KS	TAPING	SOT-23	7inch	3000	180000

Absolute Maximum Ratings ($T_A=25^\circ C$ unless otherwise specified)

Symbol	Parameter	Max.	Units
V_{DSS}	Drain-Source Voltage	60	V
V_{GSS}	Gate-Source Voltage	± 20	V
I_D	Continuous Drain Current	$T_A = 25^\circ C$	0.25
		$T_A = 100^\circ C$	0.16
I_{DM}	Pulsed Drain Current ^{note1}	1	A
P_D	Power Dissipation	$T_A = 25^\circ C$	0.23
$R_{\theta JA}$	Thermal Resistance, Junction to Ambient	543	$^\circ C/W$
T_J, T_{STG}	Operating and Storage Temperature Range	-55 to +150	$^\circ C$



JMTL2N7002KS

Electrical Characteristics (T_J=25°C unless otherwise specified)

Symbol	Parameter	Test Condition	Min.	Typ.	Max.	Units
Off Characteristic						
V _{(BR)DSS}	Drain-Source Breakdown Voltage	V _{GS} =0V, I _D = 250μA	60	-	-	V
I _{DSS}	Zero Gate Voltage Drain Current	V _{DS} =60V, V _{GS} = 0V,	-	-	1	μA
I _{GSS}	Gate to Body Leakage Current	V _{DS} =0V, V _{GS} = ±20V	-	-	±10	uA
On Characteristics						
V _{GS(th)}	Gate Threshold Voltage	V _{DS} = V _{GS} , I _D = 250μA	1	1.6	2.5	V
R _{DS(on)}	Static Drain-Source on-Resistance <small>note2</small>	V _{GS} =10V, I _D =0.3A	-	1.69	2.2	Ω
		V _{GS} =4.5V, I _D =0.2A	-	2.05	2.87	
Dynamic Characteristics						
C _{iss}	Input Capacitance	V _{DS} = 25V, V _{GS} = 0V, f = 1.0MHz	-	28	-	pF
C _{oss}	Output Capacitance		-	11	-	pF
C _{rss}	Reverse Transfer Capacitance		-	4	-	pF
Q _g	Total Gate Charge	V _{DS} = 10V, I _D = 0.3A, V _{GS} = 4.5V	-	1.7	-	nC
Q _{gs}	Gate-Source Charge		-	0.3	-	nC
Q _{gd}	Gate-Drain("Miller") Charge		-	0.6	-	nC
Switching Characteristics						
t _{d(on)}	Turn-on Delay Time	V _{DD} = 30V, I _D =0.2A, R _{GEN} = 10Ω, V _{GS} =10V,	-	10	-	ns
t _r	Turn-on Rise Time		-	50	-	ns
t _{d(off)}	Turn-off Delay Time		-	17	-	ns
t _f	Turn-off Fall Time		-	10	-	ns
Drain-Source Diode Characteristics and Maximum Ratings						
I _S	Maximum Continuous Drain to Source Diode Forward Current		-	-	0.25	A
I _{SM}	Maximum Pulsed Drain to Source Diode Forward Current		-	-	1	A
V _{SD}	Drain to Source Diode Forward Voltage	V _{GS} = 0V, I _S =0.25A	-	-	1.2	V

Notes:1. Repetitive Rating: Pulse Width Limited by Maximum Junction Temperature

2. Pulse Test: Pulse Width≤300μs, Duty Cycle≤2%



JMTL2N7002KS

Typical Performance Characteristics

Figure 1: Output Characteristics

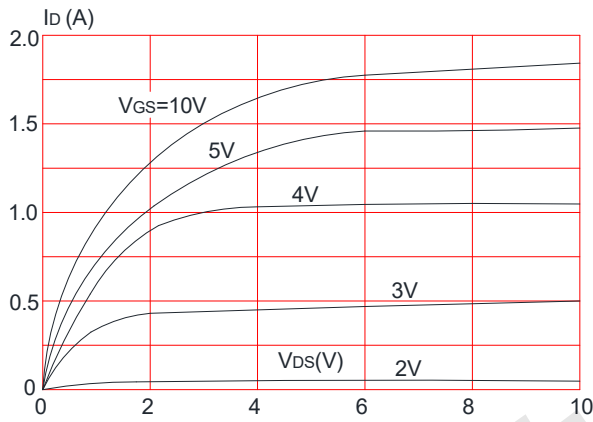

Figure 2: Typical Transfer Characteristics

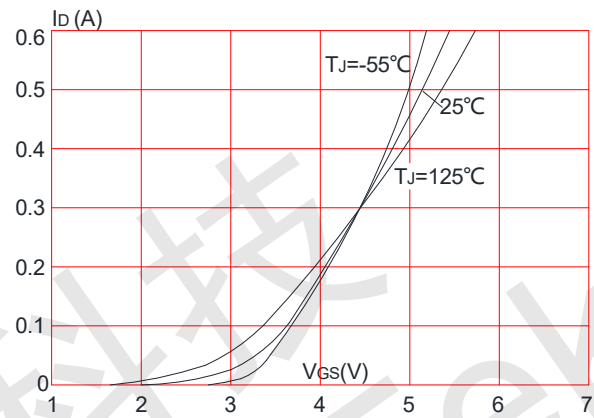

Figure 3: On-resistance vs. Drain Current

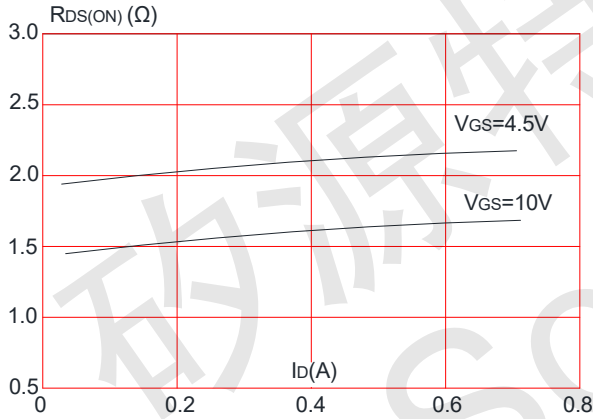

Figure 4: Body Diode Characteristics

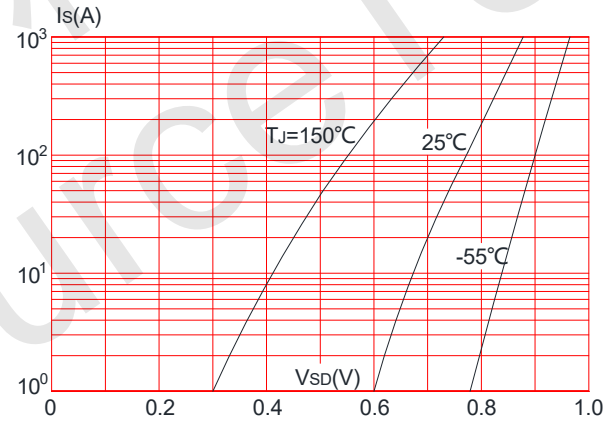

Figure 5: Gate Charge Characteristics

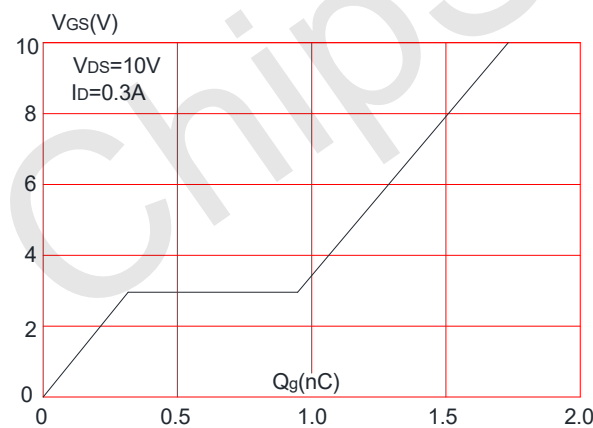
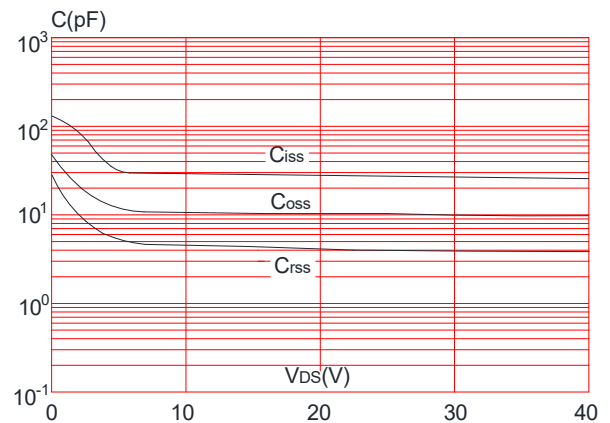

Figure 6: Capacitance Characteristics





JMTL2N7002KS

Figure 7: Normalized Breakdown Voltage vs. Junction Temperature

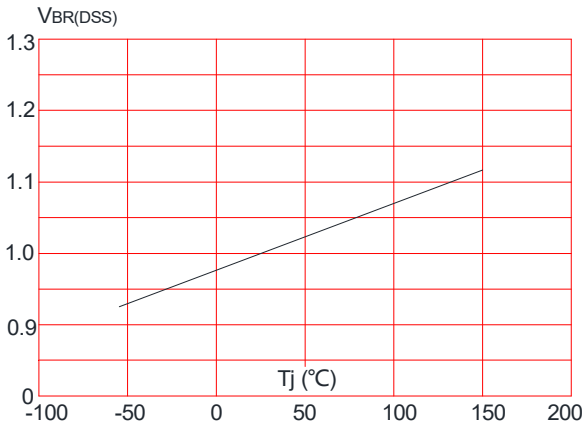

Figure 8: Normalized on Resistance vs. Junction Temperature

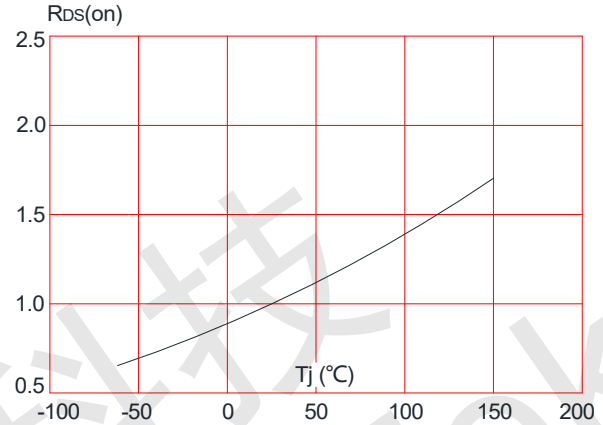

Figure 9: Maximum Safe Operating Area

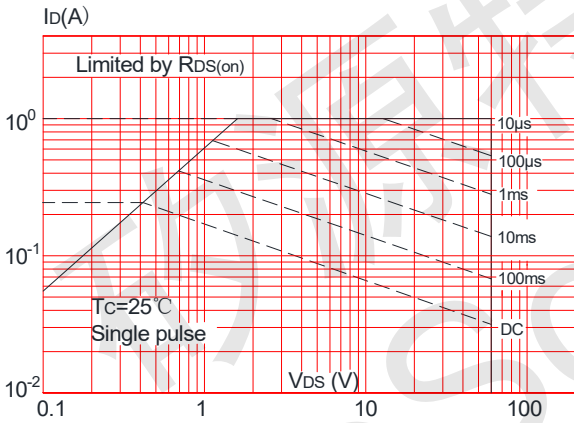

Figure 10: Maximum Continuous Drain Current vs. Case Temperature

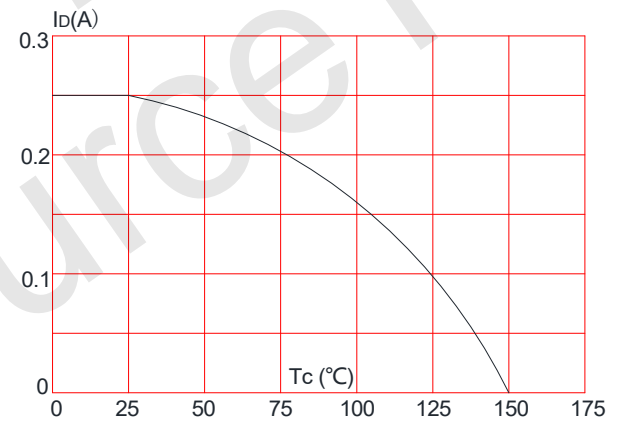
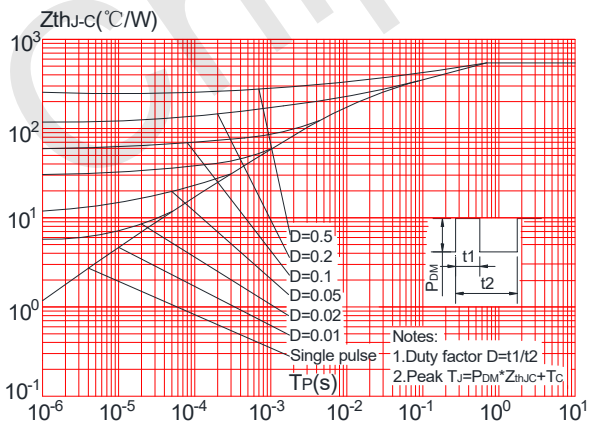

Figure.11: Maximum Effective Transient Thermal Impedance, Junction-to-Case





JMTL2N7002KS

Test Circuit

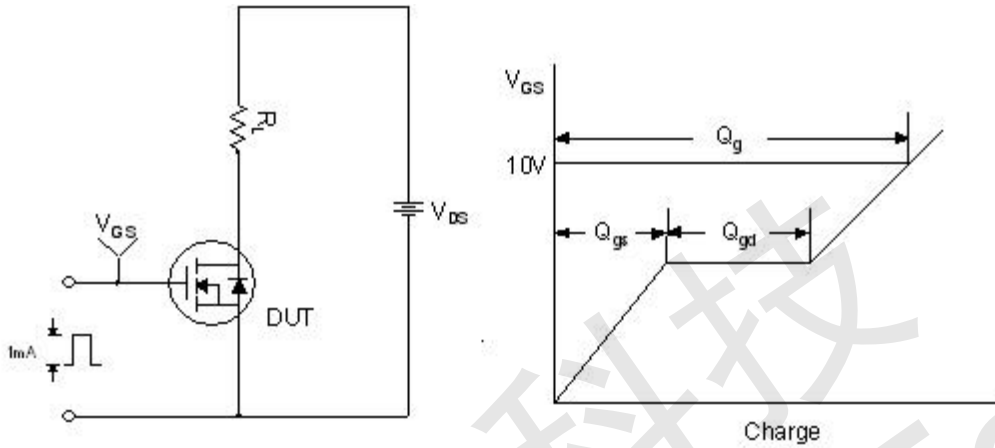

Figure 1. Gate Charge Test Circuit & Waveform

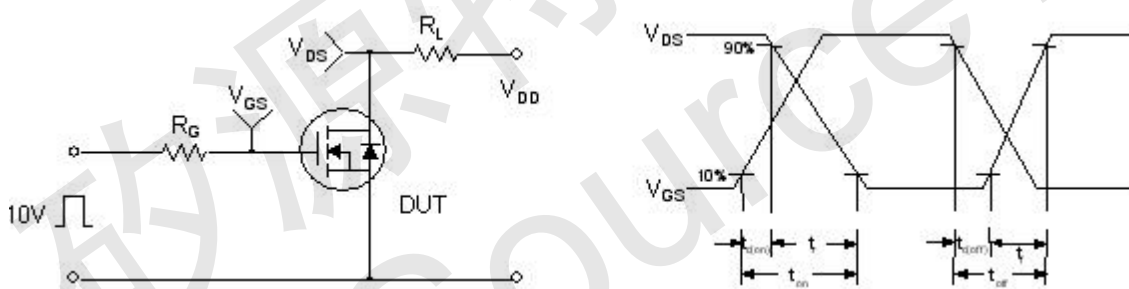

Figure 2. Resistive Switching Test Circuit & Waveforms

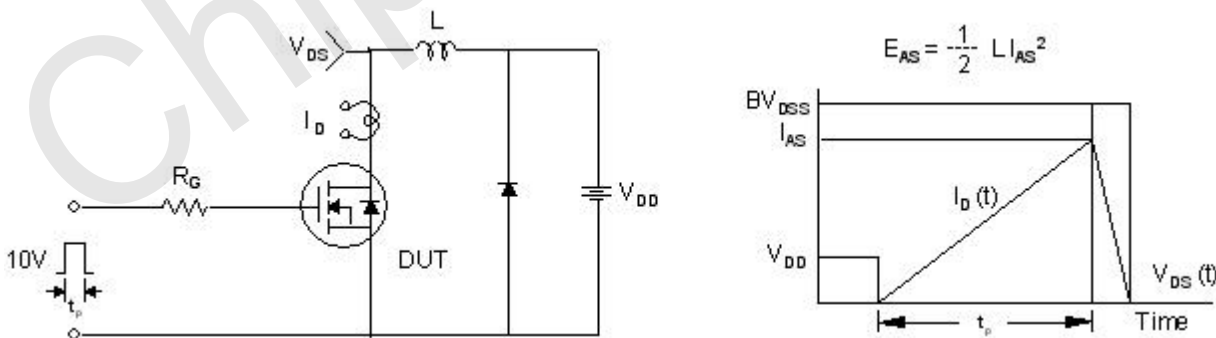
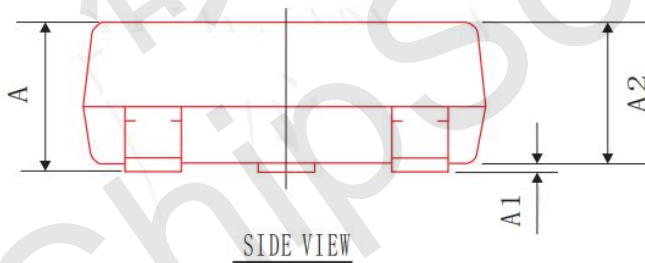
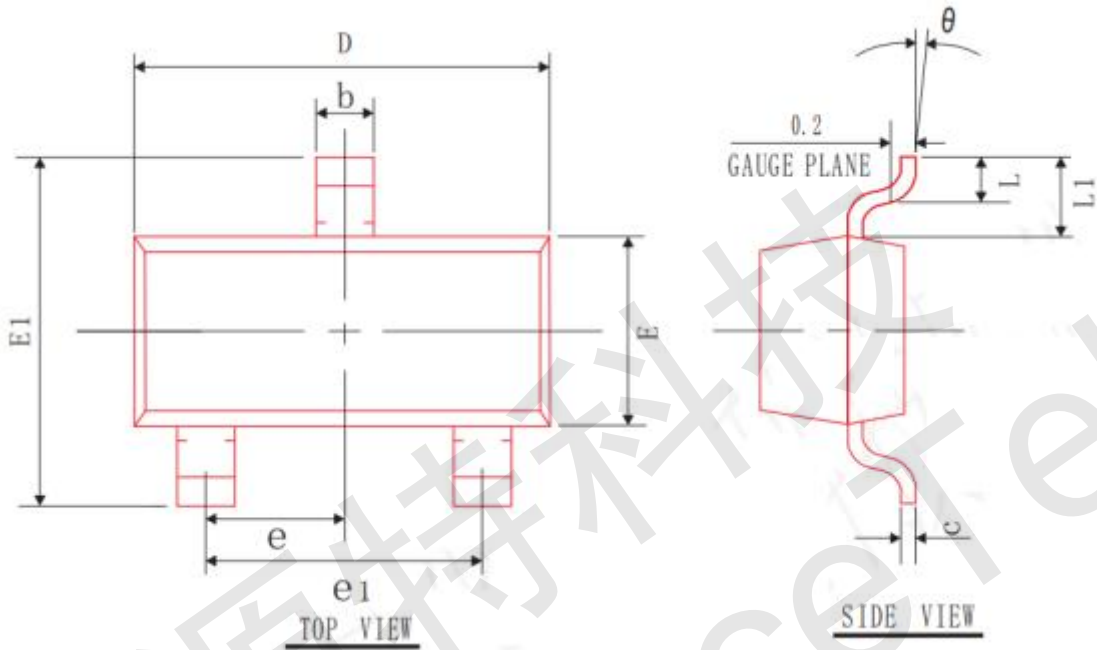

Figure 3. Unclamped Inductive Switching Test Circuit & Waveforms



JMTL2N7002KS

Package Mechanical Data



SYMBOL	MIN	NOM	MAX
A	0.90	1.05	1.20
A1	0.00	0.05	0.10
A2	0.90	1.00	1.10
b	0.30	0.40	0.50
c	0.08	0.10	0.15
D	2.80	2.90	3.00
E	1.20	1.30	1.40
E1	2.30	2.40	2.50
L	0.30	0.40	0.50
θ	0°	5°	10°
L1	0.55 REF		
e	0.95 BSC		
e ₁	1.90 REF		