

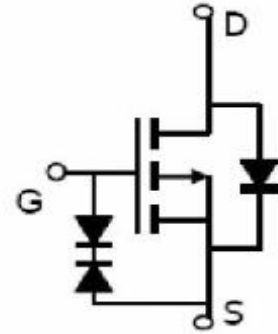

P-Channel Enhancement Mode Power MOSFET

Description

The MX2305 uses advanced trench technology to provide excellent RDS(ON), low gate charge and operation with gate voltages as low as 1.8V. This device is suitable for use as a load switch or in PWM applications .It is ESD protected.



General Features

- V_{DS} =-20V, I_D =-4A
- RDS(ON)(Typ.) < 38mΩ @ VGS=-4.5V
- RDS(ON) (Typ.)< 54mΩ @ VGS=-2.5V
- ESD Rating: 2500V HBM
- High Power and current handing capability
- Lead free product is acquired
- Surface mount package

Schematic diagram

Application

- ◆ PWM applications
- ◆ Load switch

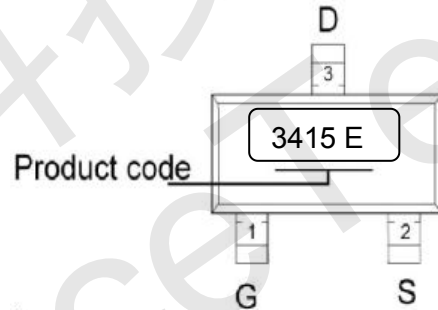

Marking and pin assignment
SOT-23-3 (TOP VIEW)

Absolute Maximum Ratings (TA=25°C unless otherwise noted)

Parameter	Symbol	Limit	Unit
Drain-Source Voltage	V _{DS}	-20	V
Gate-Source Voltage	V _{GS}	±10	V
Drain Current-Continuous	I _D	-4	A
Drain Current-Pulsed (Note 1)	I _{DM}	-25	A
Maximum Power Dissipation	P _D	1.4	W
Operating Junction and Storage Temperature Range	T _J , T _{STG}	-55 To 150	°C

Thermal Characteristic

Thermal Resistance,Junction-to-Ambient (Note 2)	R _{θJA}	89.3	°C/W
---	------------------	------	------



Electrical Characteristics (TA=25°C unless otherwise noted)

Parameter	Symbol	Condition	Min	Typ	Max	Unit
Off Characteristics						
Drain-Source Breakdown Voltage	BV _{DSS}	V _{GS} =0V, I _D =-250μA	-20	-23	-	V
Zero Gate Voltage Drain Current	I _{DSS}	V _{DS} =-20V, V _{GS} =0V	-	-	1	μA
Gate-Body Leakage Current	I _{GSS}	V _{GS} =±10V, V _{DS} =0V	-	-	±10	μA
On Characteristics (Note 3)						
Gate Threshold Voltage	V _{GS(th)}	V _{DS} =V _{GS} , I _D =-250μA	-0.4	-0.65	-1.0	V
Drain-Source On-State Resistance	R _{DS(on)}	V _{GS} =-4.5V, I _D =-4A	-	38	47	mΩ
		V _{GS} =-2.5V, I _D =-4A	-	54	60	mΩ
Forward Transconductance	g _{FS}	V _{DS} =-5V, I _D =-4A	8	-	-	S
Dynamic Characteristics (Note4)						
Input Capacitance	C _{iss}	V _{DS} =-10V, V _{GS} =0V, F=1.0MHz	-	890	-	PF
Output Capacitance	C _{oss}		-	160	-	PF
Reverse Transfer Capacitance	C _{rss}		-	125	-	PF
Switching Characteristics (Note 4)						
Turn-on Delay Time	t _{d(on)}	V _{DD} =-10V, R _L =2.5Ω V _{GS} =-4.5V, R _{GEN} =3Ω	-	15.6		nS
Turn-on Rise Time	t _r		-	11.2		nS
Turn-Off Delay Time	t _{d(off)}		-	23.1		nS
Turn-Off Fall Time	t _f		-	32.7		nS
Total Gate Charge	Q _g	V _{DS} =-10V, I _D =-4A, V _{GS} =-4.5V	-	14.2		nC
Gate-Source Charge	Q _{gs}		-	3.2	-	nC
Gate-Drain Charge	Q _{gd}		-	5.8	-	nC
Drain-Source Diode Characteristics						
Diode Forward Voltage (Note 3)	V _{SD}	V _{GS} =0V, I _S =-1A	-	-	-0.7	V
Diode Forward Current (Note 2)	I _S		-	-	-2.2	A

Notes:

- 1.Repetitive Rating: Pulse width limited by maximum junction temperature.
- 2.Surface Mounted on FR4 Board, t ≤ 10 sec.
- 3.Pulse Test: Pulse Width ≤ 300μs, Duty Cycle ≤ 2%.
- 4.Guaranteed by design, not subject to production



Typical Performance Characteristics

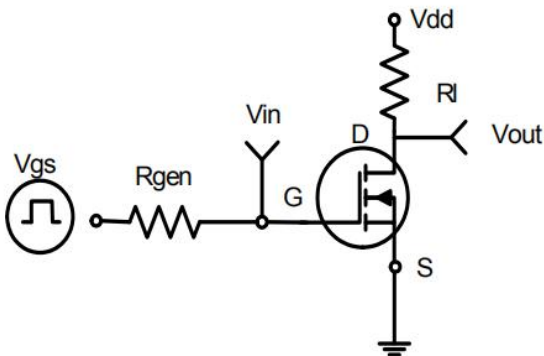

Figure 1: Switching Test Circuit

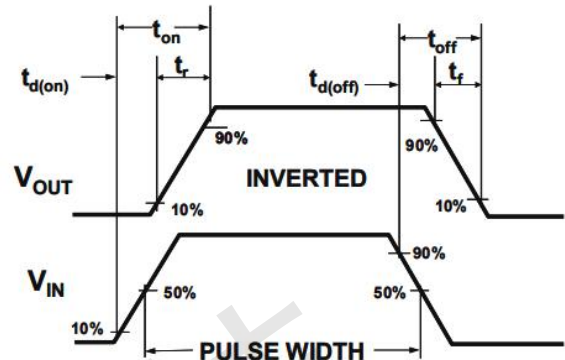

Figure 2: Switching Waveforms

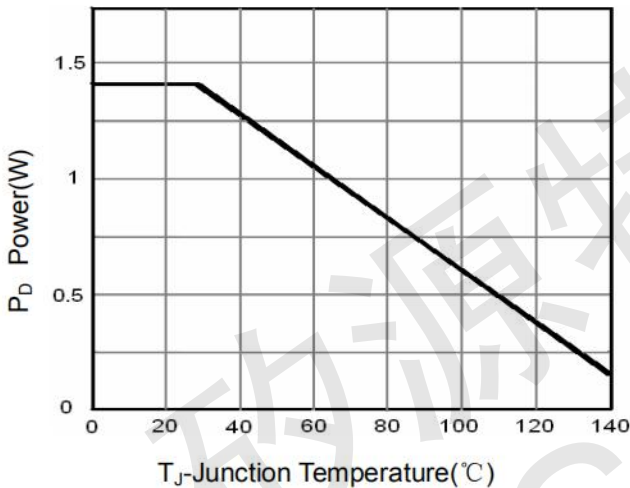

Figure 3 Power Dissipation

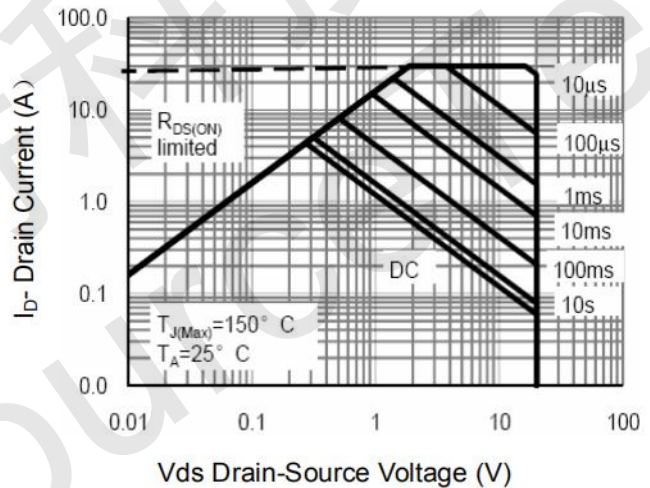

Figure 4 Safe Operation Area

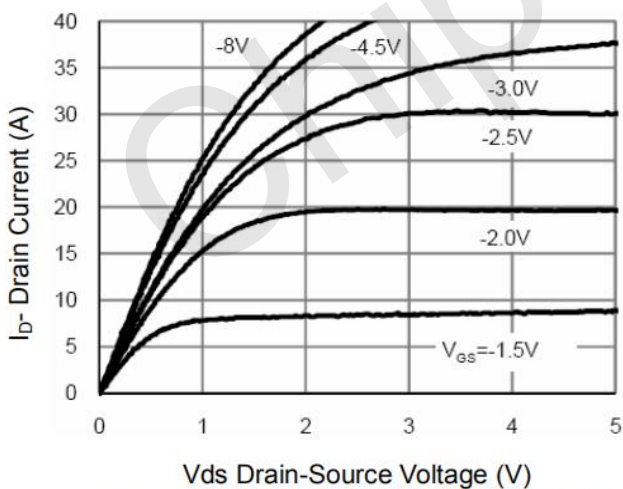

Figure 5 Output CHARACTERISTICS

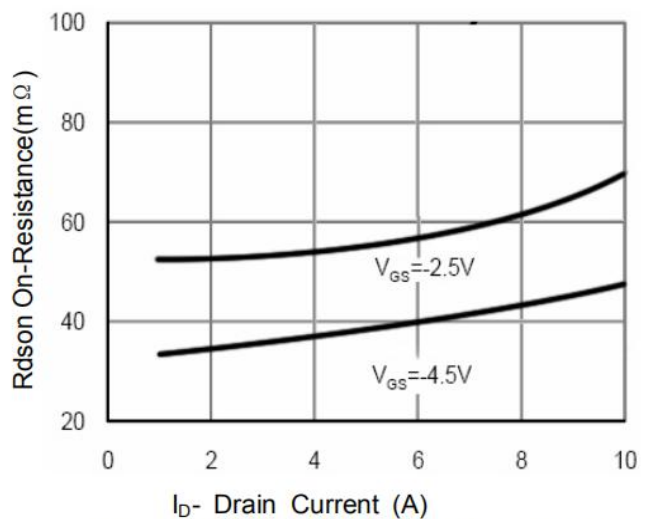

Figure 6 Drain-Source On-Resistance

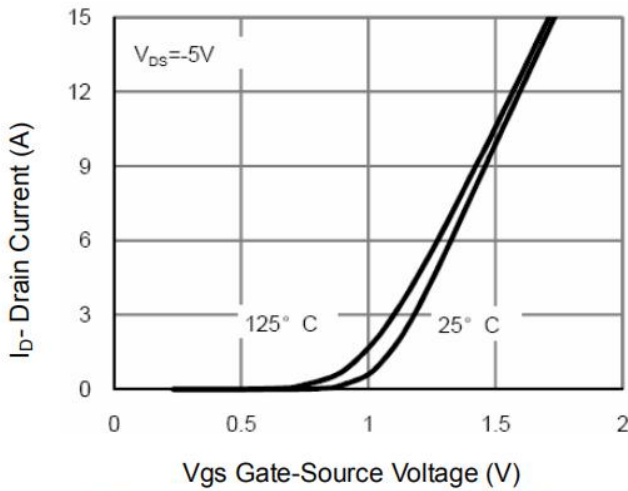

Figure 7 Transfer Characteristics

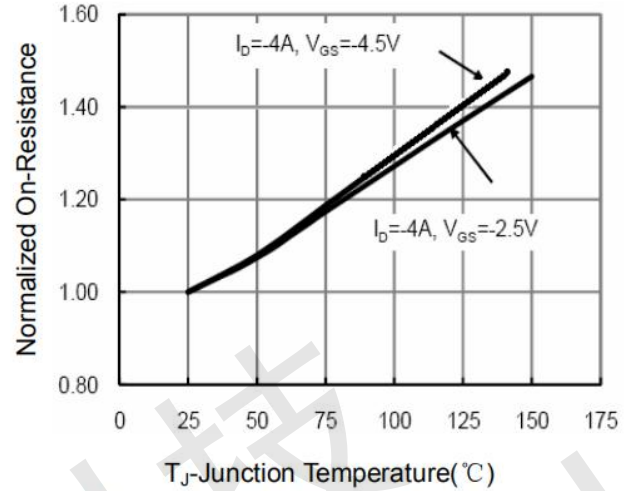

Figure 8 Drain-Source On-Resistance

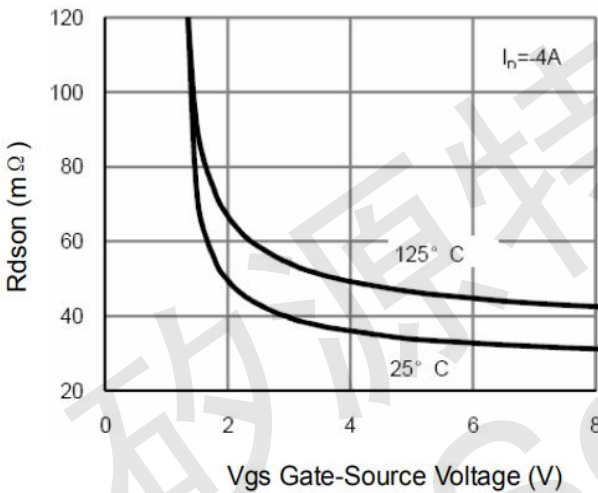

Figure 9 Rds vs Vgs

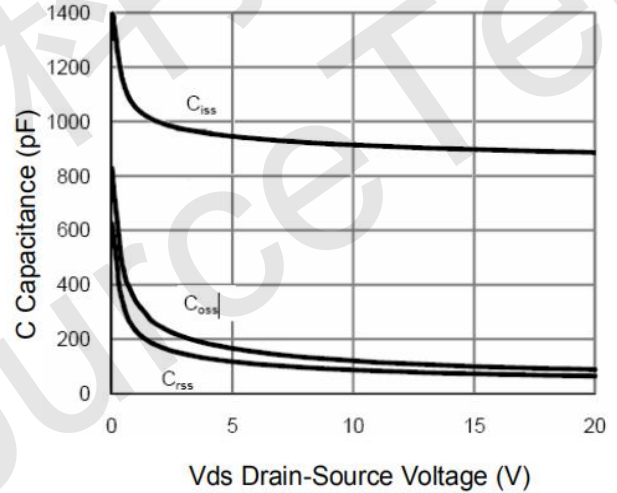

Figure 10 Capacitance vs Vds

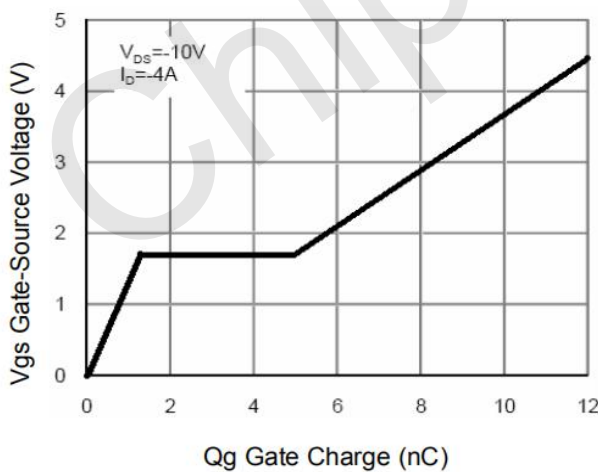

Figure 11 Gate Charge

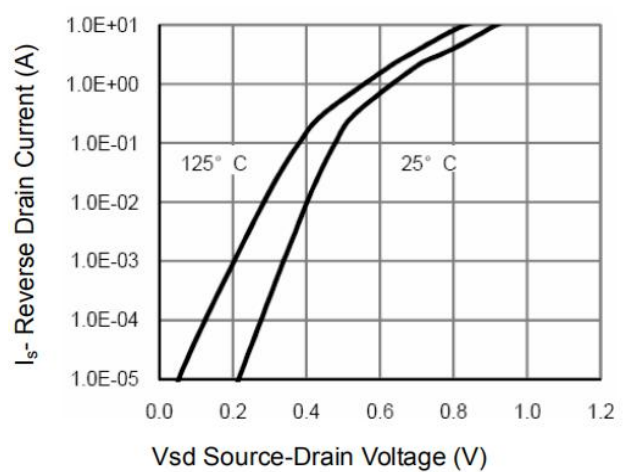

Figure 12 Source- Drain Diode Forward

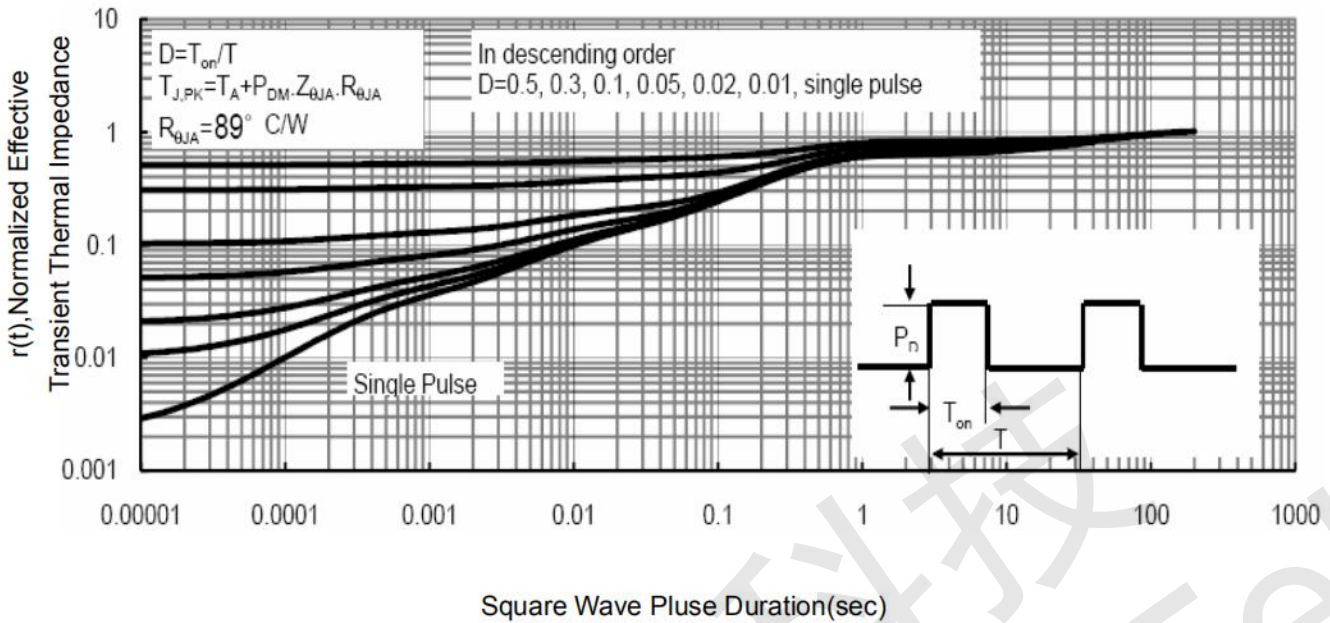
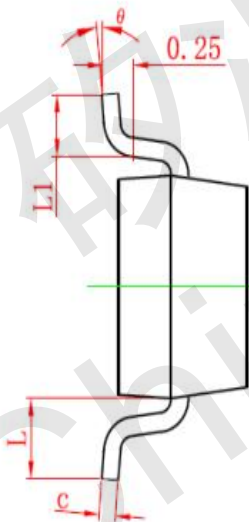
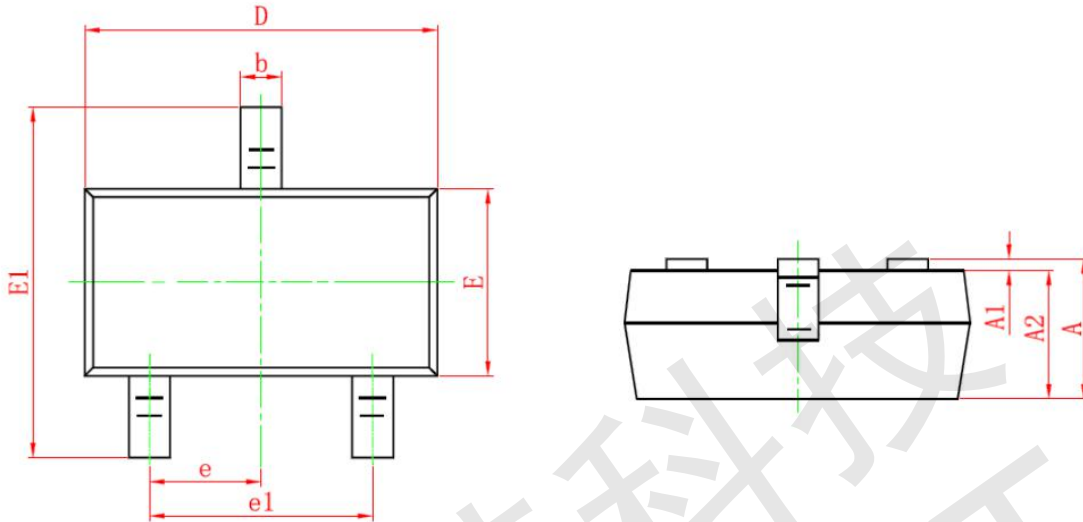

Figure 13 Normalized Maximum Transient Thermal Impedance



SOT23-3 PACKAGE INFOR



Symbol	Dimensions in Millimeters	
	MIN.	MAX.
A	0.900	1.150
A1	0.000	0.100
A2	0.900	1.050
b	0.300	0.500
c	0.080	0.150
D	2.800	3.000
E	1.200	1.400
E1	2.250	2.550
e	0.950TYP	
e1	1.800	2.000
L	0.550REF	
L1	0.300	0.500