



N-Channel Enhancement Mode Power MOSFET **MX2316**

DESCRIPTION

The MX2316 uses advanced trench technology to provide excellent $R_{DS(ON)}$, low gate charge and operation with gate voltages as low as 2.5V. This device is suitable for use as a battery protection or in other switching application.

GENERAL FEATURES

- $V_{DS}=20V$, $I_D=6A$
 $R_{DS(ON)}(Typ.)=21m\Omega$ @ $V_{GS}=2.5V$
 $R_{DS(ON)}(Typ.)=16m\Omega$ @ $V_{GS}=4.5V$
- High Power and current handling capability
- Lead free product is acquired
- Surface Mount Package

APPLICATION

- Battery protection
- Load switch
- Power management

PINOUT

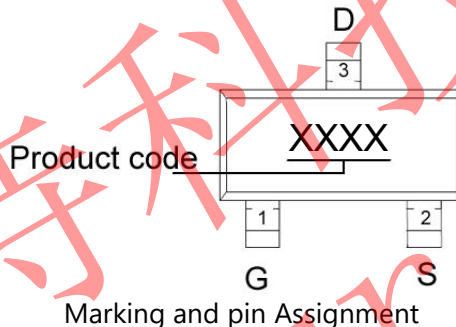
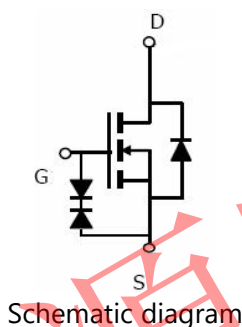

ORDERING INFORMATION

Part Number	Storage Temperature	Package	Devices Per Reel
MX2316	-55°C to 150°C	SOT-23	3000

ABSOLUTE MAXIMUM RATINGS ($T_A=25^\circ C$ unless otherwise noted)

Parameter	Symbol	Limit	Unit
Drain-Source Voltage	V_{DS}	20	V
Gate-Source Voltage	V_{GS}	± 10	V
Drain Current-Continuous	I_D	6.0	A
Drain Current-Continuous($T_A=70^\circ C$)	I_D	3.6	A
Pulsed Drain Current ^(Note1)	I_{DM}	15.0	A
Maximum Power Dissipation	P_D	1.25	W
Operating Junction and Storage Temperature Range	T_J, T_{STG}	-55 to 150	$^\circ C$

THERMAL RESISTANCE

Thermal Resistance, Junction-to-Ambient ^(Note2)	$R_{\theta JA}$	100	$^\circ C/W$
--	-----------------	-----	--------------

Note 1. Repetitive Rating: Pulse width limited by maximum junction temperature.

Note 2. Surface Mounted on FR4 Board, $t \leq 10$ sec.



N-Channel Enhancement Mode Power MOSFET **MX2316**



ELECTRICAL CHARACTERISTICS ($T_A=25^\circ\text{C}$ unless otherwise noted)

Parameter	Symbol	Conditions	Min	Typ	Max	Unit
Off Characteristics						
Drain-Source Breakdown Voltage	BV_{DSS}	$V_{GS}=0V, I_D=250\mu A$	20	22	-	V
Zero Gate Voltage Drain Current	I_{DSS}	$V_{DS}=20V, V_{GS}=0V$	-	-	1	μA
Gate-Body Leakage Current	I_{GSS}	$V_{GS}=\pm 10V, V_{DS}=0V$	-	-	± 10	μA
On Characteristics (Note 3)						
Gate Threshold Voltage	$V_{GS(th)}$	$V_{DS}=V_{GS}, I_D=250\mu A$	0.5	0.65	1.2	V
Drain-Source On-State Resistance	$R_{DS(ON)}$	$V_{GS}=2.5V, I_D=4A$	-	21	28	$m\Omega$
		$V_{GS}=4.5V, I_D=4.5A$	-	16	22	$m\Omega$
Forward Transconductance	g_{FS}	$V_{DS}=10V, I_D=4A$	-	10	-	S
Dynamic Characteristics (Note 4)						
Input Capacitance	C_{iss}	$V_{DS}=8V, V_{GS}=0V, F=1.0MHz$	-	500	-	pF
Output Capacitance	C_{oss}		-	300	-	pF
Reverse Transfer Capacitance	C_{rss}		-	140	-	pF
Switching Characteristics (Note 4)						
Turn-on Delay Time	$t_{d(on)}$	$V_{DD}=10V, I_D=1A, V_{GS}=4.5V, R_{GEN}=6\Omega$	-	20	40	nS
Turn-on Rise Time	t_r		-	18	40	nS
Turn-Off Delay Time	$t_{d(off)}$		-	60	108	nS
Turn-Off Fall Time	t_f		-	28	56	nS
Total Gate Charge	Q_g	$V_{DS}=10V, I_D=3A, V_{GS}=4.5V$	-	10	15	nC
Gate-Source Charge	Q_{gs}		-	2.3	-	nC
Gate-Drain Charge	Q_{gd}		-	2.9	-	nC
Drain-Source Diode Characteristics						
Diode Forward Voltage (Note 3)	V_{SD}	$V_{GS}=0V, I_S=1A$	-	-	1.2	V
Diode Forward Current (Note 2)	I_S		-	-	6.0	A

Note 2. Surface Mounted on FR4 Board, $t \leq 10$ sec.

Note 3. Pulse Test: Pulse Width $\leq 300\mu s$, Duty Cycle $\leq 2\%$.

Note 4. Guaranteed by design, not subject to product.



N-Channel Enhancement Mode Power MOSFET **MX2316**

TYPICAL ELECTRICAL AND THERMAL CHARACTERISTICS

Figure 1. Switching Test Circuit

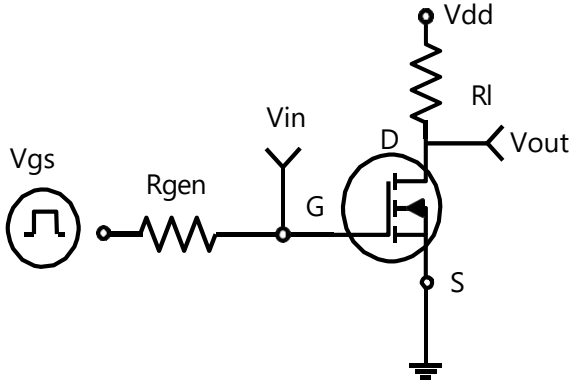

Figure 2. Switching Waveform

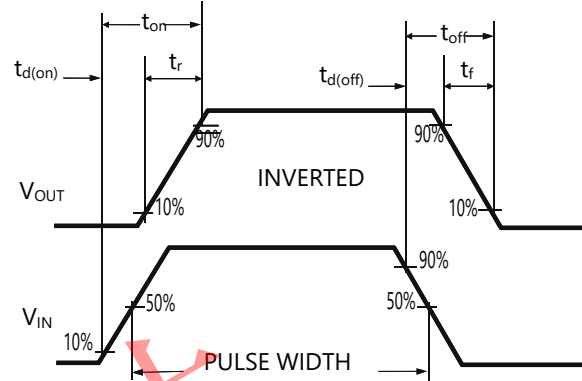

Figure 3. Power Dissipation

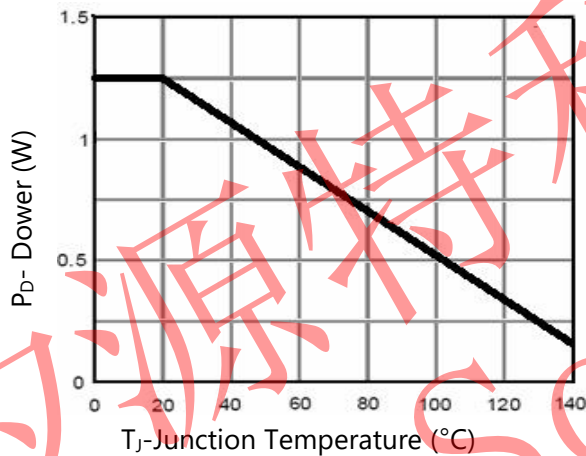

Figure 4. Drain Current

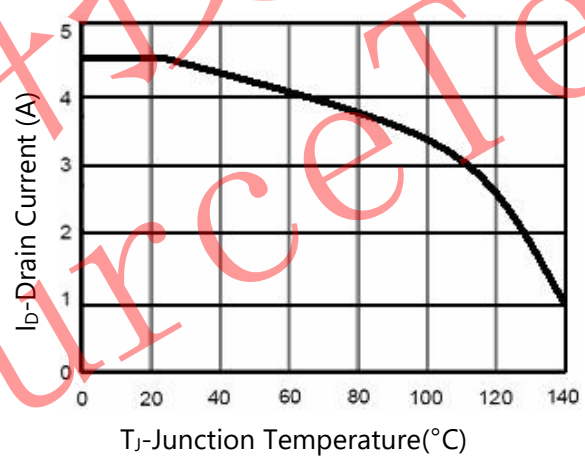

Figure 5. Output Characteristics

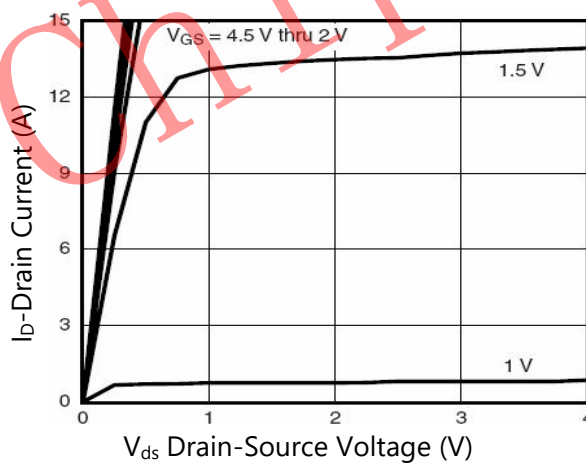
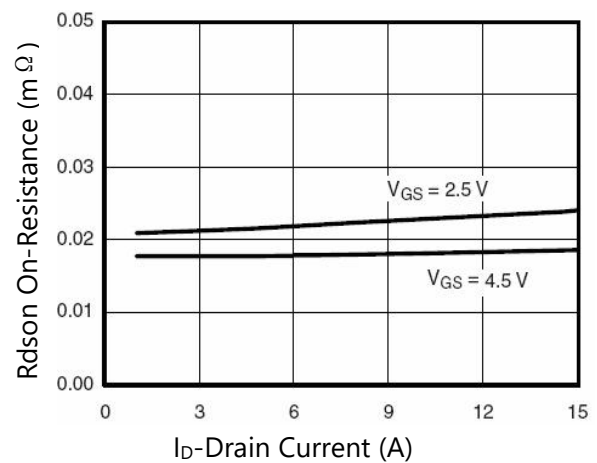

Figure 6. Drain-Source On-Resistance





N-Channel Enhancement Mode Power MOSFET **MX2316**

TYPICAL ELECTRICAL AND THERMAL CHARACTERISTICS

Figure 7. Transfer Characteristics

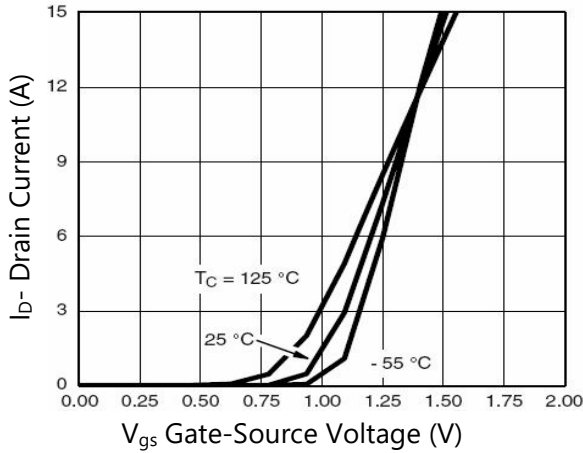

Figure 8. Drain-Source On-Resistance

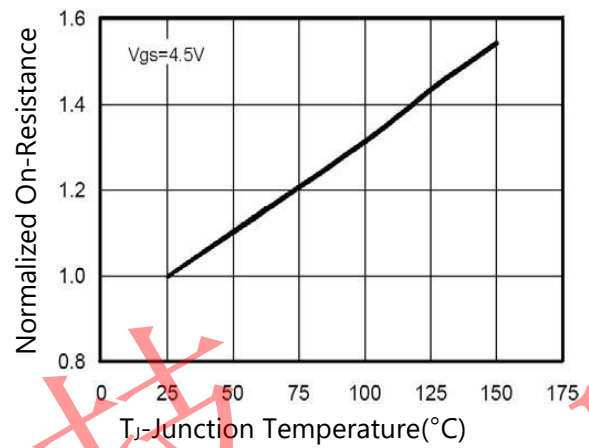

Figure 9. Rdson vs Vgs

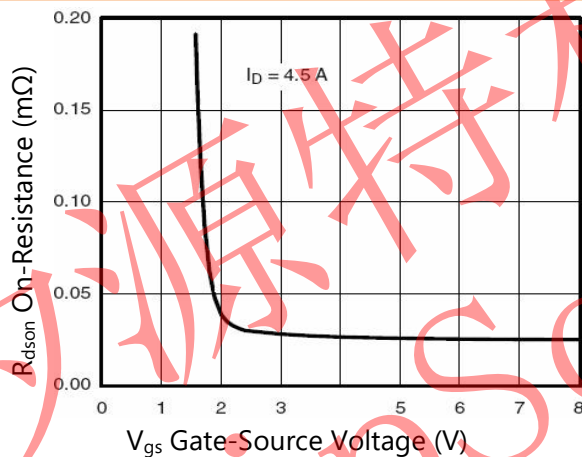

Figure 10. Capacitance vs Vds

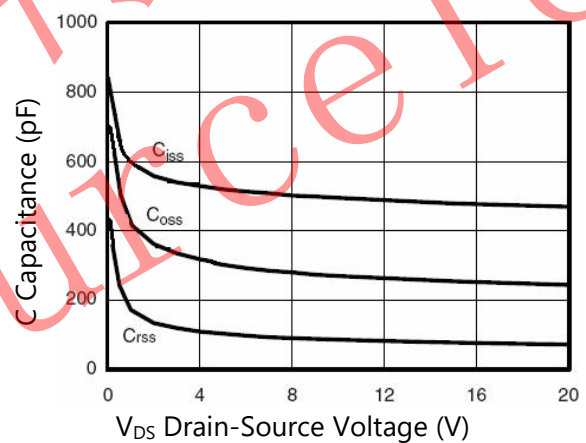

Figure 11. Gate Charge

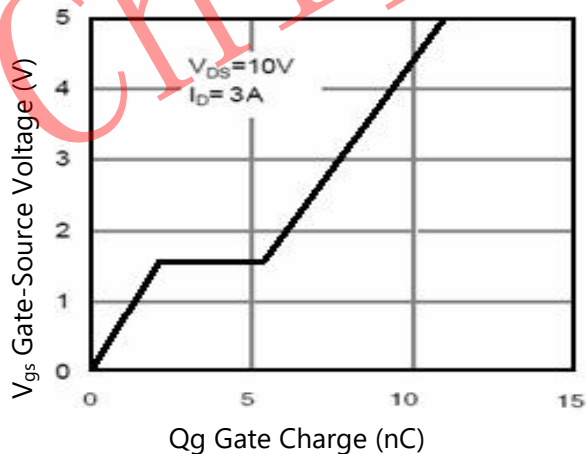
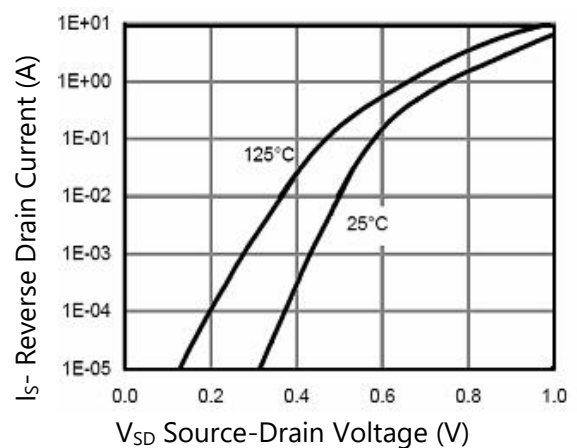

Figure 12. Source- Drain Diode Forward





N-Channel Enhancement Mode Power MOSFET **MX2316**

TYPICAL ELECTRICAL AND THERMAL CHARACTERISTICS

Figure 13. Safe Operation Area

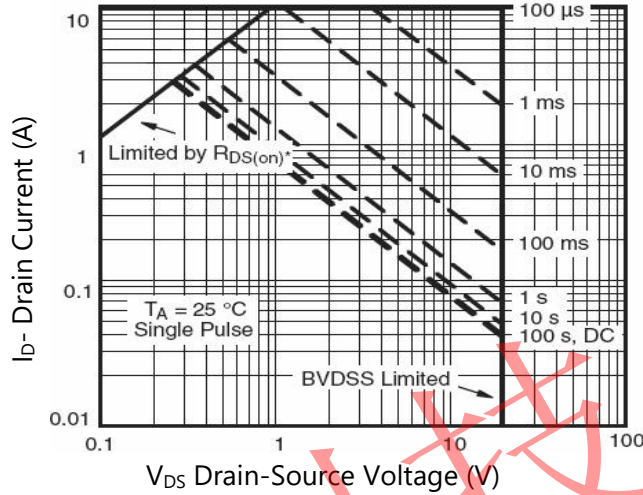
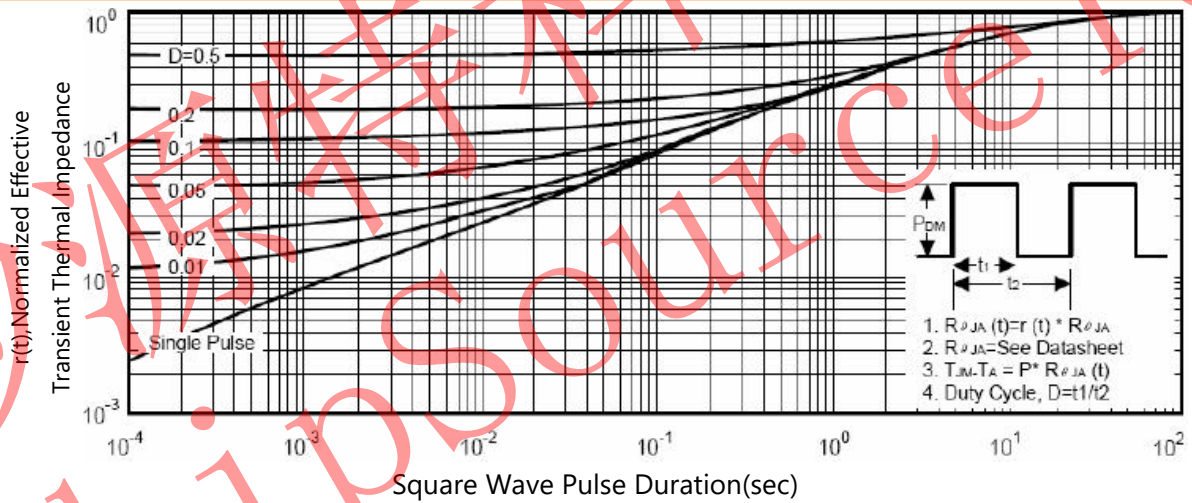

Figure 14. Normalized Maximum Transient Thermal Impedance





N-Channel Enhancement Mode Power MOSFET **MX2316**

 **PACKAGE INFORMATION**

SOT-23

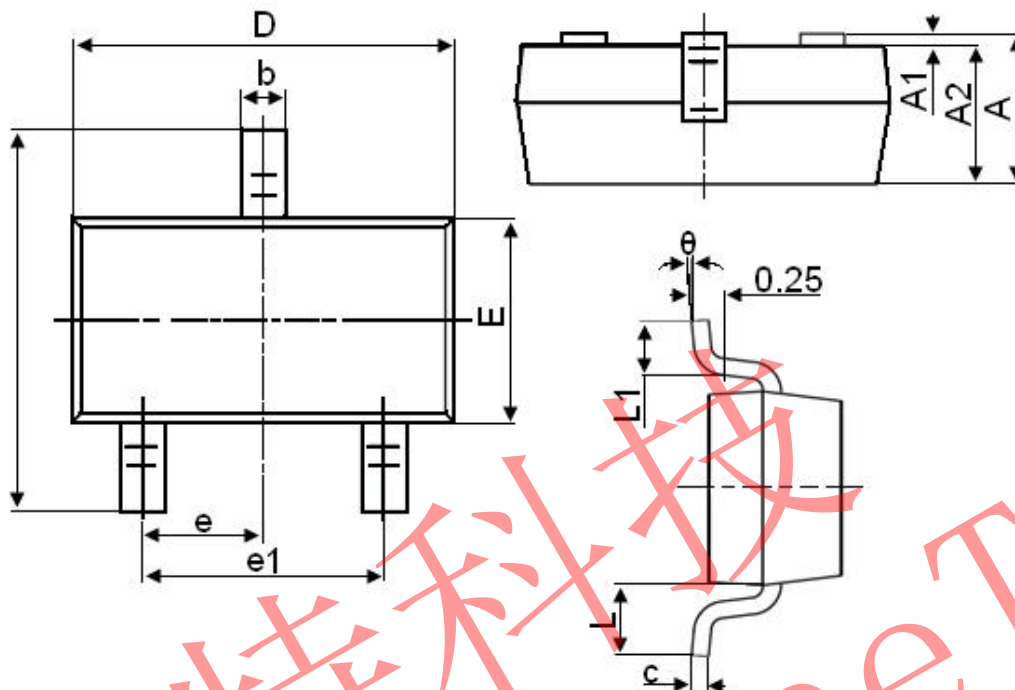

Symbol	Dimensions in Millimeters	
	MIN.	MAX.
A	0.900	1.150
A1	0.000	0.100
A2	0.900	1.050
b	0.300	0.500
c	0.080	0.150
D	2.800	3.000
E	1.200	1.400
E1	2.250	2.550
e	0.950 TYP.	
e1	1.800	2.000
L	0.550 REF.	
L1	0.300	0.500
θ	0°	8°