



P-Channel Enhancement Mode Power MOSFET

Description

The MX3401A uses advanced trench technology to provide excellent $R_{DS(ON)}$, low gate charge and operation with gate voltages as low as 2.5V.

This device is suitable for use as a load switch or in PWM applications.

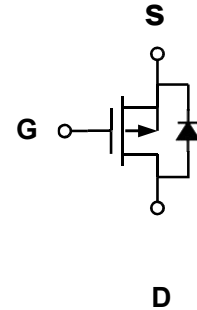

Schematic diagram

General Features

- ◆ $V_{DS} = -30V$, $I_D = -4.2A$
- ◆ @ $V_{GS} = -10V$ $R_{DS(ON)}$ (Typ.)=45m Ω
- ◆ @ $V_{GS} = -4.5V$ $R_{DS(ON)}$ (Typ.)=52m Ω
- ◆ @ $V_{GS} = -2.5V$ $R_{DS(ON)}$ (Typ.)=70m Ω
- ◆ High power and current handling capability
- ◆ Lead free product is acquired
- ◆ Surface mount package

Application

- ◆ PWM applications
- ◆ Load switch
- ◆ Power management

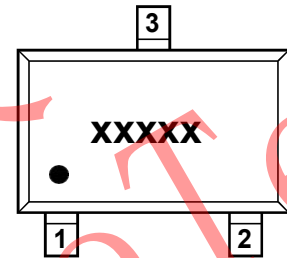

Marking and pin assignment



SOT-23 (TOP VIEW)

Absolute Maximum Ratings (TA=25°C unless otherwise noted)

parameter	symbol	limit	unit
Drain-source voltage	V_{DS}	-30	V
Gate-source voltage	V_{GS}	± 12	V
Drain current-continuous ^a @Tj=125°C -pulse ^b	I_D	-4.2	A
	I_{DM}	-30	A
Maximum power dissipation	P_D	1.2	W
Operating junction Temperature range	T_j	-55—150	°C



Electrical Characteristics (TA=25°C unless otherwise noted)

Parameter	Symbol	Condition	Min	Typ	Max	Unit
OFF Characteristics						
Drain-source breakdown voltage	BV_{DSS}	$V_{GS}=0V, I_D=-250\mu A$	-30	-	-	V
Zero gate voltage drain current	I_{DSS}	$V_{DS}=-24V, V_{GS}=0V$	-	-	-1	μA
Gate-body leakage	I_{GSS}	$V_{DS}=0V, V_{GS}=\pm 10V$	-	-	± 100	nA
ON Characteristics						
Gate threshold voltage	$V_{GS(th)}$	$V_{DS}=V_{GS}, I_D=-250\mu A$	-0.7	-1	-1.3	V
Drain-source on-state resistance	$R_{DS(ON)}$	$V_{GS}=-10V, I_D=-4.2A$		40	50	m Ω
		$V_{GS}=-4.5V, I_D=-4A$	-	52	65	
		$V_{GS}=-2.5V, I_D=-1A$	-	70	100	
Forward transconductance	g_{fs}	$V_{GS}=-5V, I_D=-4.2A$	-	10	-	S
Dynamic Characteristics						
Input capacitance	C_{iss}	$V_{DS}=-15V, V_{GS}=0V$ $f=1.0MHz$	-	950	-	pF
Output capacitance	C_{oss}		-	115	-	
Reverse transfer capacitance	C_{rss}		-	75	-	
Switching Characteristics						
Turn-on delay time	$t_{D(ON)}$	$V_{DD}=-15V$ $I_D=-3.2A$ $V_{GEN}=-10V$ $R_{GEN}=6ohm$	-	7	-	ns
Rise time	t_r		-	3	-	
Turn-off delay time	$t_{D(OFF)}$		-	30	-	
Fall time	t_f		-	12	-	
Total gate charge	Q_g	$V_{DS}=-15V, I_D=-4.0A$ $V_{GS}=-4.5V$	-	9.5	-	nC
Gate-source charge	Q_{gs}		-	2	-	
Gate-drain charge	Q_{gd}		-	3	-	
DRAIN-SOURCE DIODE CHARACTERISTICS						
Diode forward voltage	V_{SD}	$V_{GS}=0V, I_s=-1A$	-	-	-1.2	V

Notes:

- a. surface mounted on FR4 board, $t \leq 10sec$
- b. pulse test: pulse width $\leq 300\mu s$, duty $\leq 2\%$
- c. guaranteed by design, not subject to production testing

Thermal Characteristics

Thermal Resistance junction-to ambient	Rth JA	104	$^{\circ}C/W$
--	--------	-----	---------------



Typical Electrical and Thermal Characteristics

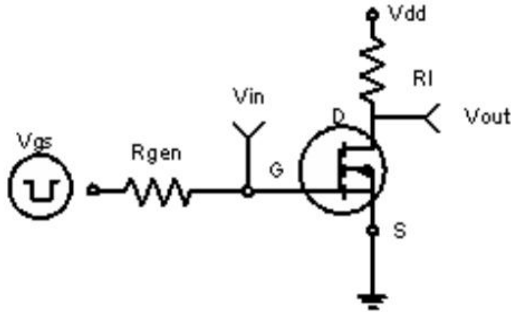

Figure 1: Switching Test Circuit

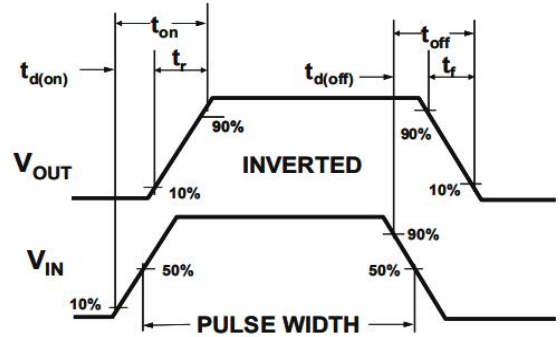

Figure 2: Switching Waveforms

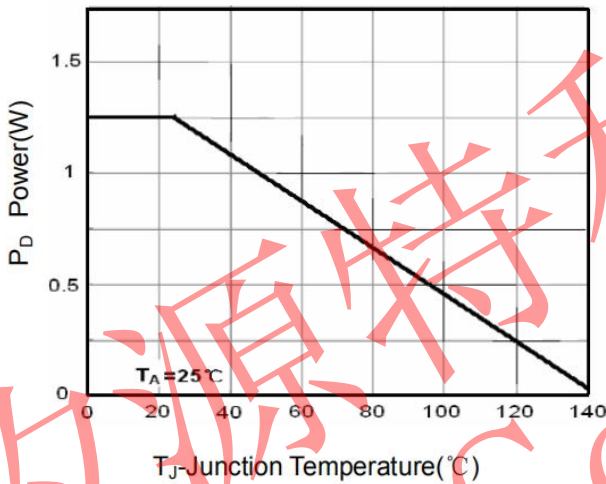

Figure 3 Power Dissipation

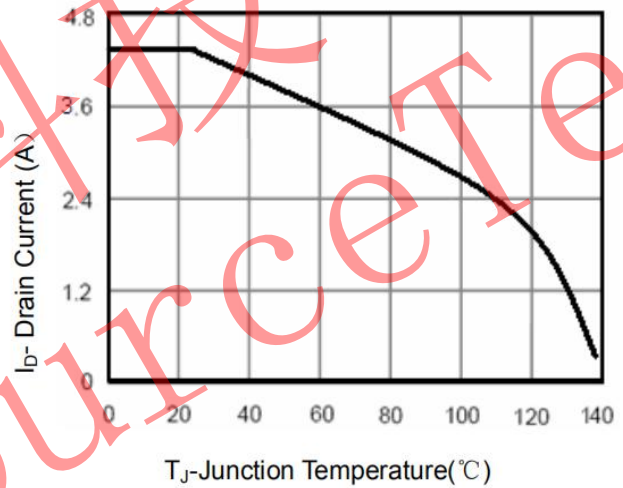

Figure 4 Drain Current

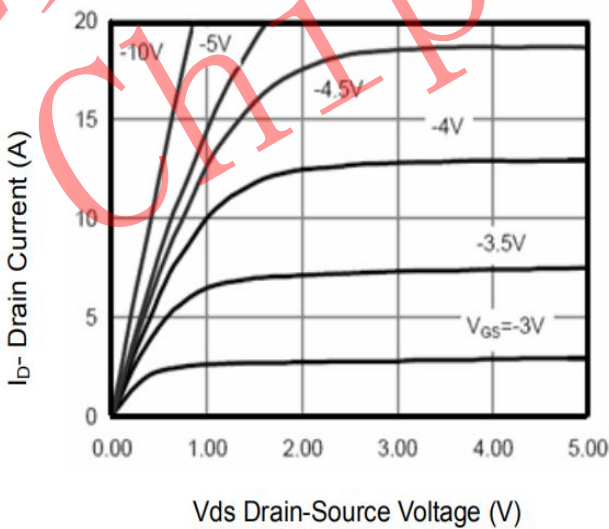

Figure 5 Output Characteristics

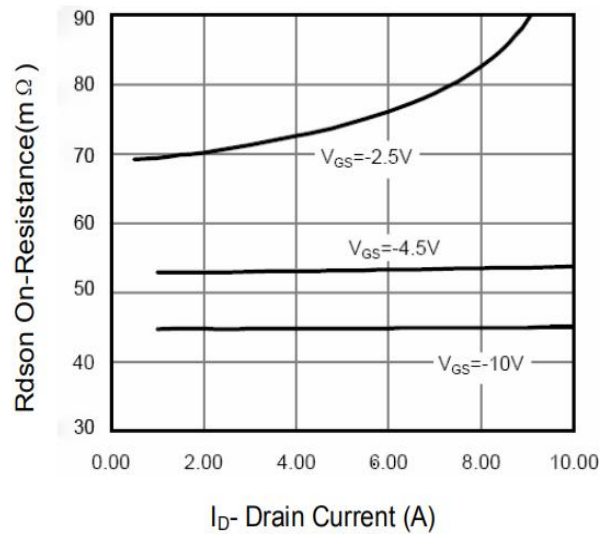

Figure 6 Drain-Source On-Resistance

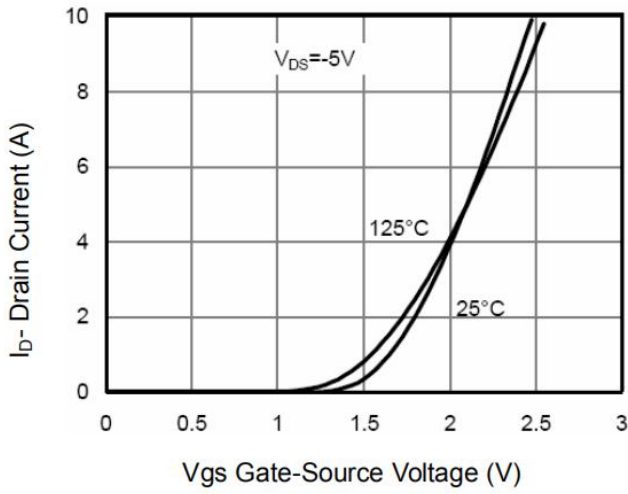

Figure 7 Transfer Characteristics

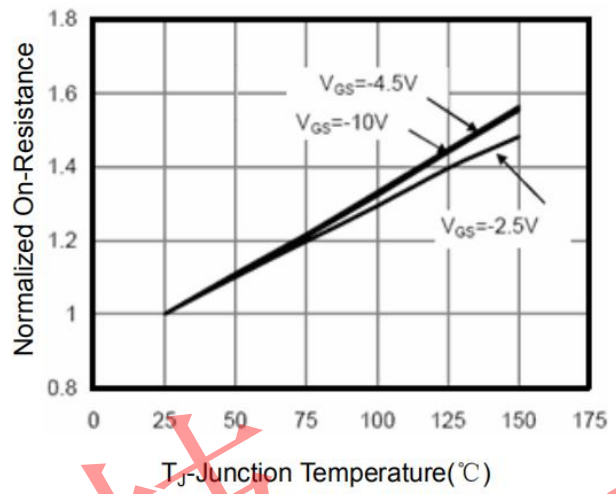

Figure 8 Drain-Source On-Resistance

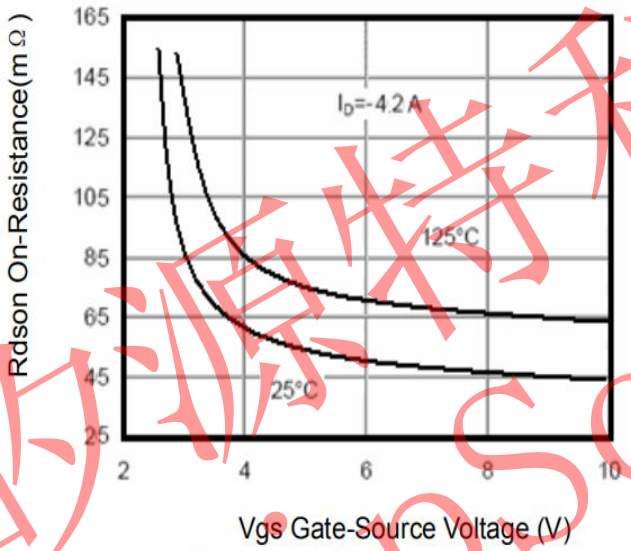

Figure 9 Rdson vs Vgs

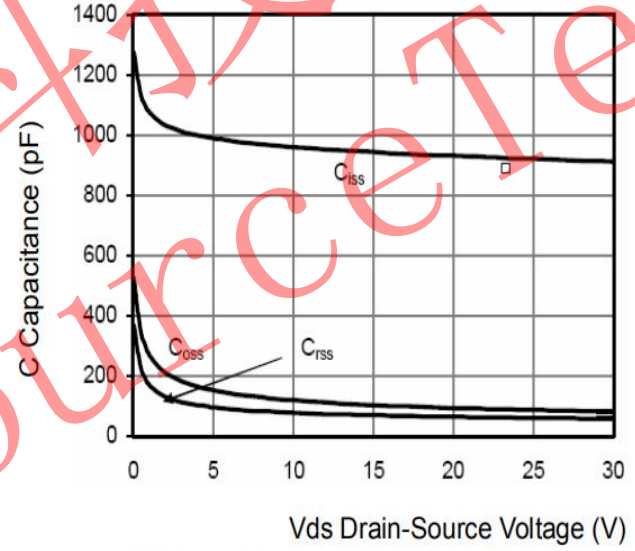

Figure 10 Capacitance vs Vds

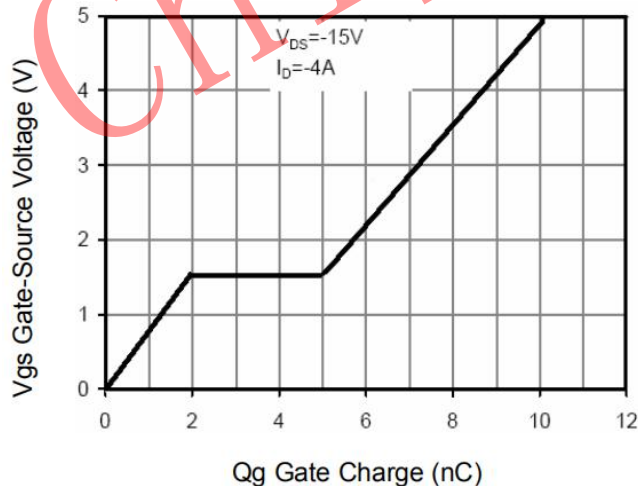

Figure 11 Gate Charge

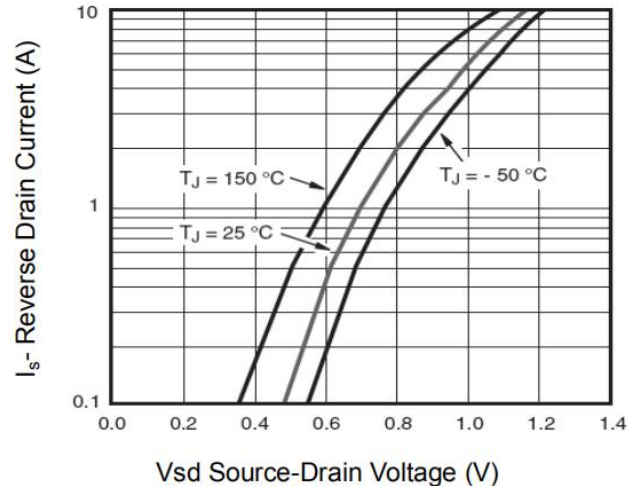

Figure 12 Source- Drain Diode Forward

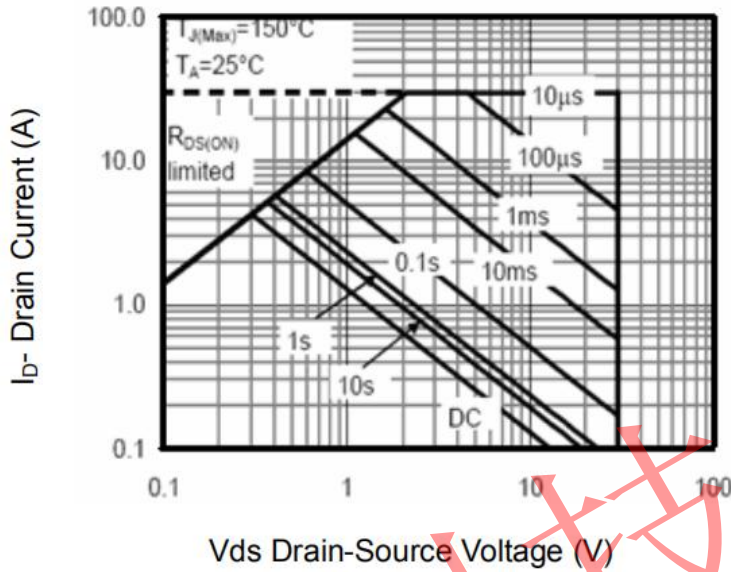

Figure 13 Safe Operation Area

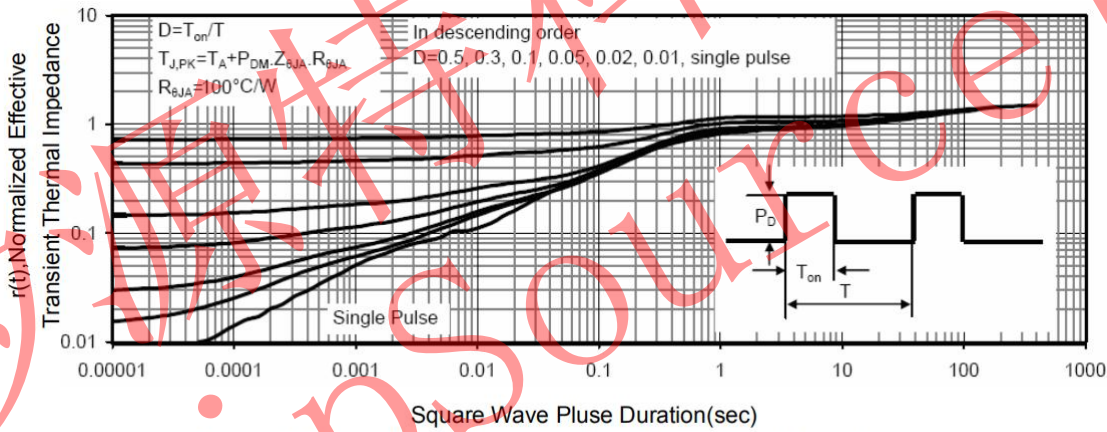
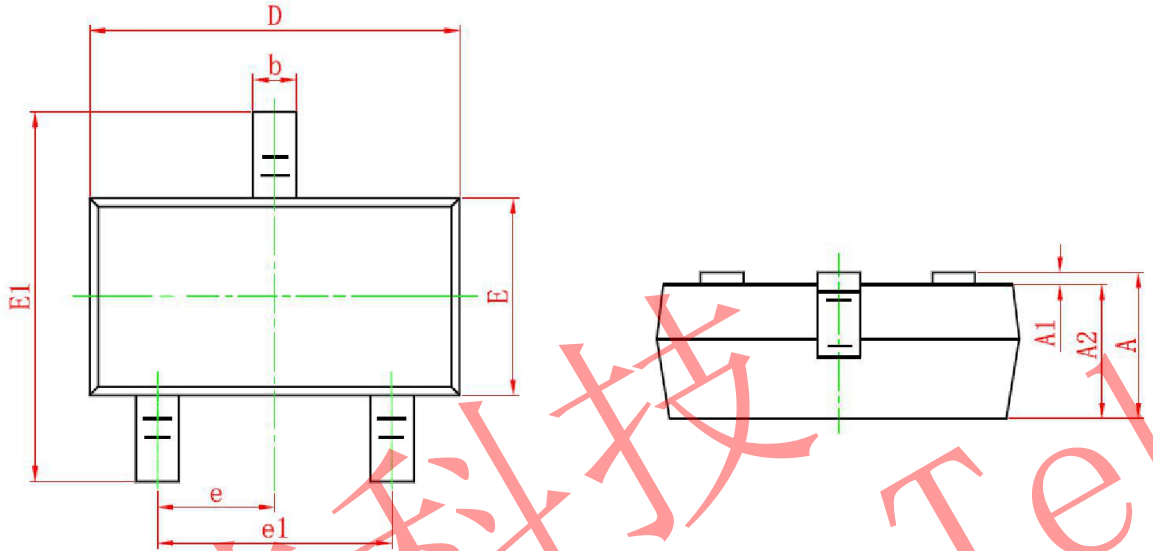

Figure 14 Normalized Maximum Transient Thermal Impedance



SOT-23 Package Information



Symbol	Dimensions in Millimeters	
	MIN.	MAX.
A	0.900	1.150
A1	0.000	0.100
A2	0.900	1.050
b	0.300	0.500
c	0.080	0.150
D	2.800	3.000
E	1.200	1.400
E1	2.250	2.550
e	0.950TYP	
e1	1.800	2.000
L	0.550REF	
L1	0.300	0.500
θ	0°	8°