

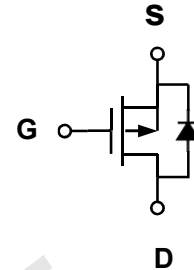

P-Channel Enhancement Mode Power MOSFET

Description

The MX3407A uses advanced trench technology to provide excellent $R_{DS(ON)}$. This device is suitable for use as a load switch or in PWM applications.



General Features

- ◆ $V_{DS} = -30V$, $I_D = -4.3A$
- ◆ $R_{DS(ON)}$ (Typ.) $54m\Omega @ V_{GS} = -4.5V$
- ◆ $R_{DS(ON)}$ (Typ.) $38m\Omega @ V_{GS} = -10V$
- ◆ High power and current handling capability
- ◆ Lead free product is acquired
- ◆ Surface mount package

Schematic diagram

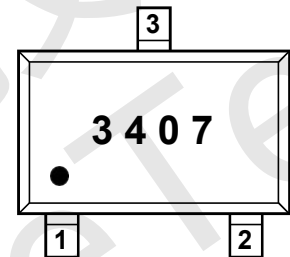

Application

- ◆ PWM applications
- ◆ Load switch
- ◆ Power management

Marking and pin assignment



Sot-23 top view

Ordering Information

Part Number	Marking	Storage Temperature	Package	Devices Per Reel
MX3407A	XXXXX	-55°C to +150°C	SOT-23-3	3000

Absolute Maximum Ratings (TA=25°C unless otherwise noted)

parameter	symbol	limit	unit
Drain-source voltage	V_{DS}	-30	V
Gate-source voltage	V_{GS}	± 20	V
Drain current-continuous Drain Current-Pulsed (Note 1)	I_D	-4.3	A
	I_{DM}	-20	A
Drain-source Diode forward current	I_S	-1.25	A
Maximum power dissipation	P_D	1	W
Operating junction Temperature range	T_j	-55—150	°C



Electrical Characteristics (TA=25°C unless otherwise noted)

Parameter	Symbol	Condition	Min	Typ	Max	Unit
OFF Characteristics						
Drain-source breakdown voltage	BV_{DSS}	$V_{GS}=0V, I_D=-250\mu A$	-30	-	-	V
Zero gate voltage drain current	I_{DSS}	$V_{DS}=-24V, V_{GS}=0V$	-	-	-1	μA
Gate-body leakage	I_{GSS}	$V_{DS}=0V, V_{GS}=\pm 20V$	-	-	± 100	nA
ON Characteristics						
Gate threshold voltage	$V_{GS(th)}$	$V_{DS}=V_{GS}, I_D=-250\mu A$	-1	-1.5	-3	V
Drain-source on-state resistance	$R_{DS(ON)}$	$V_{GS}=-10V, I_D=-4.1A$	-	38	52	m Ω
		$V_{GS}=-4.5V, I_D=-4A$	-	54	90	m Ω
Forward transconductance	g_{fs}	$V_{GS}=-5V, I_D=-4.1A$	-5.5	-	-	V
Dynamic Characteristics						
Input capacitance	C_{ISS}	$V_{DS}=-15V, V_{GS}=0V$ $f=1.0MHz$	-	700	-	pF
Output capacitance	C_{OSS}		-	120	-	
Reverse transfer capacitance	C_{RSS}		-	75	-	
Switching Characteristics						
Turn-on delay time	$t_{D(ON)}$	$V_{DD}=-15V$ $V_{GEN}=-10V$ $R_L=3.6ohm$ $R_{GEN}=3ohm$	-	9	-	ns
Rise time	t_r		-	5	-	
Turn-off delay time	$t_{D(OFF)}$		-	28	-	
Fall time	t_f		-	13.5	-	
Total gate charge	Q_g	$V_{DS}=-15V, I_D=-4A$ $V_{GS}=-10V$	-	14	-	nC
Gate-source charge	Q_{gs}		-	3.1	-	
Gate-drain charge	Q_{gd}		-	3.	-	
DRAIN-SOURCE DIODE CHARACTERISTICS						
Diode forward voltage	V_{SD}	$V_{GS}=0V, I_s=-1A$	-	-	-1.2	V

Notes:

1. Repetitive Rating: Pulse width limited by maximum junction temperature.
2. Surface Mounted on FR4 Board, $t \leq 10$ sec.
3. Pulse Test: Pulse Width $\leq 300\mu s$, Duty Cycle $\leq 2\%$.
4. Guaranteed by design, not subject to product



Typical Performance Characteristics

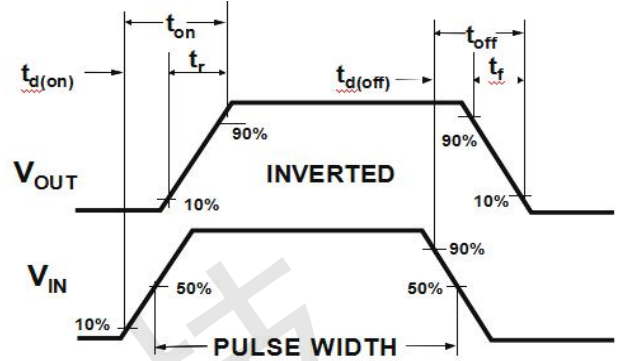
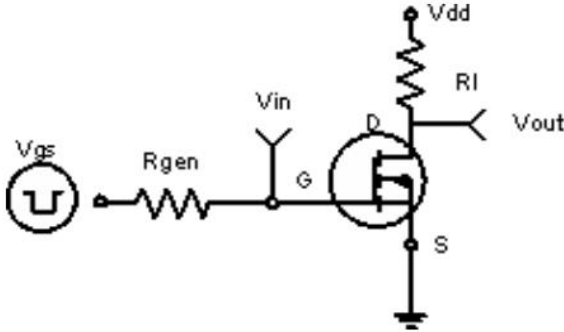

Figure 1: Switching Test Circuit

Figure 2: Switching Waveforms

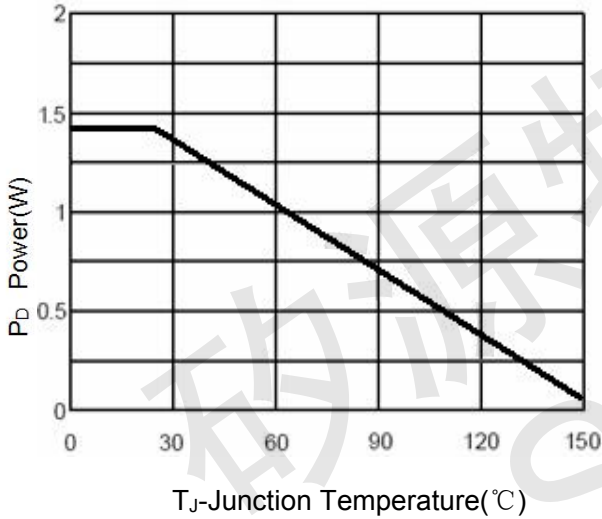

Figure 3 Power Dissipation

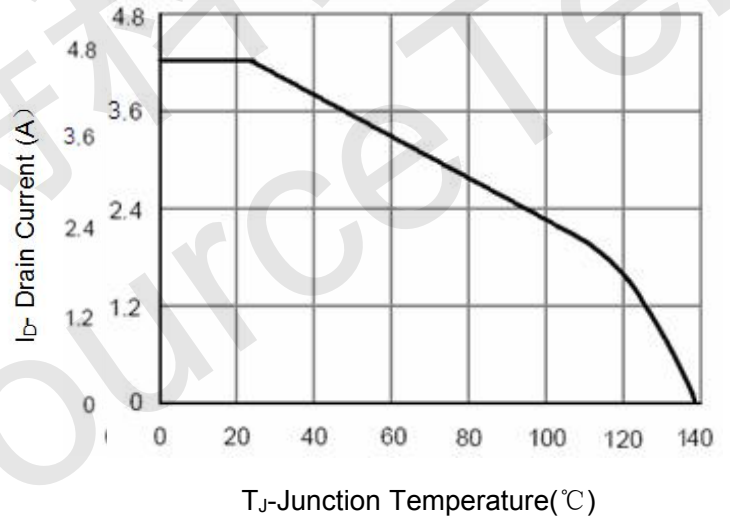

Figure 4 Drain Current

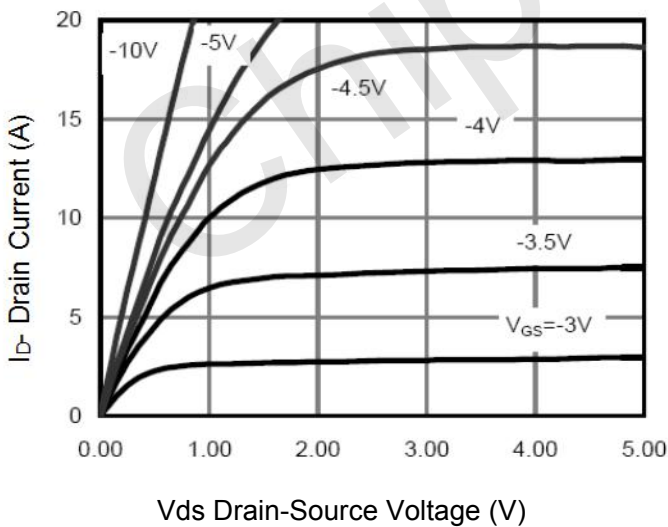

Figure 5 Output CHARACTERISTICS

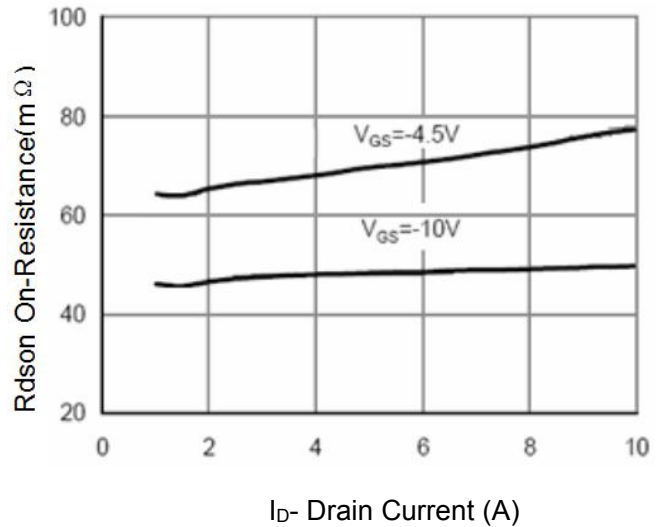

Figure 6 Drain-Source On-Resistance

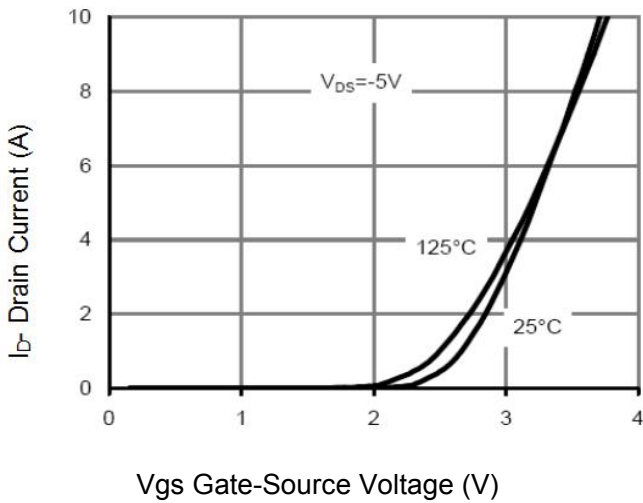

Figure 7 Transfer Characteristics

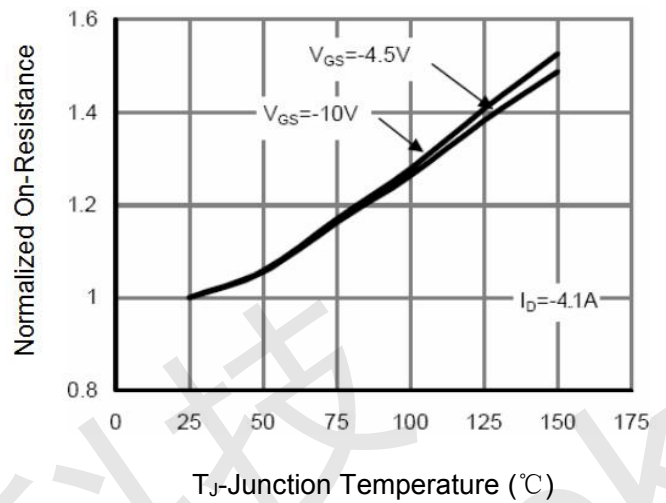

Figure 8 Drain-Source On-Resistance

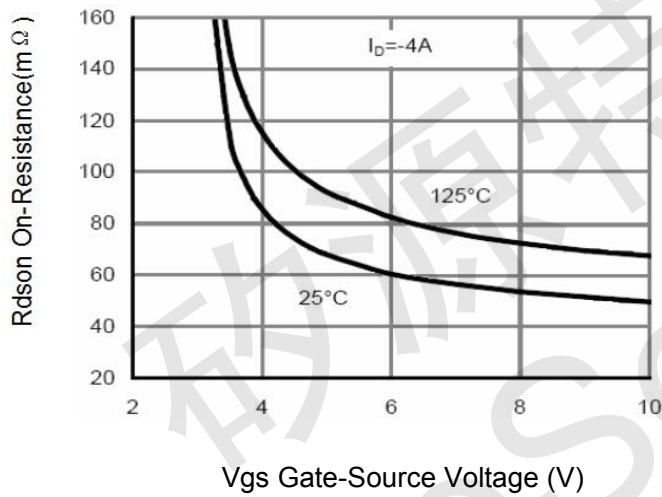

Figure 9 Rdson vs Vgs

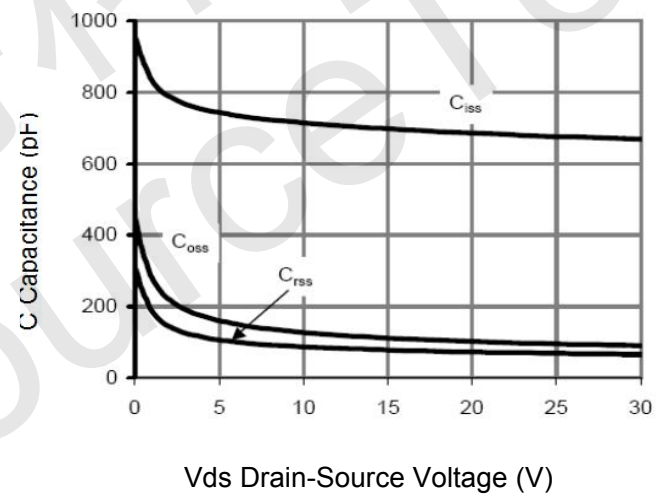

Figure 10 Capacitance vs Vds

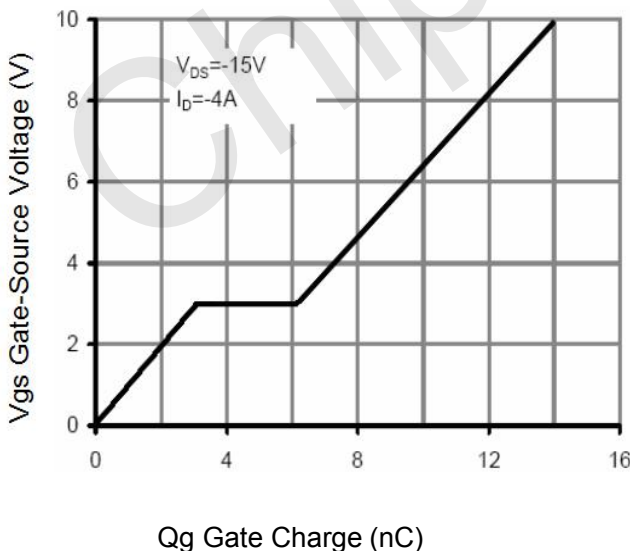

Figure 11 Gate Charge

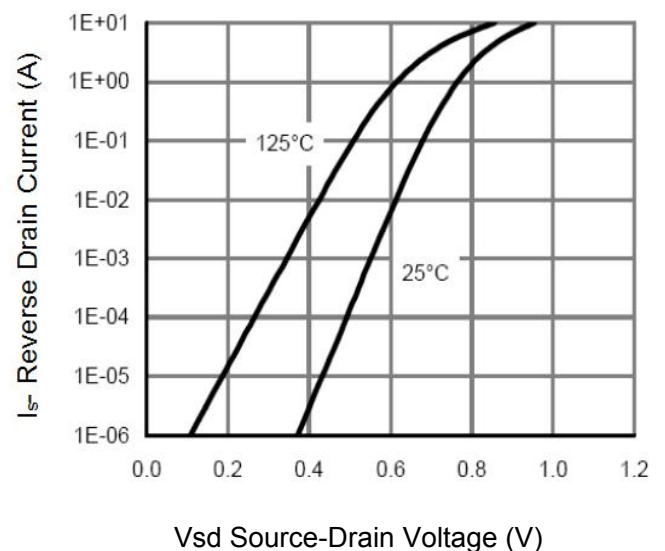

Figure 12 Source- Drain Diode Forward

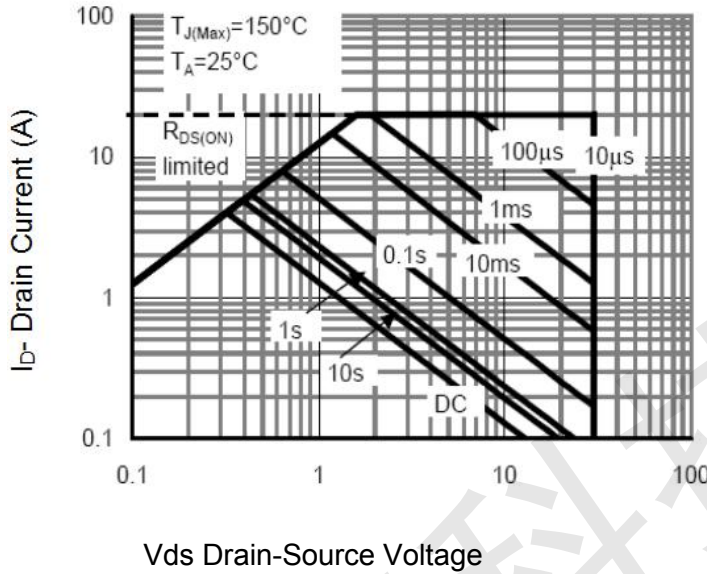

Figure 13 Safe Operation Area

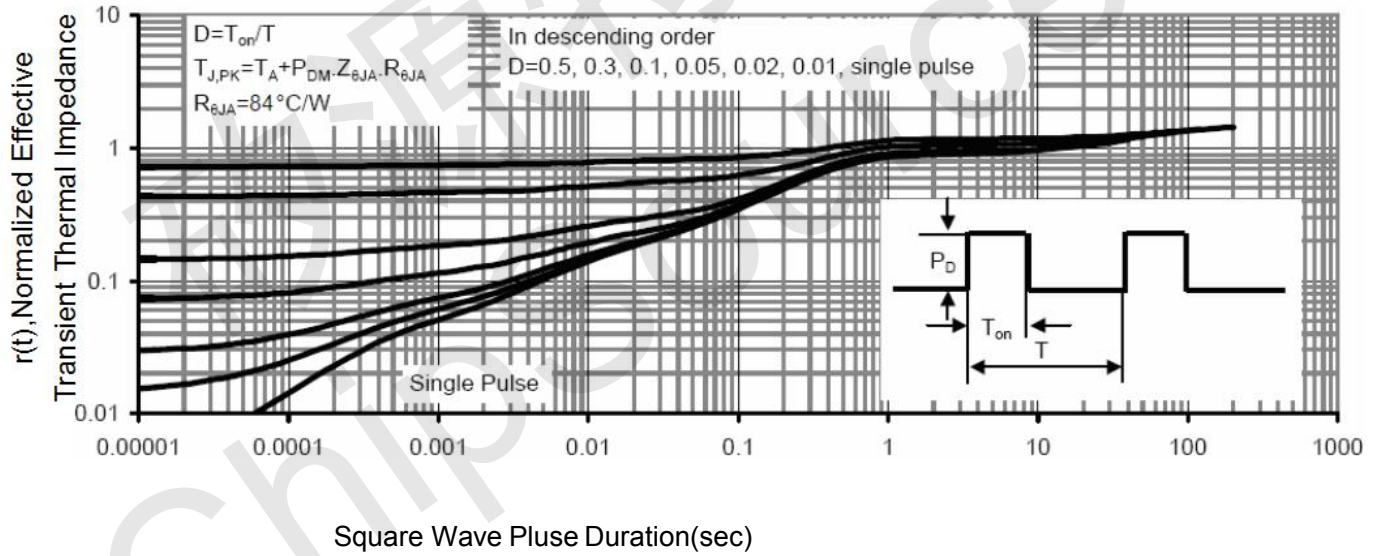
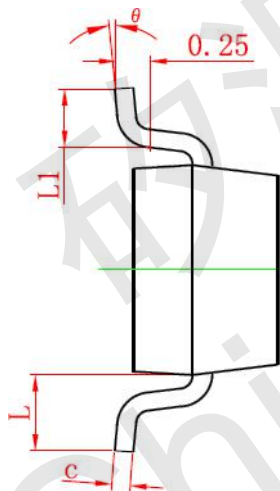
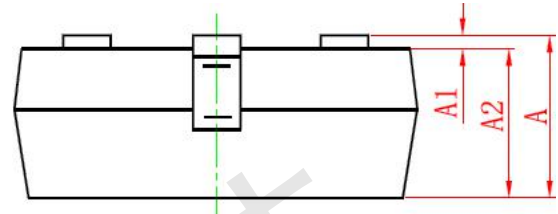
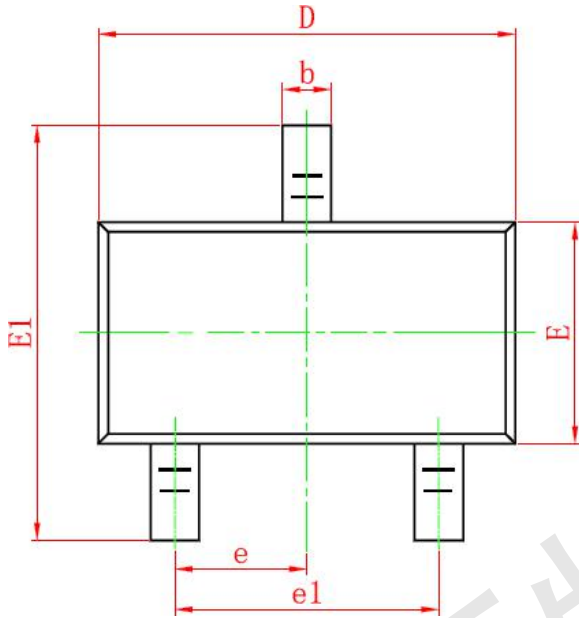

Figure 14 Normalized Maximum Transient Thermal Impedan



SOT-23 PACKAGE INFORMATION



Symbol	Dimensions in Millimeters	
	MIN.	MAX.
A	0.900	1.150
A1	0.000	0.100
A2	0.900	1.050
b	0.300	0.500
c	0.080	0.150
D	2.800	3.000
E	1.200	1.400
E1	2.250	2.550
e	0.950TYP	
e1	1.800	2.000
L	0.550REF	
L1	0.300	0.500