



P-Channel Enhancement Mode Power MOSFET MX4407A

DESCRIPTION

The MX4407A uses advanced trench technology to provide excellent $R_{DS(ON)}$, low gate charge and operation with gate voltages as low as 4.5V. This device is suitable for use as a load switch or in PWM applications.

GENERAL FEATURES

- $V_{DS} = -30V, I_D = -12A$
 $R_{DS(ON)}$ (Type) = $9.0m\Omega$ @ $V_{GS} = -10V$
 $R_{DS(ON)}$ (Type) = $12m\Omega$ @ $V_{GS} = -4.5V$
- High Power and current handling capability
- Lead free product is acquired
- Surface Mount Package

APPLICATION

- PWM applications
- Load switch
- Power management

PINOUT

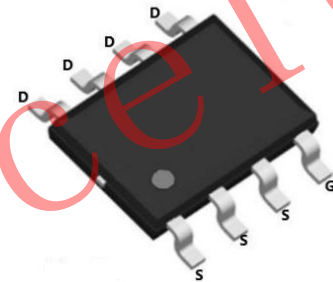
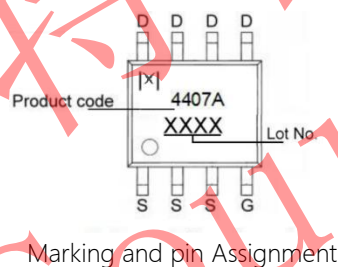
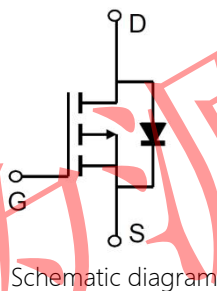

KEY PERFORMANCE PARAMETERS

Parameter	Value	Unit
V_{DS} @ $T_A = 25^\circ C$	-30	V
$R_{DS(on)}$ (Type) @ $V_{GS} = -10V$	9.0	$m\Omega$
$R_{DS(on)}$ (Type) @ $V_{GS} = -4.5V$	12	$m\Omega$
Q_g (Type)	61.9	nC
I_D @ $T_A = 25^\circ C$	-14	A
P_D @ $T_A = 25^\circ C$	2.9	W
T_j, T_{STG}	-55 to 150	$^\circ C$

PACKAGE INFORMATION

Package	SOP8
---------	------



P-Channel Enhancement Mode Power MOSFET **MX4407A**



ABSOLUTE MAXIMUM RATINGS (TA=25°C unless otherwise noted)

Parameter	Symbol	Limit	Unit
Drain-Source Voltage	V _{DS}	-30	V
Gate-Source Voltage	V _{GS}	±25	V
Drain Current-Continuous	I _D	-12	A
Drain Current-Pulsed ^①	I _{DM}	-56	A
Maximum Power Dissipation	P _D	2.9	W
Operating Junction and Storage Temperature Range	T _J , T _{STG}	-55 To 150	°C



THERMAL RESISTANCE

Parameter	Symbol	Max.	Unit
Thermal Resistance, Junction-to-Ambient ^②	R _{θJA}	42	°C/W

Notes:

- ① Repetitive Rating: Pulse width limited by maximum junction temperature
- ② Surface Mounted on FR4 Board, t ≤ 10 sec.



P-Channel Enhancement Mode Power MOSFET **MX4407A**



ELECTRICAL CHARACTERISTICS (TA=25°C unless otherwise noted)

Parameter	Symbol	Condition	Min	Typ	Max	Unit
Off Characteristics						
Drain-Source Breakdown Voltage	BV_{DSS}	$V_{GS}=0V, I_D=-250\mu A$	-30	-	-	V
Zero Gate Voltage Drain Current	I_{DSS}	$V_{DS}=-30V, V_{GS}=0V$	-	-	-1	μA
Gate-Body Leakage Current	I_{GSS}	$V_{GS}=\pm 25V, V_{DS}=0V$	-	-	± 100	nA
On Characteristics ③						
Gate Threshold Voltage	$V_{GS(th)}$	$V_{DS}=V_{GS}, I_D=-250\mu A$	-1.2	-1.7	-2.3	V
Drain-Source On-State Resistance	$R_{DS(on)}$	$V_{GS}=-10V, I_D=-14A$	-	9.0	11.5	m Ω
		$V_{GS}=-4.5V, I_D=-7A$	-	12	16	m Ω
Forward Transconductance	g_{FS}	$V_{DS}=-10V, I_D=-10A$	20	-	-	S
Dynamic Characteristics ④						
Input Capacitance	C_{iss}	$V_{DS}=-15V, V_{GS}=0V,$ $F=1.0MHz$	-	3351	-	PF
Output Capacitance	C_{oss}		-	327.6	-	PF
Reverse Transfer Capacitance	C_{rss}		-	285	-	PF
Switching Characteristics ④						
Turn-on Delay Time	$t_{d(on)}$	$V_{DD}=-15V, I_D=-10A,$ $V_{GS}=-10V, R_{GEN}=3\Omega$	-	12	-	nS
Turn-on Rise Time	t_r		-	7	-	nS
Turn-Off Delay Time	$t_{d(off)}$		-	53	-	nS
Turn-Off Fall Time	t_f		-	16.5	-	nS
Total Gate Charge	Q_g	$V_{DS}=30V, I_D=2.5A,$ $V_{GS}=4.5V$	-	61.9	-	nC
Gate-Source Charge	Q_{gs}		-	9.85	-	nC
Gate-Drain Charge	Q_{gd}		-	11.5	-	nC
Drain-Source Diode Characteristics						
Diode Forward Voltage	V_{SD}	$V_{GS}=0V, I_S=-14A$	-	-0.7	-1.2	V

Notes:

- ③ Pulse Test: Pulse Width $\leq 300\mu s$, Duty Cycle $\leq 2\%$.
- ④ Guaranteed by design, not subject to production



P-Channel Enhancement Mode Power MOSFET **MX4407A**



TYPICAL CHARACTERISTICS ($T_J = 25^\circ\text{C}$, unless otherwise noted)

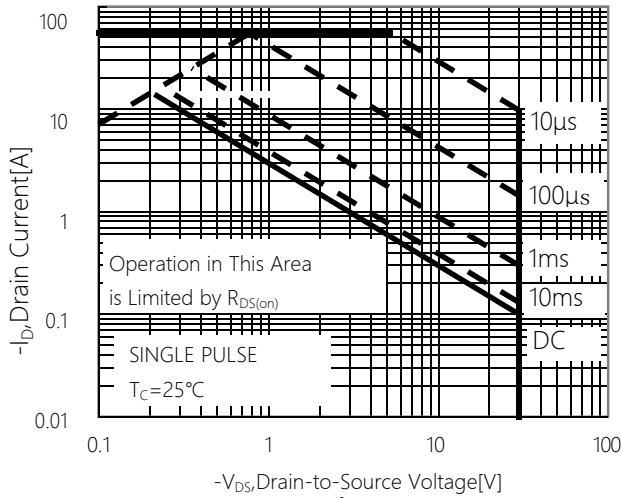

Figure 1: Maximum Safe Operating Area

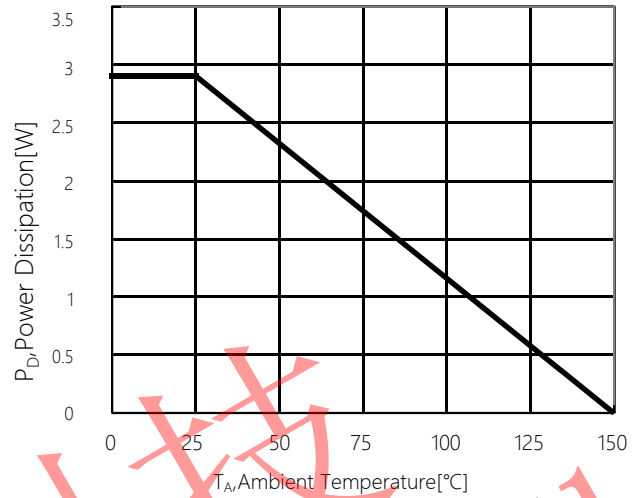

Figure 2: Maximum Power Dissipation vs Ambient Temperature

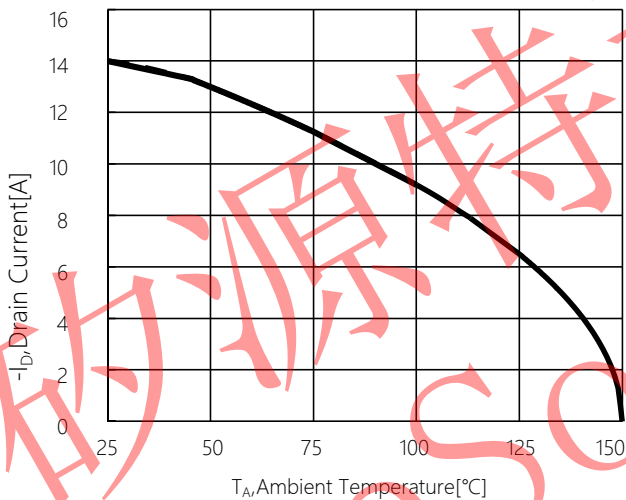

Figure 3: Maximum Continuous Drain Current vs Ambient Temperature

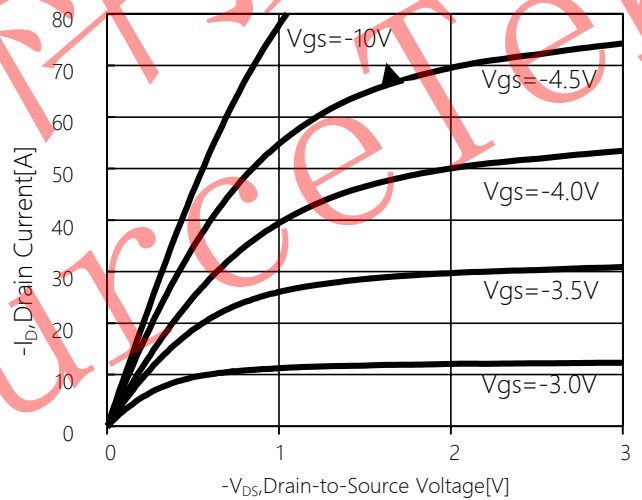

Figure 4: Typical output Characteristics

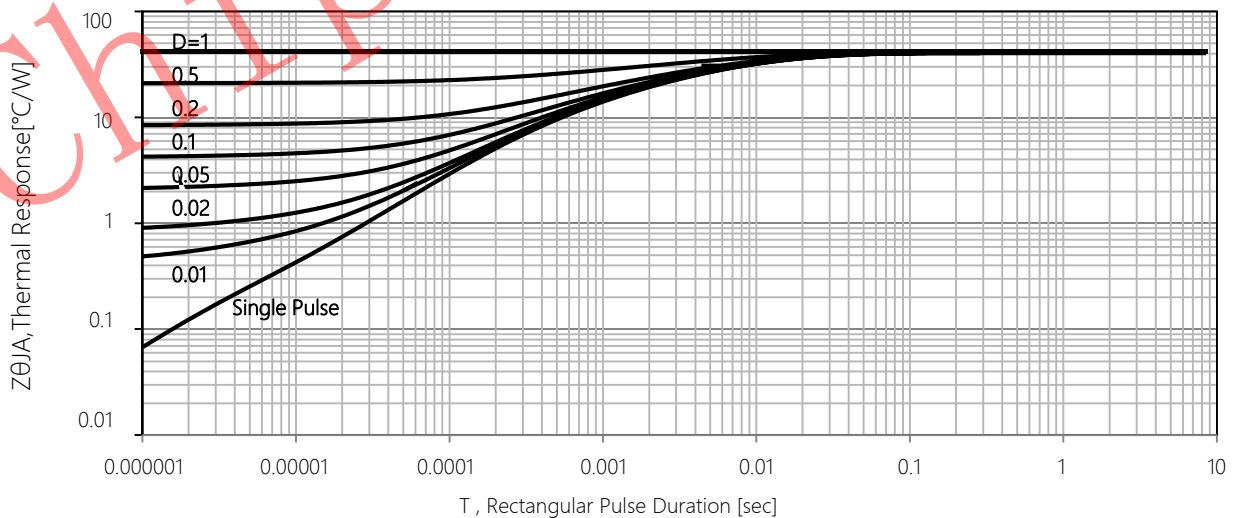

Figure 5: Maximum Effective Thermal Impedance, Junction to Ambient



P-Channel Enhancement Mode Power MOSFET **MX4407A**



TYPICAL CHARACTERISTICS ($T_j = 25^\circ\text{C}$, unless otherwise noted)

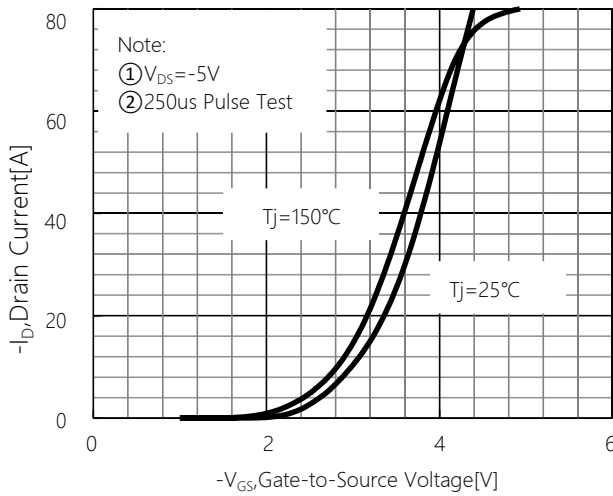

Figure 6: Typical Transfer Characteristics

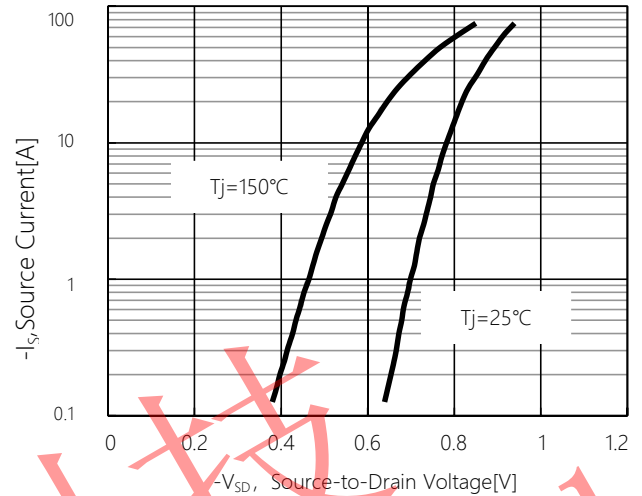

Figure 7: Typical Body Diode Transfer Characteristics

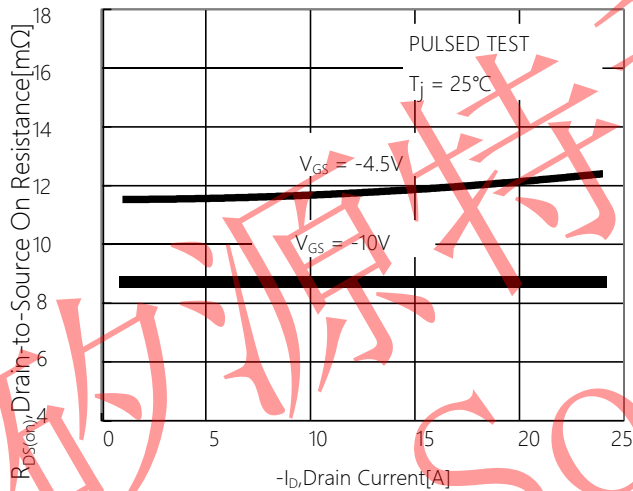

Figure 8: Drain-to-Source On Resistance vs Drain Current

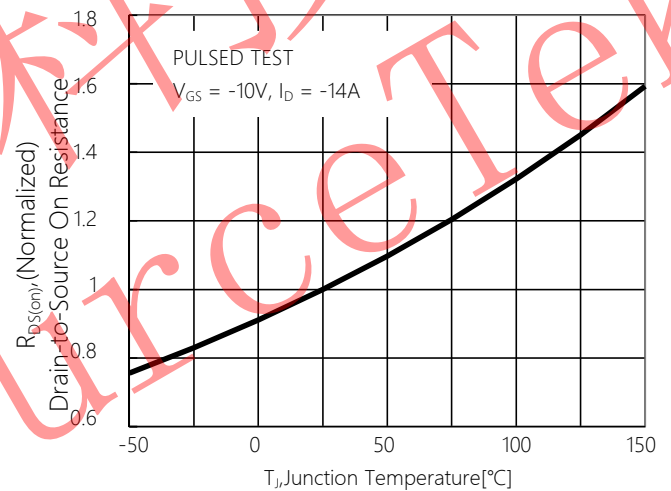

Figure 9: Normalized On Resistance vs Junction Temperature

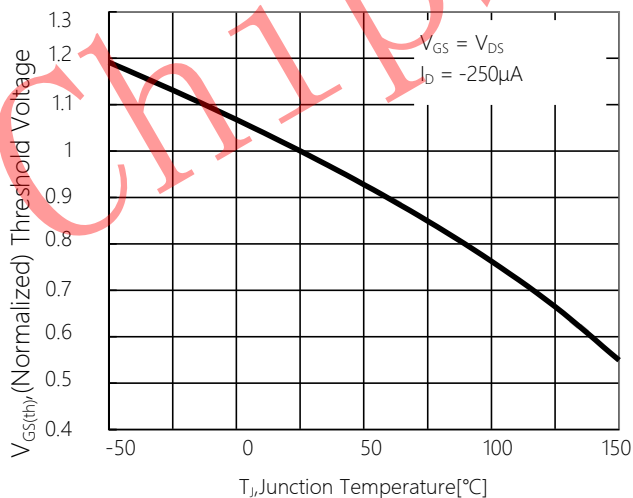

Figure 10: Normalized Threshold Voltage vs Junction Temperature

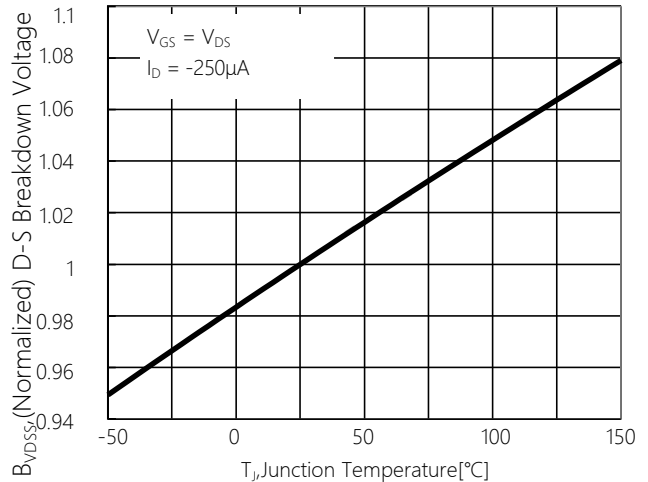

Figure 11: Normalized Breakdown Voltage vs Junction Temperature



P-Channel Enhancement Mode Power MOSFET **MX4407A**



TYPICAL CHARACTERISTICS (T_J = 25°C, unless otherwise noted)

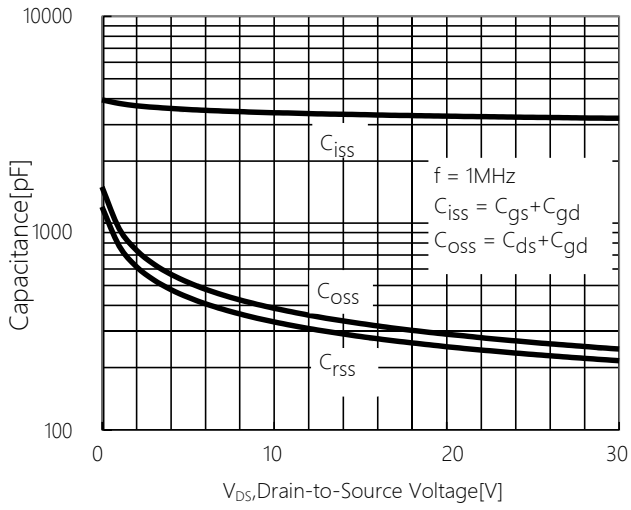

Figure 12: Capacitance Characteristics

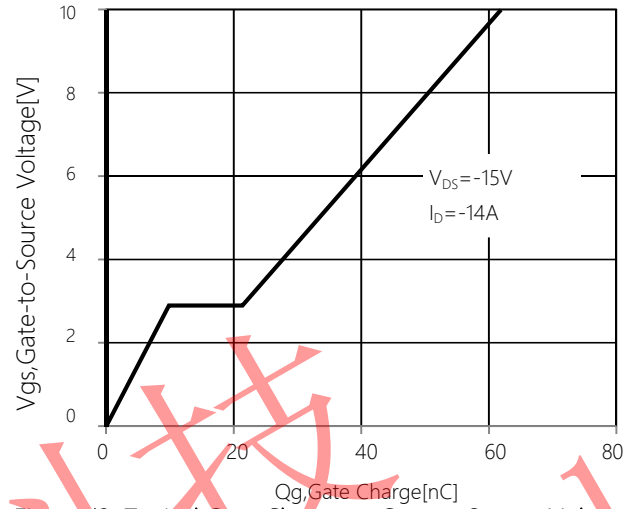

Figure 13: Typical Gate Charge vs Gate to Source Voltage

矽源特科技
ChipSourceTek



P-Channel Enhancement Mode Power MOSFET **MX4407A**

TEST CIRCUIT AND WAVEFORM

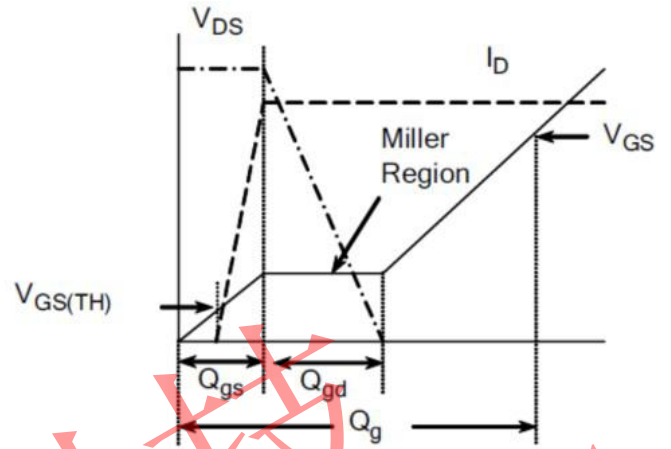
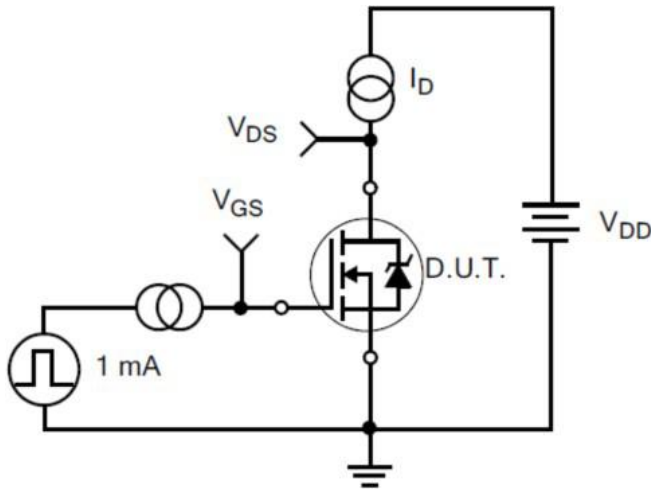

Figure A: Gate Charge Test Circuit and Waveform

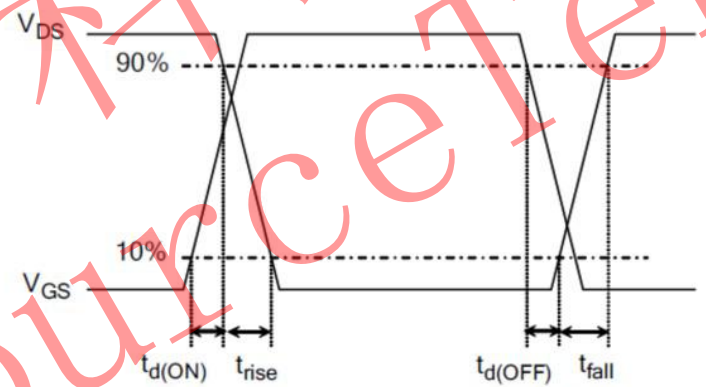
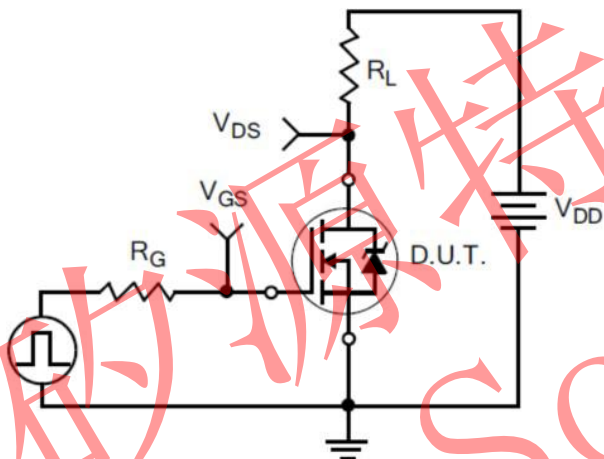

Figure B: Resistive Switching Test Circuit and Waveform

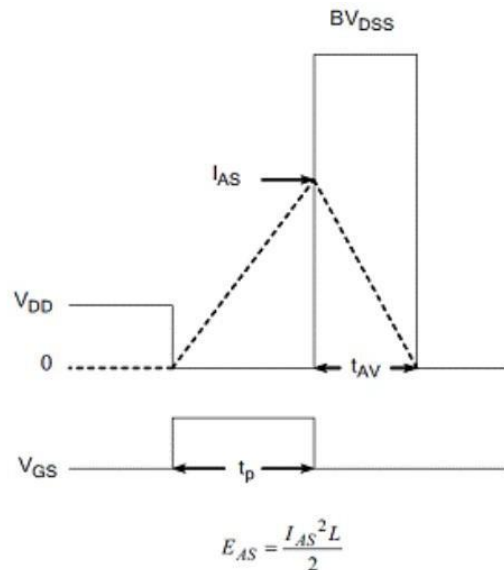
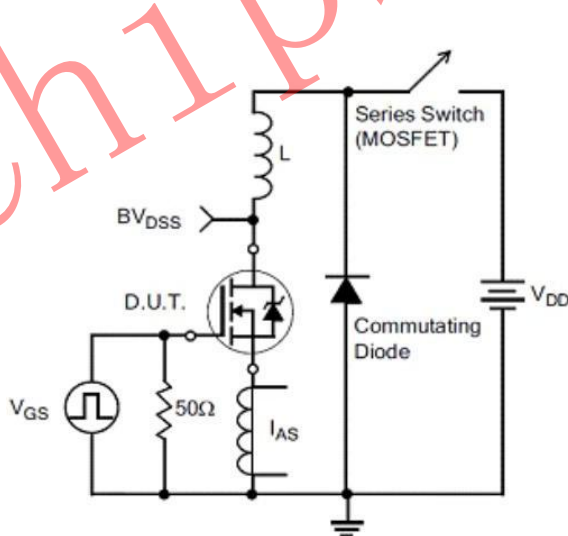

Figure C: Unclamped Inductive Switching Test Circuit and Waveform



P-Channel Enhancement Mode Power MOSFET **MX4407A**



PACKAGE INFORMATION

SOP8

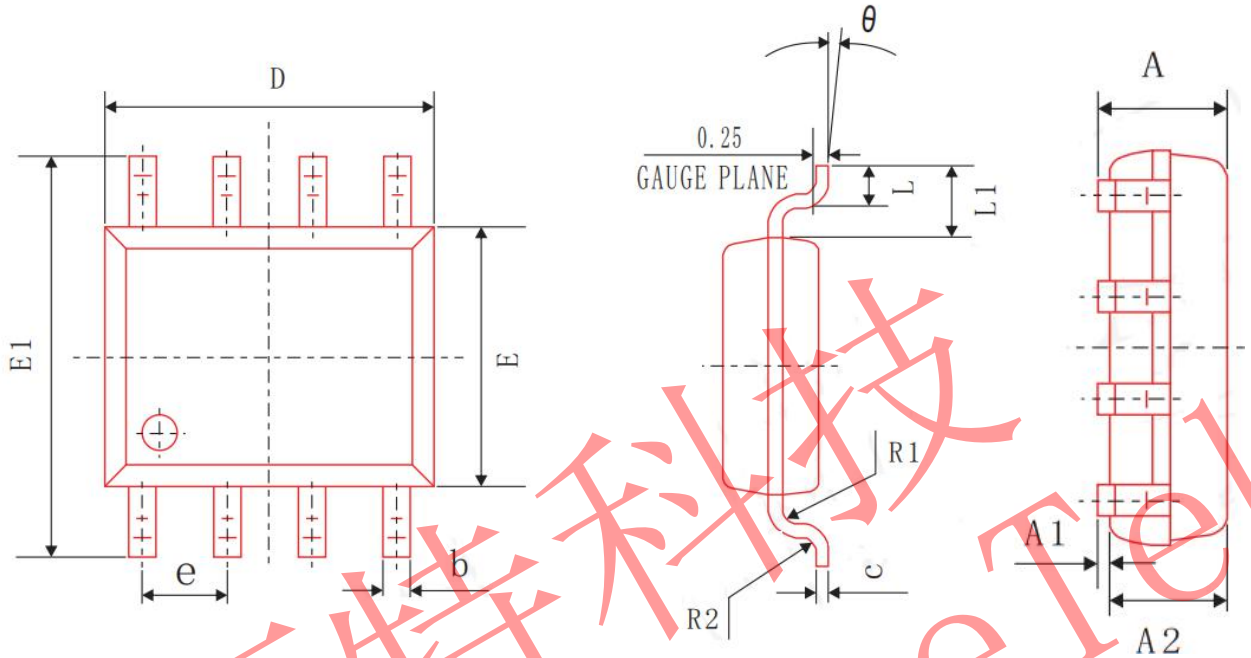

COMMON DIMENSIONS IN MILLIMETERS

SYMBOL	MIN	NOM	MAX
A	1.40	1.60	1.80
A1	0.05	0.15	0.25
A2	1.35	1.45	1.55
b	0.30	0.40	0.50
c	0.153	0.203	0.253
D	4.80	4.90	5.00
E	3.80	3.90	4.00
E1	5.80	6.00	6.20
L	0.45	0.70	1.00
θ	2°	4°	6°
L1		1.04 REF	
e		1.27 BSC	
R1		0.07 TYP	
R2		0.07 TYP	