

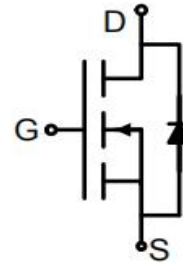

**N-Channel Enhancement Mode Power MOSFET**

**Description**

The MX4468 uses advanced trench technology and design to provide excellent RDS(ON) with low gate charge. It can be used in a wide variety of applications.



**Schematic diagram**

**General Features**

- ◆  $V_{DS} = 30V$ ,  $I_D = 10A$
- ◆  $R_{DS(ON)}(Typ.) < 8m\Omega @ V_{GS} = 10V$
- ◆  $R_{DS(ON)}(Typ.) < 11m\Omega @ V_{GS} = 4.5V$
- ◆ High density cell design for ultra low Rdson
- ◆ Fully characterized Avalanche voltage and current

**Application**

Power switching application  
Hard Switched and High Frequency Circuits  
Uninterruptible Power Supply

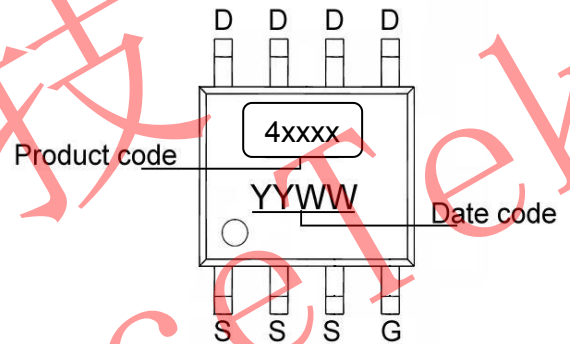

**Marking and pin assignment**

**Absolute Maximum Ratings (TA=25°C unless otherwise noted)**

Parameter	Symbol	Limit	Unit
Drain-Source Voltage	$V_{DS}$	30	V
Gate-Source Voltage	$V_{GS}$	$\pm 20$	V
Drain Current-Continuous	$I_D$	10	A
Drain Current-Continuous( $T_c=100^\circ C$ )	$I_D (100^\circ C)$	6	A
Pulsed Drain Current	$I_{DM}$	50	A
Maximum Power Dissipation	$P_D$	2.5	W
Operating Junction and Storage Temperature Range	$T_J, T_{STG}$	-55 To 150	$^\circ C$



**Electrical Characteristics** (TA=25°C unless otherwise noted)

Parameter	Symbol	Condition	Min	Typ	Max	Unit
<b>Off Characteristics</b>						
Drain-Source Breakdown Voltage	BV <sub>DSS</sub>	V <sub>GS</sub> =0V, I <sub>D</sub> =250μA	30	33	-	V
Zero Gate Voltage Drain Current	I <sub>DSS</sub>	V <sub>DS</sub> =30V, V <sub>GS</sub> =0V	-	-	1	μA
Gate-Body Leakage Current	I <sub>GSS</sub>	V <sub>GS</sub> =±20V, V <sub>DS</sub> =0V	-	-	±100	nA
<b>On Characteristics</b> (Note 3)						
Gate Threshold Voltage	V <sub>GS(th)</sub>	V <sub>DS</sub> =V <sub>GS</sub> , I <sub>D</sub> =250μA	1	1.6	3	V
Drain-Source On-State Resistance	R <sub>DS(ON)</sub>	V <sub>GS</sub> =10V, I <sub>D</sub> =10A	-	8	12	mΩ
		V <sub>GS</sub> =4.5V, I <sub>D</sub> =5A	-	11	16	
Forward Transconductance	g <sub>FS</sub>	V <sub>DS</sub> =5V, I <sub>D</sub> =10A	15	-	-	S
<b>Dynamic Characteristics</b> (Note4)						
Input Capacitance	C <sub>iss</sub>	V <sub>DS</sub> =15V, V <sub>GS</sub> =0V, F=1.0MHz	-	1550	-	PF
Output Capacitance	C <sub>oss</sub>		-	300	-	PF
Reverse Transfer Capacitance	C <sub>rss</sub>		-	180	-	PF
<b>Switching Characteristics</b> (Note 4)						
Turn-on Delay Time	t <sub>d(on)</sub>	V <sub>DD</sub> =25V, I <sub>D</sub> =1A V <sub>GS</sub> =10V, R <sub>GEN</sub> =6Ω	-	30	-	nS
Turn-on Rise Time	t <sub>r</sub>		-	20	-	nS
Turn-Off Delay Time	t <sub>d(off)</sub>		-	100	-	nS
Turn-Off Fall Time	t <sub>f</sub>	V <sub>DS</sub> =15V, I <sub>D</sub> =10A, V <sub>GS</sub> =5V	-	80	-	nS
Total Gate Charge	Q <sub>g</sub>		-	13	-	nC
Gate-Source Charge	Q <sub>gs</sub>		-	5.5	-	nC
Gate-Drain Charge	Q <sub>gd</sub>	-	3.5	-	nC	
<b>Drain-Source Diode Characteristics</b>						
Diode Forward Voltage (Note 3)	V <sub>SD</sub>	V <sub>GS</sub> =0V, I <sub>S</sub> =10A	-	-	1.2	V
Diode Forward Current (Note 2)	I <sub>S</sub>		-	-	10	A

**Notes:**

1. Repetitive Rating: Pulse width limited by maximum junction temperature.
2. Surface Mounted on FR4 Board, t ≤ 10 sec.
3. Pulse Test: Pulse Width ≤ 300μs, Duty Cycle ≤ 2%.
4. Guaranteed by design, not subject to production



## Test Circuit

### 1) EAS Test Circuits

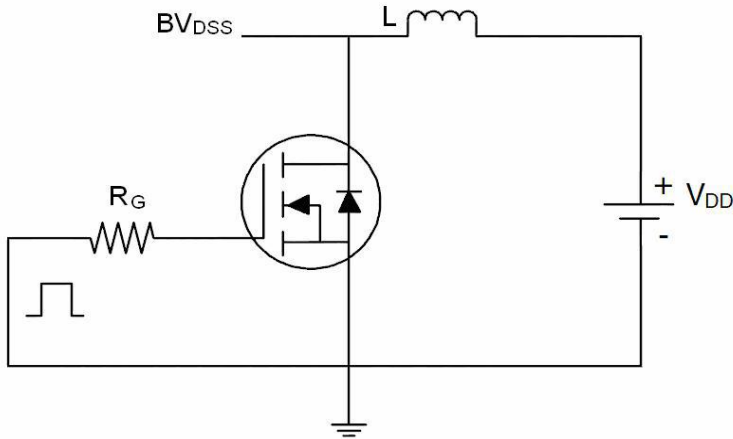

### 2) Gate Charge Test Circuit:

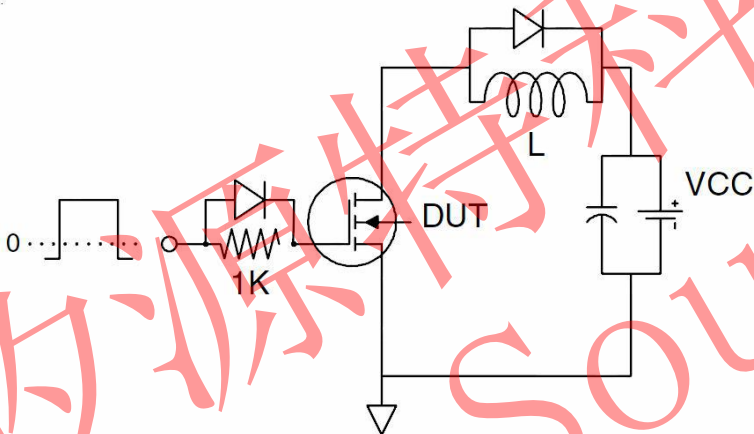

### 3) Switch Time Test Circuit:

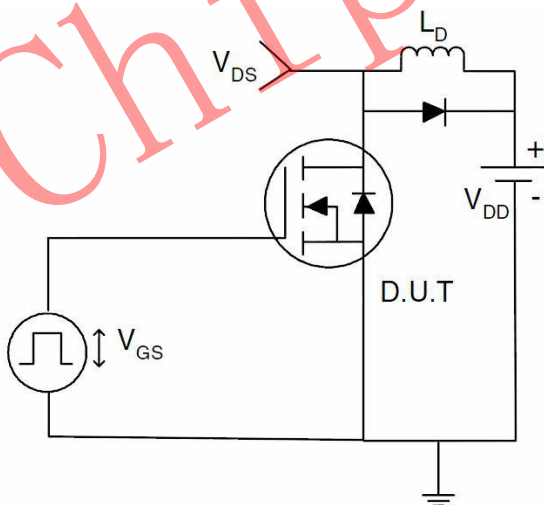



Typical Electrical and Thermal Characteristics (Curves)

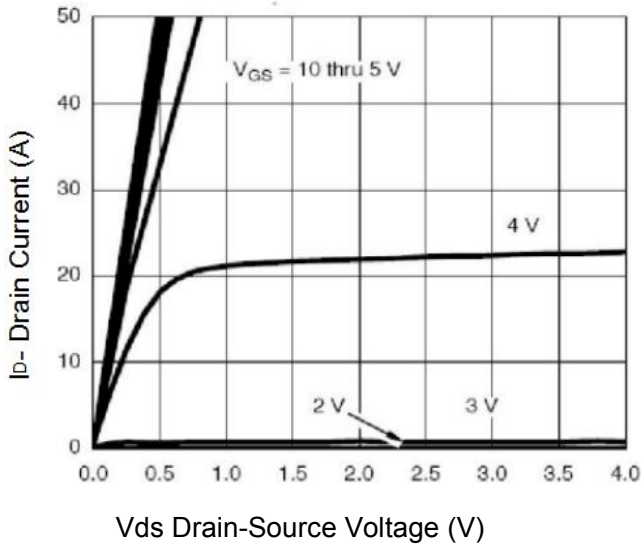

Figure 1 Output Characteristics

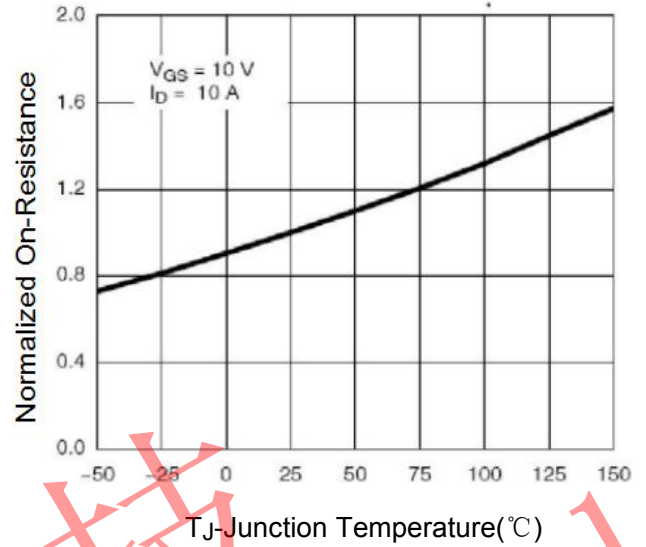

Figure 4 Rds(on)-Junction Temperature

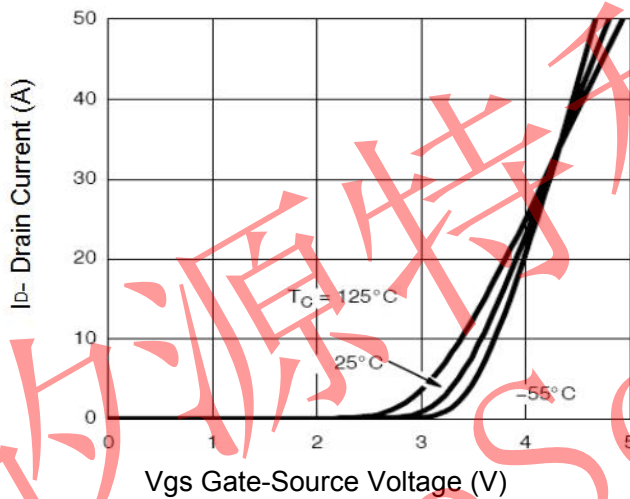

Figure 2 Transfer Characteristics

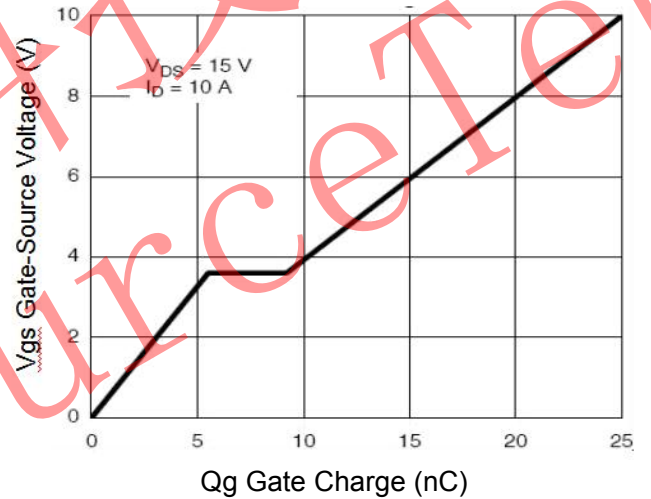

Figure 5 Gate Charge

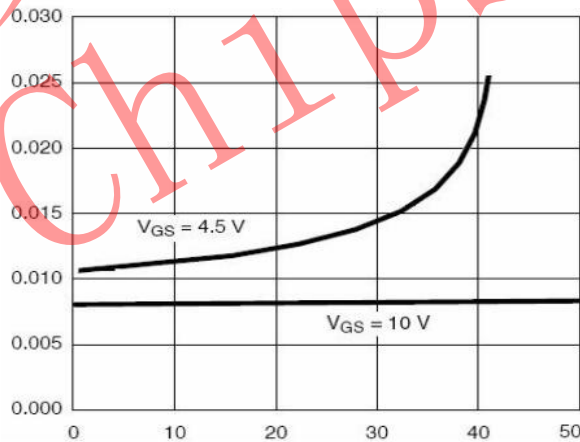

Figure 3 Rds(on)- Drain Current

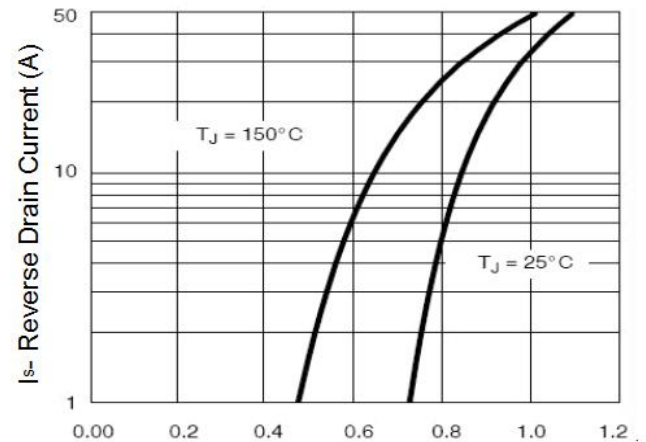
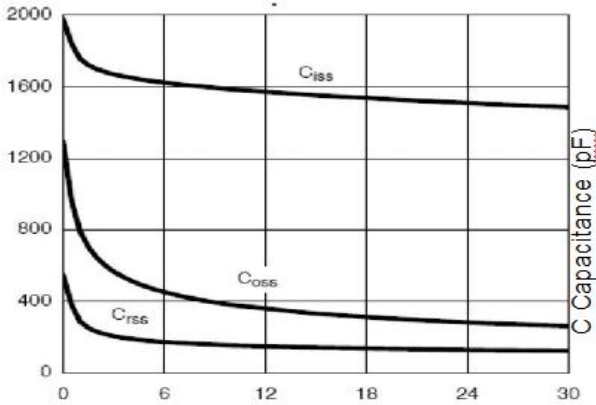
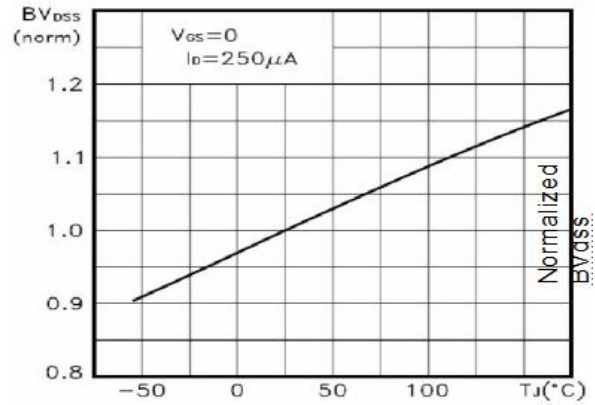

Figure 6 Source- Drain Diode Forward



Vds Drain-Source Voltage (V)  
**Figure 7 Capacitance vs Vds**



Tj-Junction Temperature(°C)  
**Figure 9 BVdss vs Junction Temperature**

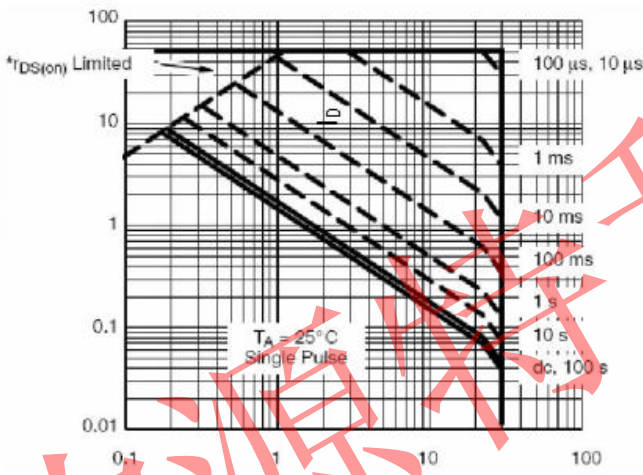

Vds Drain-Source Voltage (V)  
**Figure 8 Safe Operation Area**

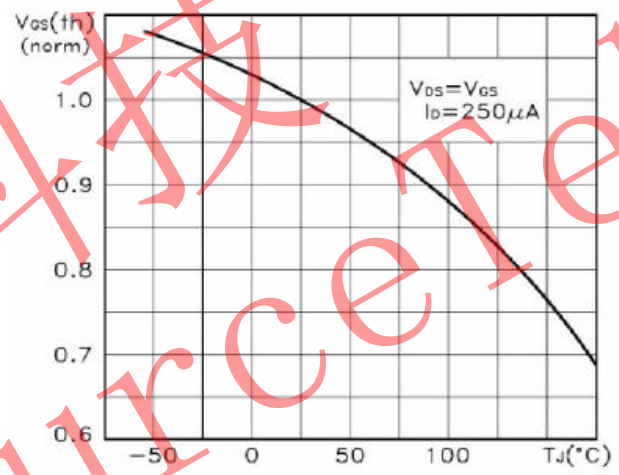

Tj-Junction Temperature(°C)  
**Figure 10 Vgs(th) vs Junction Temperature**

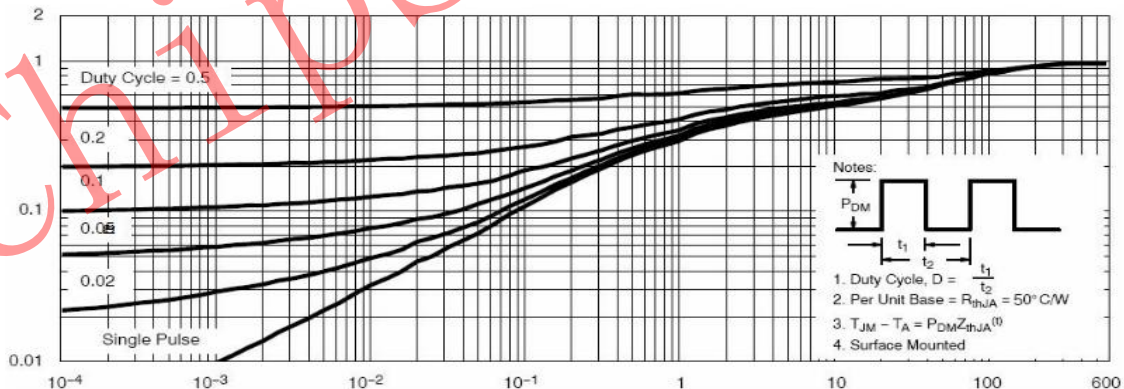

Square Wave Pulse Duration(sec)  
**Figure 11 Normalized Maximum Transient Thermal Impedance**



SOP-8 Package Information

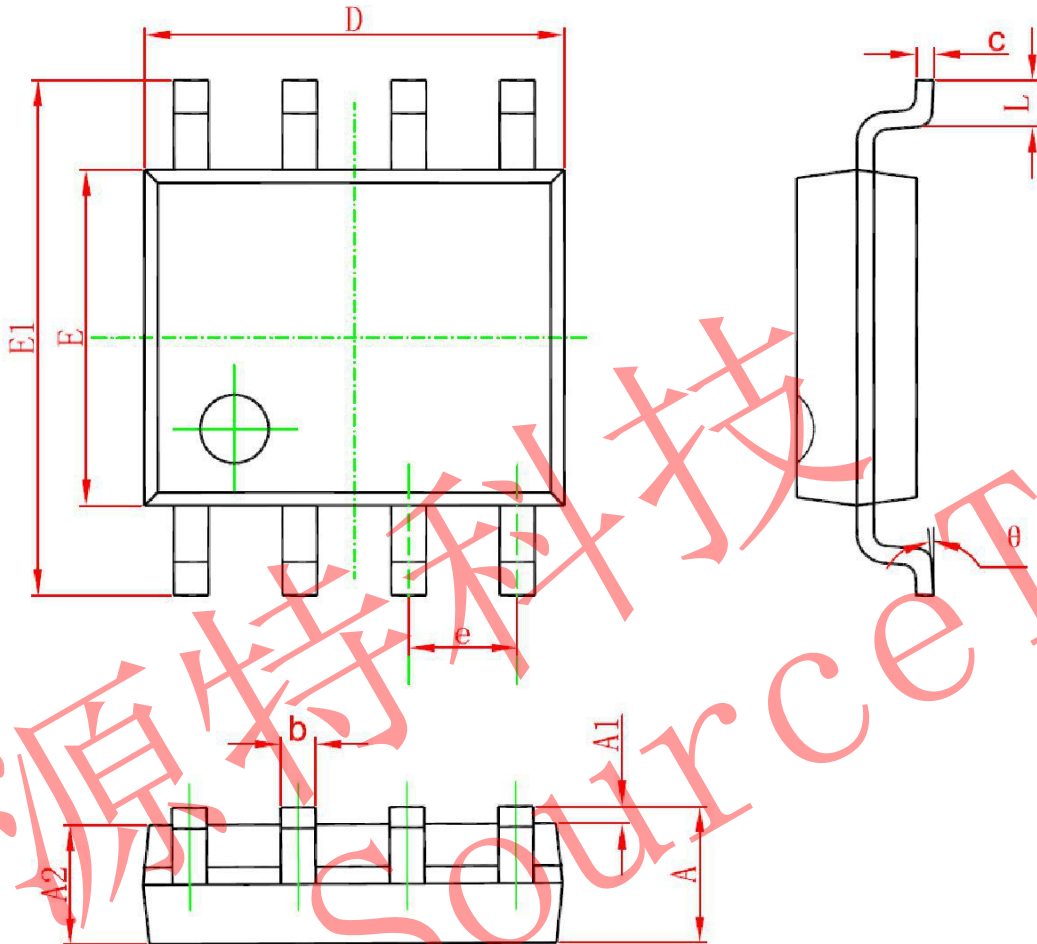

Symbol	Dimensions In Millimeters		Dimensions In Inches	
	Min	Max	Min	Max
A	1.350	1.750	0.053	0.069
A1	0.100	0.250	0.004	0.010
A2	1.350	1.550	0.053	0.061
b	0.330	0.510	0.013	0.020
c	0.170	0.250	0.006	0.010
D	4.700	5.100	0.185	0.200
E	3.800	4.000	0.150	0.157
E1	5.800	6.200	0.228	0.244
e	1.270 (BSC)		0.050 (BSC)	
L	0.400	1.270	0.016	0.050
$\theta$	0°	8°	0°	8°