



## N-Channel Enhancement Mode Power MOSFET

The MX8806B uses advanced trench technology to provide excellent  $R_{DS(ON)}$ , low gate charge and operation with gate voltages as low as 2.5V.

This device is suitable for use as a load switch or in PWM applications.

### General Features

- ◆  $V_{DS} = 15V, I_D = 6A$
- ◆  $R_{DS(ON)} < 15m\Omega @ V_{GS} = 4.5V$
- ◆  $R_{DS(ON)} < 17m\Omega @ V_{GS} = 3.8V$
- ◆  $R_{DS(ON)} < 22m\Omega @ V_{GS} = 2.5V$
- ◆ High Power and current handling capability
- ◆ Lead free product is acquired
- ◆ Surface Mount Package

### Applicatio

- ◆ PWM application
- ◆ Load switch

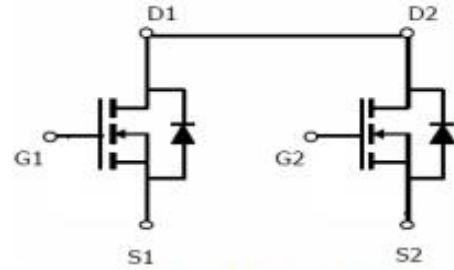

Schematic diagram

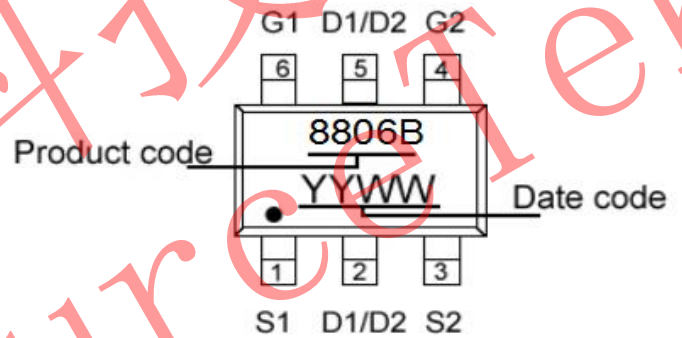

Marking and pin assignment  
SOT-23-6 (TOP VIEW)

### ASO Absolute Maximum Ratings (TA=25°C unless otherwise noted)

Parameter	Symbol	Limit	Unit
Drain-Source Voltage	$V_{DS}$	15	V
Gate-Source Voltage	$V_{GS}$	$\pm 10$	V
Drain Current-Continuous	$I_D$	5	A
Drain Current-Pulsed (Note 1)	$I_{DM}$	20	A
Maximum Power Dissipation	$P_D$	1.5	W
Operating Junction and Storage Temperature Range	$T_J, T_{STG}$	-55 To 150	°C



**Thermal Characteristic**

Thermal Resistance, Junction-to-Ambient (Note 2)	$R_{\theta JA}$	83.3	$^{\circ}C/W$
--	-----------------	------	---------------

**Electrical Characteristics (TA=25 $^{\circ}C$  unless otherwise noted)**

Parameter	Symbol	Condition	Min	Typ	Max	Unit
<b>Off Characteristics</b>						
Drain-Source Breakdown Voltage	$BV_{DSS}$	$V_{GS}=0V, I_D=250\mu A$	15	19	-	V
Zero Gate Voltage Drain Current	$I_{DSS}$	$V_{DS}=15V, V_{GS}=0V$	-	-	1	$\mu A$
Gate-Body Leakage Current	$I_{GSS}$	$V_{GS}=\pm 10V, V_{DS}=0V$	-	-	$\pm 100$	nA
<b>On Characteristics (Note 3)</b>						
Gate Threshold Voltage	$V_{GS(th)}$	$V_{DS}=V_{GS}, I_D=250\mu A$	0.45	0.7	0.95	V
Drain-Source On-State Resistance	$R_{DS(on)}$	$V_{GS}=4.5V, I_D=4.5A$	10	12.8	15	m $\Omega$
		$V_{GS}=3.8V, I_D=4.0A$	11	13.5	17	m $\Omega$
		$V_{GS}=2.5V, I_D=3.5A$	15.5	18.6	22	m $\Omega$
Forward Transconductance	$g_{FS}$	$V_{DS}=5V, I_D=5A$	-	20	-	S
<b>Dynamic Characteristics (Note4)</b>						
Input Capacitance	$C_{iss}$	$V_{DS}=10V, V_{GS}=0V,$ $F=1.0MHz$	-	1150	-	PF
Output Capacitance	$C_{oss}$		-	185	-	PF
Reverse Transfer Capacitance	$C_{rss}$		-	145	-	PF
<b>Switching Characteristics (Note 4)</b>						
Turn-on Delay Time	$t_{d(on)}$	$V_{DD}=10V, R_L=1.35\Omega$ $V_{GS}=5V, R_{GEN}=3\Omega$	-	6		nS
Turn-on Rise Time	$t_r$		-	13		nS
Turn-Off Delay Time	$t_{d(off)}$		-	52		nS
Turn-Off Fall Time	$t_f$		-	16		nS
Total Gate Charge	$Q_g$	$V_{DS}=10V, I_D=5A,$ $V_{GS}=4.5V$	-	15		nC
Gate-Source Charge	$Q_{gs}$		-	0.8	-	nC
Gate-Drain Charge	$Q_{gd}$		-	3.2	-	nC
<b>Drain-Source Diode Characteristics</b>						
Diode Forward Voltage (Note 3)	$V_{SD}$	$V_{GS}=0V, I_S=1A$	-	-	1.2	V
Diode Forward Current (Note 2)	$I_S$		-	-	7	A

**Notes:**

1. Repetitive Rating: Pulse width limited by maximum junction temperature.
  2. Surface Mounted on FR4 Board,  $t \leq 10$  sec.
  3. Pulse Test: Pulse Width  $\leq 300\mu s$ , Duty Cycle  $\leq 2\%$ .
- Guaranteed by design, not subject to production



TYPICAL ELECTRICAL AND THERMAL CHARACTERISTICS

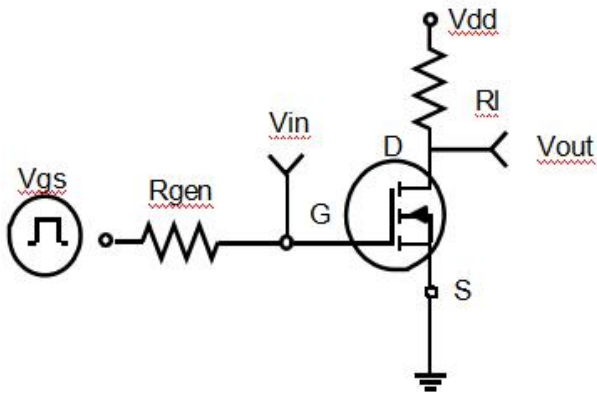

Figure 1: Switching Test Circuit

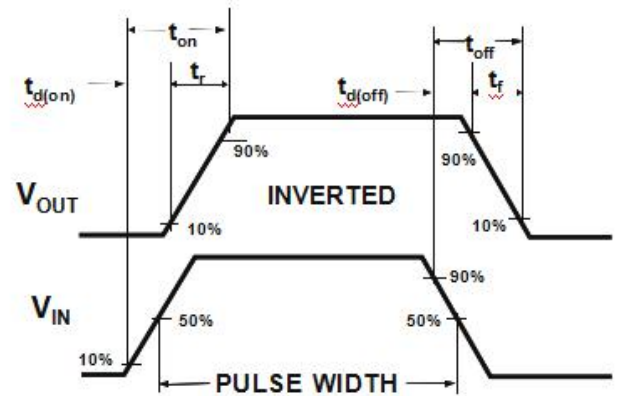

Figure 2: Switching Waveforms

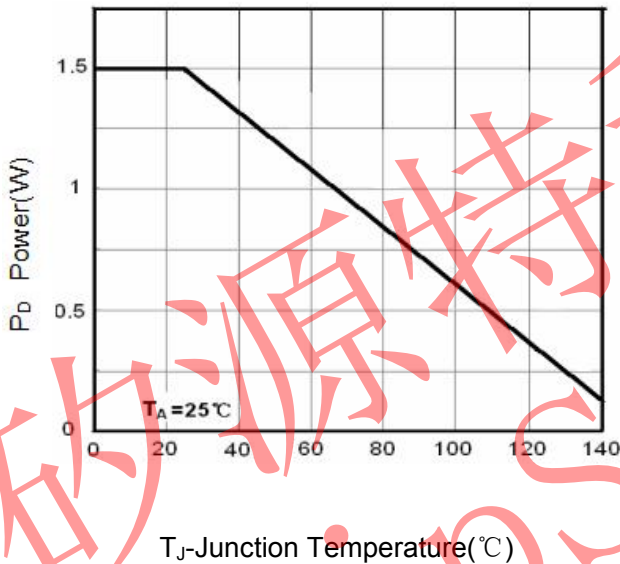

Figure 3 Power Dissipation

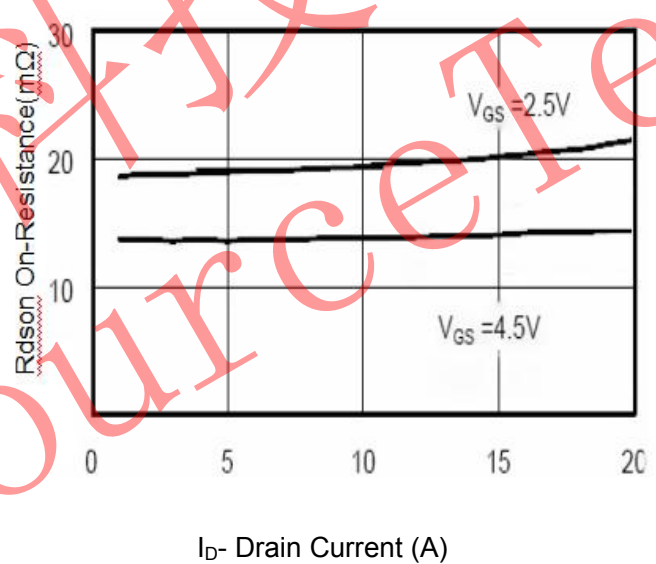
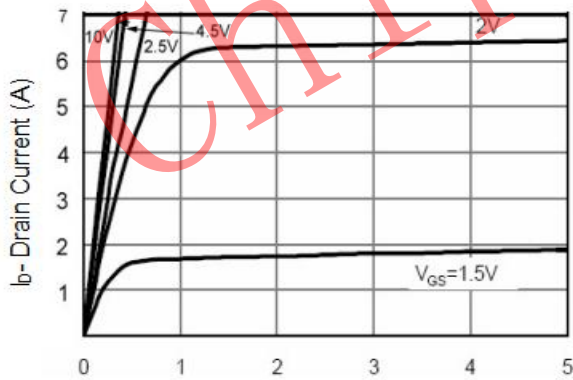
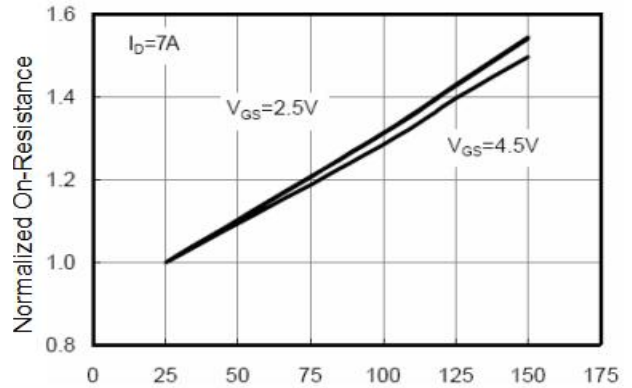

Figure 4 Drain-Source On-Resistance



V<sub>ds</sub> Drain-Source Voltage (V)

Figure 5 Output CHARACTERISTICS



T<sub>J</sub>-Junction Temperature (°C)

Figure 6 Drain-Source On-Resistance

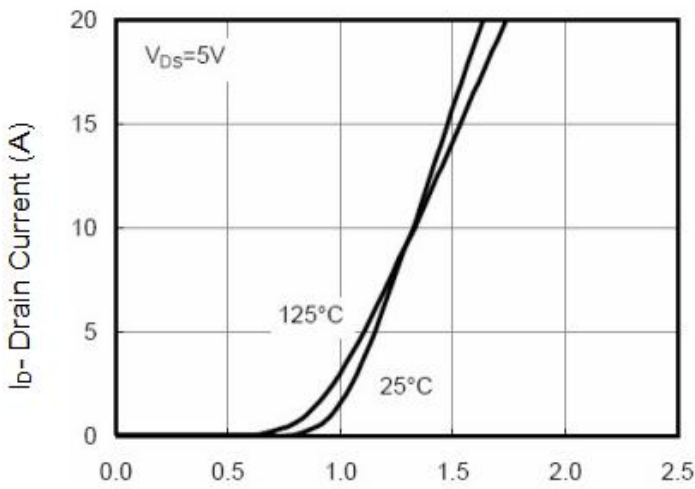

Vgs Gate-Source Voltage (V)  
**Figure 7 Transfer Characteristics**

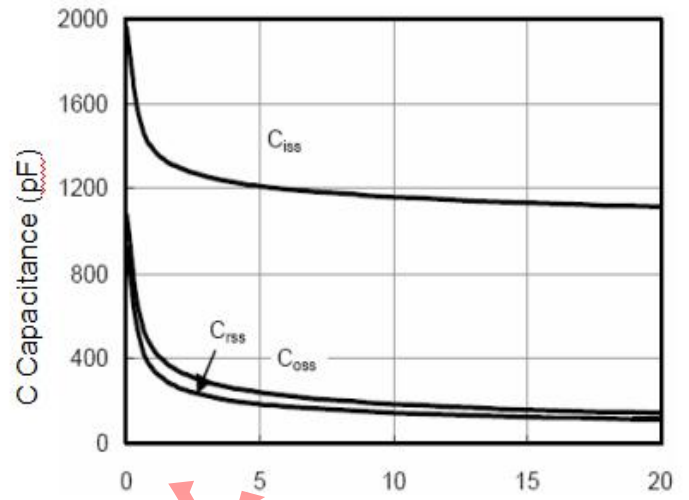

Vds Drain-Source Voltage (V)  
**Figure 8 Capacitance vs Vds**

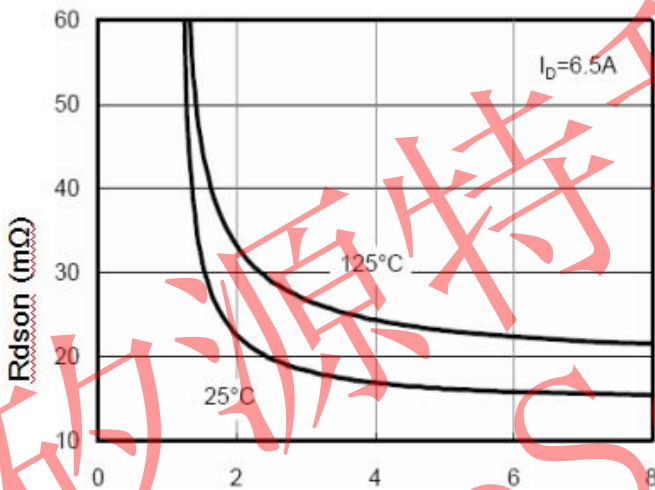

Vgs Gate-Source Voltage (V)  
**Figure 9 Rds(on) vs Vgs**

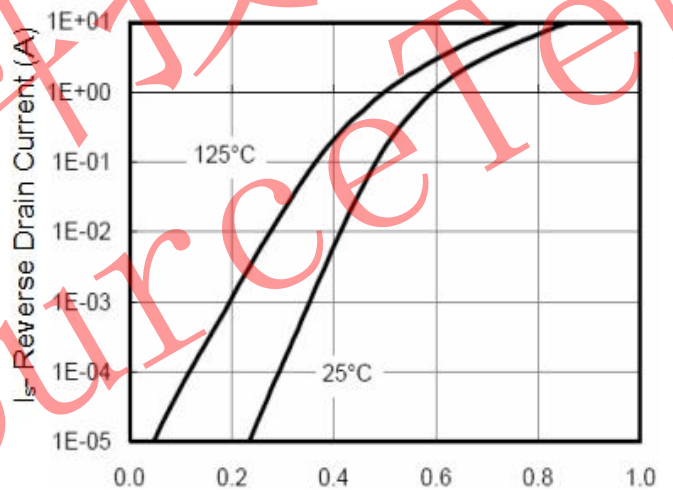

Vds Drain-Source Voltage (V)  
**Figure 10 Capacitance vs Vds**

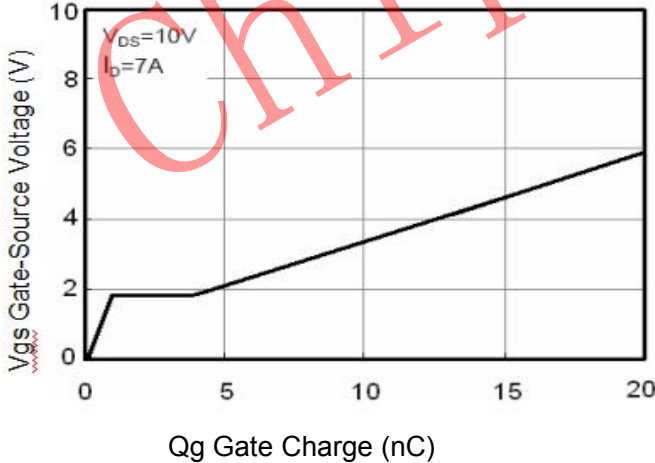

Qg Gate Charge (nC)  
**Figure 11 Gate Charge**

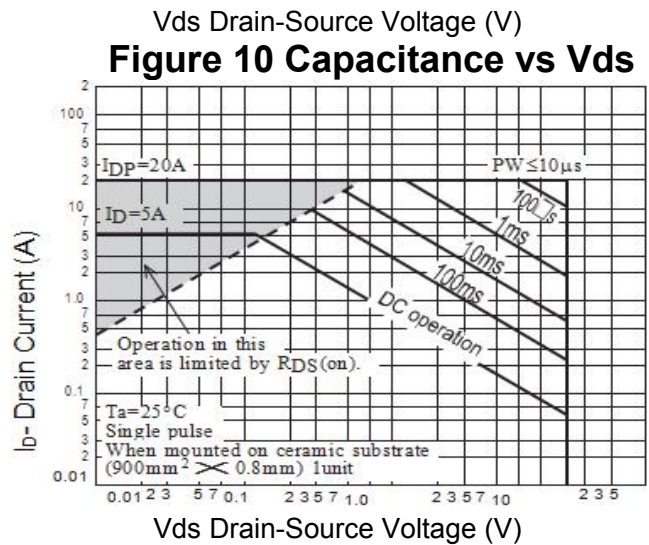

Vds Drain-Source Voltage (V)  
**Figure 12 Safe Operation Area**



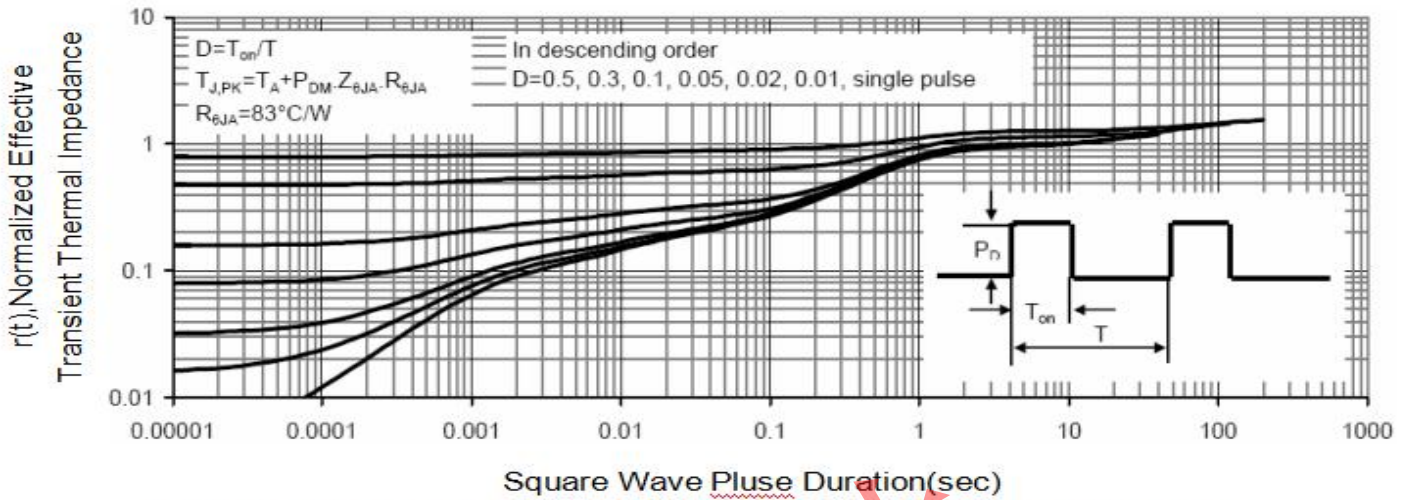

### SOT23-6 PACKAGE INFOR

