

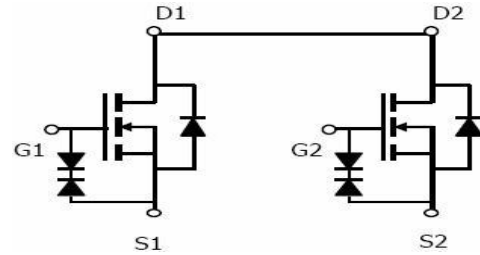

## Dual N-Channel Enhancement Mode Power MOSFET

### Description

The MXN2508 uses advanced trench technology to provide excellent  $R_{DS(ON)}$ , low gate charge and operation with gate voltages as low as 2.5V. This device is suitable for use as a load switch or in PWM applications. It is ESD protected.



Schematic diagram

### General Features

- ◆  $V_{DS} = 20V$ ,  $I_D = 8A$ 
  - @ $V_{GS} = 4.5V$   $R_{DS(ON)}$ (Typ.)=14m $\Omega$
  - @ $V_{GS} = 4.2V$   $R_{DS(ON)}$ (Typ.)=14.4m $\Omega$
  - @ $V_{GS} = 3.8V$   $R_{DS(ON)}$ (Typ.)=15.6m $\Omega$
  - @ $V_{GS} = 2.5V$   $R_{DS(ON)}$ (Typ.)=19m $\Omega$
- ◆ ESD Rating: 2000V HBM
- ◆ Advanced trench MOSFET process technology
- ◆ Ultra low on-resistance with low gate charge
- ◆ New Thermally Enhanced DFN2X5-6L Package

### Application

- ◆ PWM applications
- ◆ Load switch
- ◆ battery charge in cellular handset

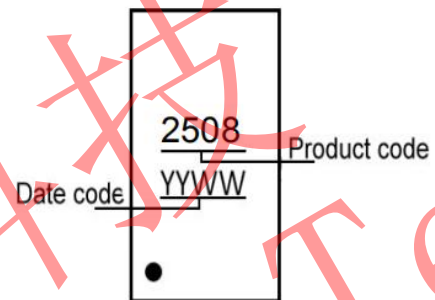

Marking Description

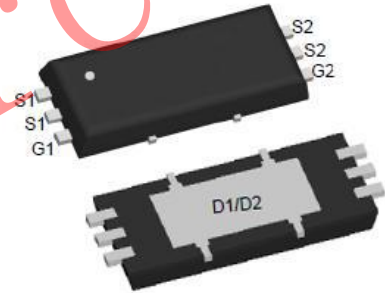

DFN2x5-6L Pin definition and Top / Bottom View

### Absolute Maximum Ratings (TA=25°C unless otherwise noted)

Parameter	Symbol	Limit	Unit
Drain-Source Voltage	$V_{DS}$	20	V
Gate-Source Voltage	$V_{GS}$	$\pm 12$	V
Drain Current-Continuous	$I_D$	8	A
Drain Current-Pulsed (Note 1)	$I_{DM}$	32	A
Maximum Power Dissipation	$P_D$	1.7	W
Operating Junction and Storage Temperature Range	$T_J, T_{STG}$	-55 To 150	°C



### Electrical Characteristics (TA=25°C unless otherwise noted)

Parameter	Symbol	Condition	Min	Typ	Max	Unit
<b>Off Characteristics</b>						
Drain-Source Breakdown Voltage	$BV_{DSS}$	$V_{GS}=0V, I_D=250\mu A$	20	-	-	V
Zero Gate Voltage Drain Current	$I_{DSS}$	$V_{DS}=20V, V_{GS}=0V$	-	-	1	$\mu A$
Gate-Body Leakage Current	$I_{GSS}$	$V_{GS}=\pm 10V, V_{DS}=0V$	-	-	$\pm 10$	$\mu A$
<b>On Characteristics (Note 3)</b>						
Gate Threshold Voltage	$V_{GS(th)}$	$V_{DS}=V_{GS}, I_D=250\mu A$	0.45	0.7	0.95	V
Drain-Source On-State Resistance	$R_{DS(on)}$	$V_{GS}=4.5V, I_D=6.5A$	12	14	16	m $\Omega$
		$V_{GS}=4.2V, I_D=6.5A$	12.5	14.4	17	m $\Omega$
		$V_{GS}=3.8V, I_D=5.5A$	13	15.6	18	m $\Omega$
		$V_{GS}=2.5V, I_D=5.5A$	17	19	22	m $\Omega$
Forward Transconductance	$g_{FS}$	$V_{DS}=5V, I_D=7A$	-	20	-	S
<b>Dynamic Characteristics (Note4)</b>						
Input Capacitance	$C_{iss}$	$V_{DS}=10V, V_{GS}=0V$ $F=1.0MHz$	-	1150	-	PF
Output Capacitance	$C_{oss}$		-	185	-	PF
Reverse Transfer Capacitance	$C_{rss}$		-	145	-	PF
<b>Switching Characteristics (Note 4)</b>						
Turn-on Delay Time	$t_{d(on)}$	$V_{DD}=10V, R_L=1.35\Omega$ $V_{GS}=5V, R_{GEN}=3\Omega$	-	6	-	nS
Turn-on Rise Time	$t_r$		-	13	-	nS
Turn-Off Delay Time	$t_{d(off)}$		-	52	-	nS
Turn-Off Fall Time	$t_f$		-	16	-	nS
Total Gate Charge	$Q_g$	$V_{DS}=10V, I_D=7A,$ $V_{GS}=4.5V$	-	15	-	nC
Gate-Source Charge	$Q_{gs}$		-	0.8	-	nC
Gate-Drain Charge	$Q_{gd}$		-	3.2	-	nC
<b>Drain-Source Diode Characteristics</b>						
Diode Forward Voltage (Note 3)	$V_{SD}$	$V_{GS}=0V, I_S=1A$	-	-	1.2	V
Diode Forward Current (Note 2)	$I_S$		-	-	7	A

#### Notes:

- surface mounted on FR4 board,  $t \leq 10sec$
- pulse test: pulse width  $\leq 300\mu s$ , duty  $\leq 2\%$
- guaranteed by design, not subject to production testing



### TYPICAL ELECTRICAL AND THERMAL CHARACTERISTICS

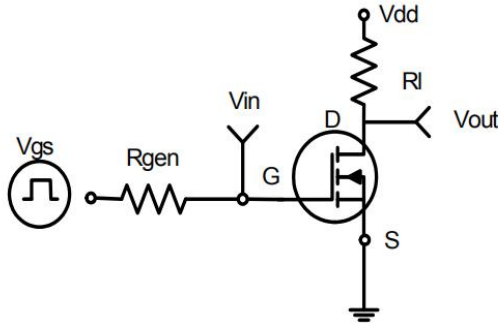

Figure 1: Switching Test Circuit

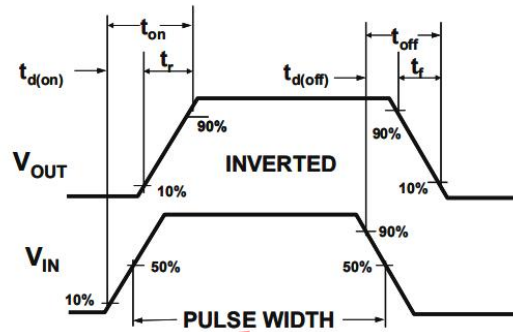

Figure 2: Switching Waveforms

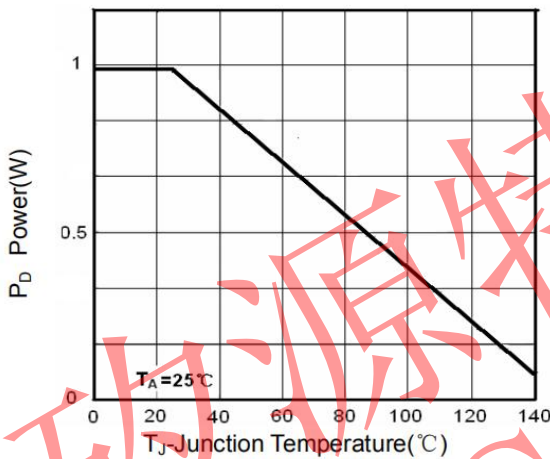

Figure 3 Power Dissipation

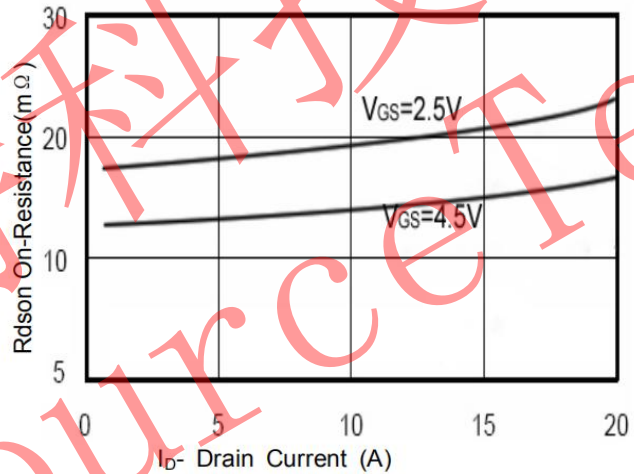

Figure 4 Drain-Source On-Resistance

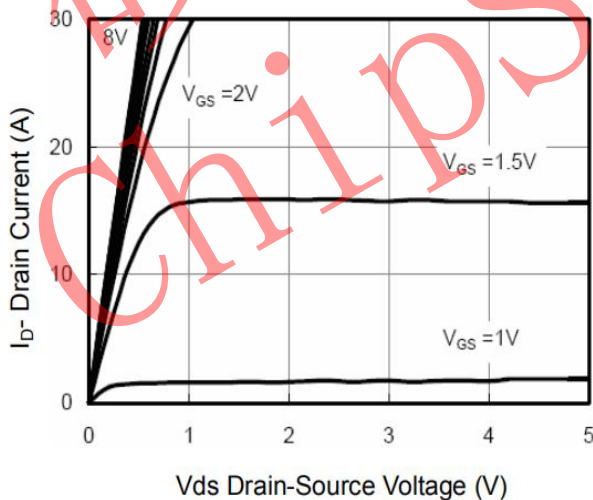

Figure 5 Output CHARACTERISTICS

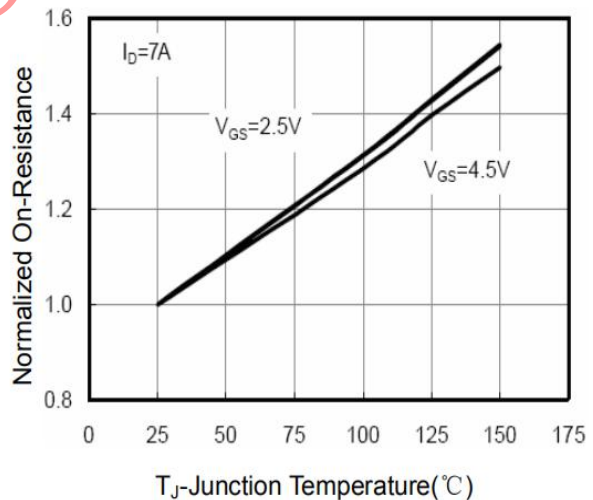
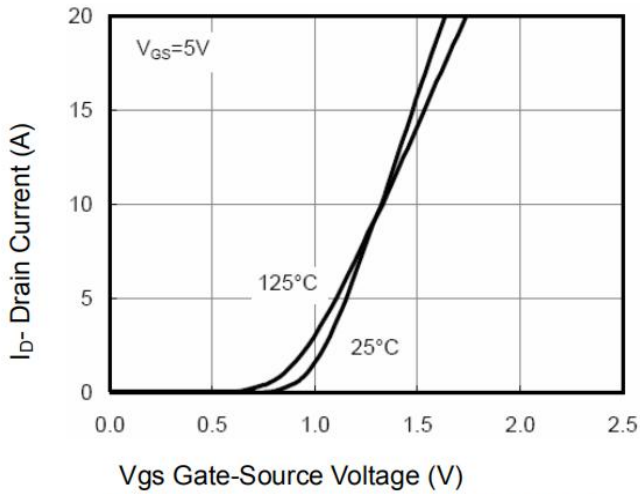
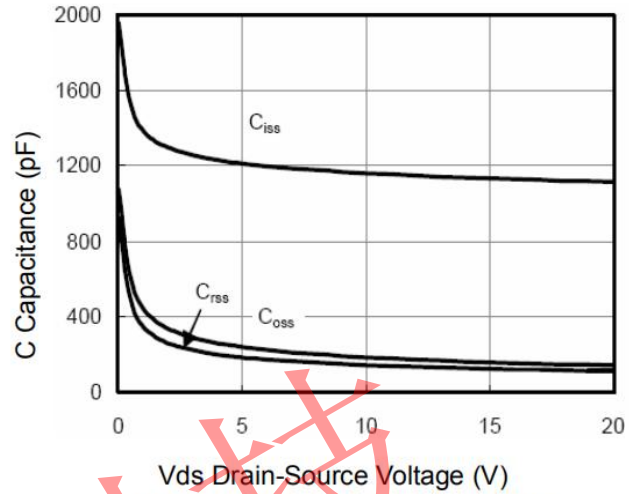

Figure 6 Drain-Source On-Resistance



Vgs Gate-Source Voltage (V)  
**Figure 7 Transfer Characteristics**



Vds Drain-Source Voltage (V)  
**Figure 8 Capacitance vs Vds**

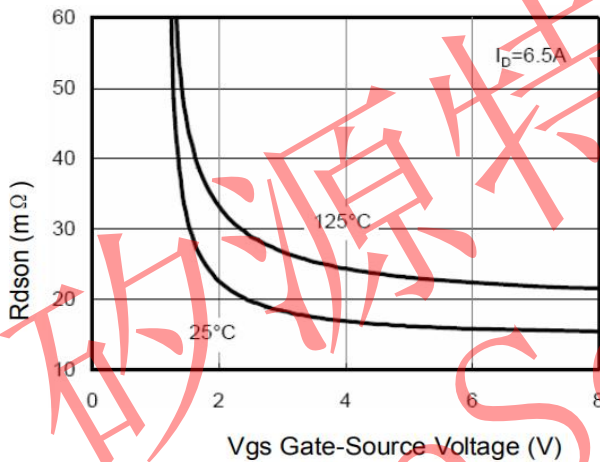

Vgs Gate-Source Voltage (V)  
**Figure 9 Rdson vs Vgs**

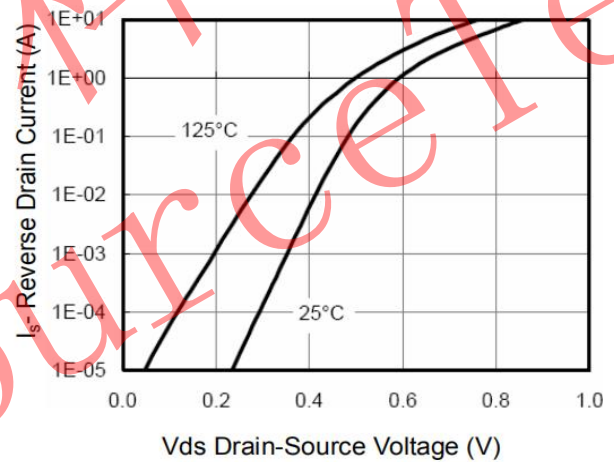

Vds Drain-Source Voltage (V)  
**Figure 10 Capacitance vs Vds**

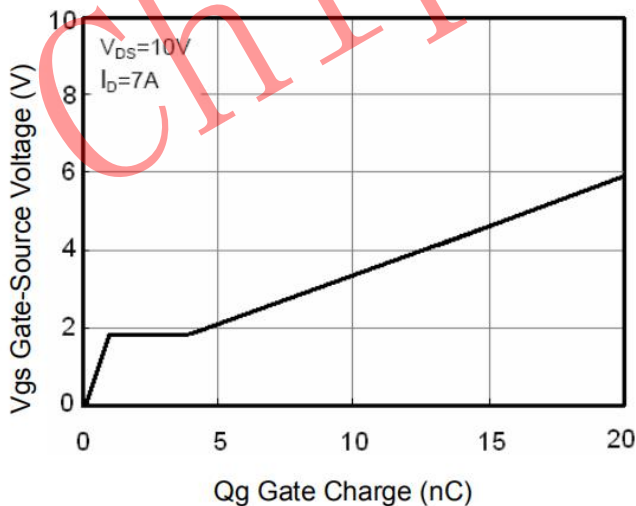

Qg Gate Charge (nC)  
**Figure 11 Gate Charge**

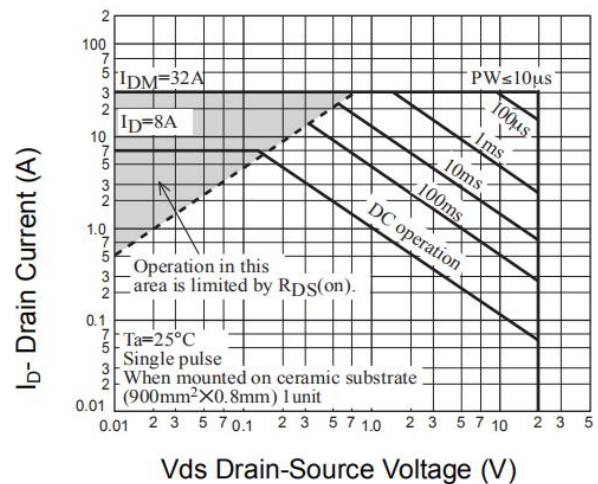

Vds Drain-Source Voltage (V)  
**Figure 12 Safe Operation Area**



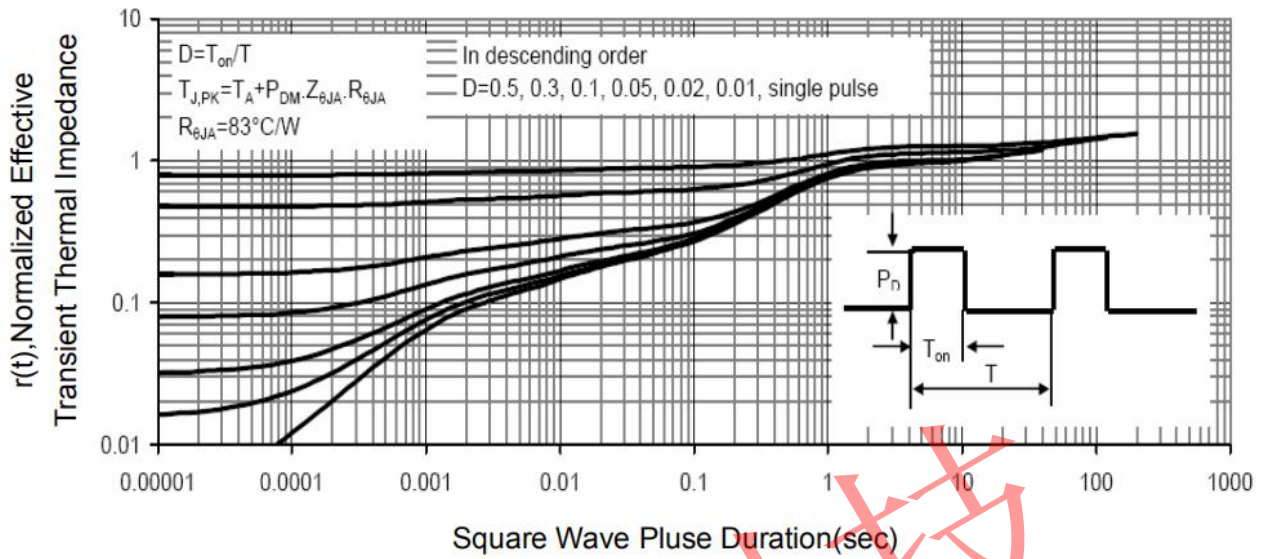

矽源特科技  
ChipSourceTek



### DFN2X5-6L PACKAGE OUTLINE DIMENSIONS

DFNWB2×5-6L (P0. 50T0. 75/0. 85) PACKAGE OUTLINE DIMENSIONS

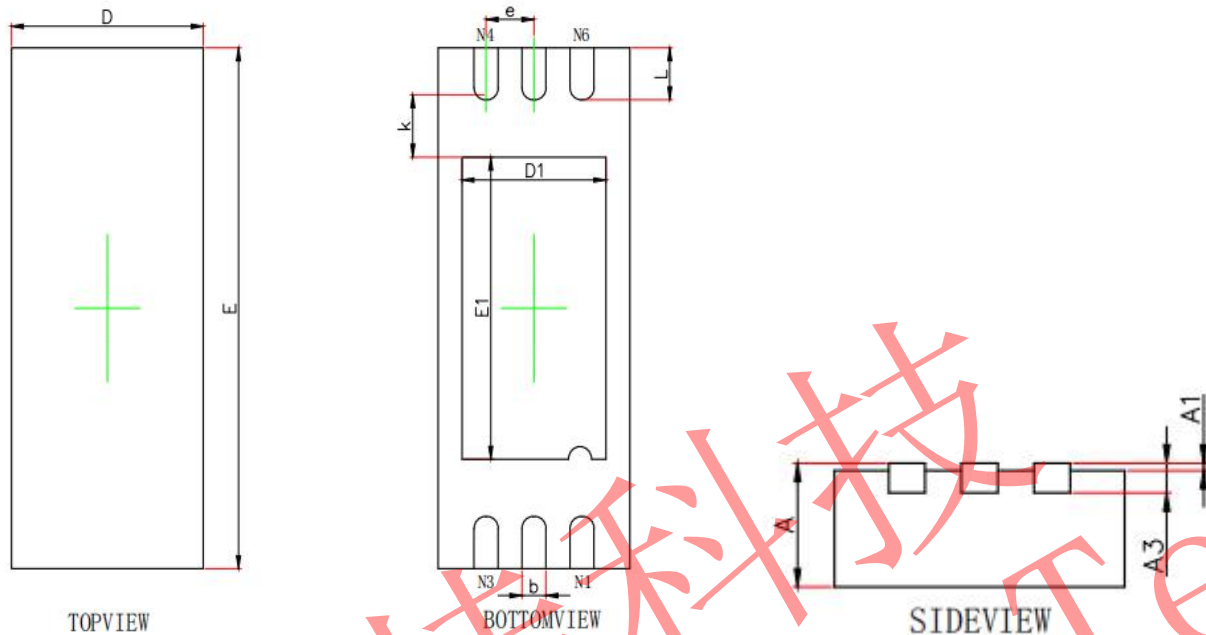

Symbol	Dimensions In Millimeters		Dimensions In Inches	
	Min.	Max.	Min.	Max.
A	0.700/0.800	0.800/0.900	0.028/0.031	0.031/0.035
A1	0.000	0.050	0.000	0.002
A3	0.203REF.		0.008REF.	
D	1.924	2.076	0.076	0.082
E	4.924	5.076	0.194	0.200
D1	1.400	1.600	0.055	0.063
E1	2.800	3.000	0.110	0.118
k	0.200MIN.		0.008MIN.	
b	0.200	0.300	0.008	0.012
e	0.500TYP.		0.020TYP.	
L	0.374	0.526	0.015	0.021