

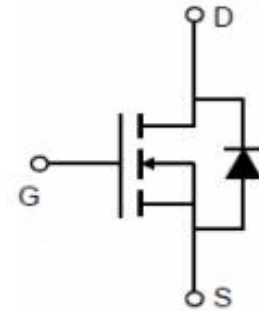

N-Channel Enhancement Mode Power MOSFET

Description

The MXN3050G uses advanced trench technology and design to provide excellent $R_{DS(ON)}$, With low gate charge. It can be used in a wide variety of applications.



General Features

$V_{DS} = 30V, I_D = 50A$

$R_{DS(ON)} < 9m\Omega @ V_{GS}=10V$

$R_{DS(ON)} < 13m\Omega @ V_{GS}=-4.5V$

Low density cell design

Fully characterized avalanche voltage and current

Good stability and uniformity with high E_{AS}

Excellent package for good heat dissipation

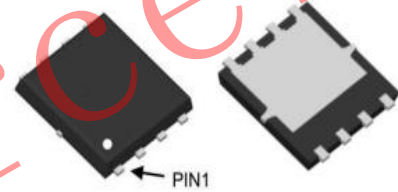
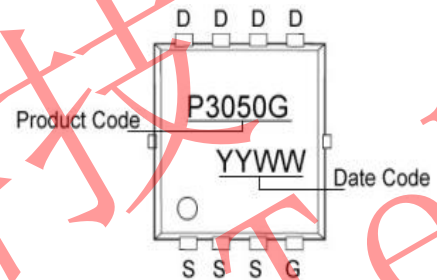

DFN5X6-8L top&bottom view

Application

Power switching application

Hard switched and high frequency circuits

Uninterruptible power supply

Absolute Maximum Ratings ($T_A=25^\circ C$ unless otherwise noted)

Parameter	Symbol	Limit	Unit
Drain-Source Voltage	V_{DS}	30	V
Gate-Source Voltage	V_{GS}	± 20	V
Drain Current-Continuous	I_D	50	A
Drain Current-Pulsed (Note 1)	I_{DM}	140	A
Maximum Power Dissipation	P_D	31	W
Operating Junction and Storage Temperature Range	T_J, T_{STG}	-55 To 150	$^\circ C$

Thermal Characteristic

Thermal Resistance, Junction-to-Ambient (Note 2)	$R_{\theta JA}$	4.0	$^\circ C/W$
--	-----------------	-----	--------------



Electrical Characteristics (T_A=25°C unless otherwise noted)

Parameter	Symbol	Condition	Min	Typ	Max	Unit
Drain-Source Breakdown Voltage	BV _{DSS}	V _{GS} =0V, I _D =-250μA	30	-	-	V
Zero Gate Voltage Drain Current	I _{DSS}	V _{DS} =-24V, V _{GS} =0V	-	-	1	μA
Gate-Body Leakage Current	I _{GSS}	V _{GS} =±20V, V _{DS} =0V	-	-	±100	nA
On Characteristics (Note 3)						
Gate Threshold Voltage	V _{GS(th)}	V _{DS} =V _{GS} , I _D =250μA	1.0	1.4	2.0	V
Drain-Source On-State Resistance	R _{DS(ON)}	V _{GS} =10V, I _D =20A	-	7.3	9	mΩ
		V _{GS} =4.5V, I _D =20A	-	9.3	13.0	mΩ
Forward Transconductance	g _{FS}	V _{DS} =5V, I _D =20A	-	70	-	S
Dynamic Characteristics (Note 4)						
Input Capacitance	C _{ISS}	V _{DS} =15V, V _{GS} =0V, F=1.0MHz	-	1200	-	PF
Output Capacitance	C _{OSS}		-	190	-	PF
Reverse Transfer Capacitance	C _{rss}		-	110	-	PF
Switching Characteristics (Note 4)						
Turn-on Delay Time	t _{d(on)}	V _{DD} =15V, R _L =15Ω V _{GS} =10V, R _G =2.5Ω	-	6.5	-	nS
Turn-on Rise Time	t _r		-	2	-	nS
Turn-Off Delay Time	t _{d(off)}		-	18	-	nS
Turn-Off Fall Time	t _f		-	4	-	nS
Total Gate Charge	Q _g		V _{DS} =15V, I _D =20A, V _{GS} =10V	-	10	-
Gate-Source Charge	Q _{gs}	-		3	-	nC
Gate-Drain Charge	Q _{gd}	-		5	-	nC
Drain-Source Diode Characteristics						
Diode Forward Voltage (Note 3)	V _{SD}	V _{GS} =0V, I _S =20A	-	-	1.2	V
Diode Forward Current (Note 2)	I _S		-	-	60	A
Reverse Recovery Time	t _{rr}	T _J = 25°C, I _F = 20A di/dt = 100A/μs (Note 3)	-	26	-	nS
Reverse Recovery Charge	Q _{rr}		-	34	-	nC
Forward Turn-On Time	t _{on}	Intrinsic turn-on time is negligible (turn-on is dominated by LS+LD)				

Notes:

1. Repetitive Rating: Pulse width limited by maximum junction temperature.
2. Surface Mounted on FR4 Board, t ≤ 10 sec.
3. Pulse Test: Pulse Width ≤ 300μs, Duty Cycle ≤ 2%.
4. Guaranteed by design, not subject to production



Test circuit

1) E_{AS} Test Circuit

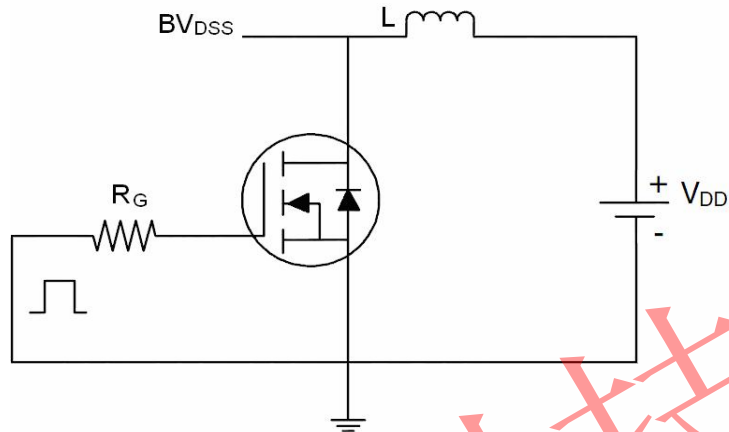

2) Gate Charge Test Circuit

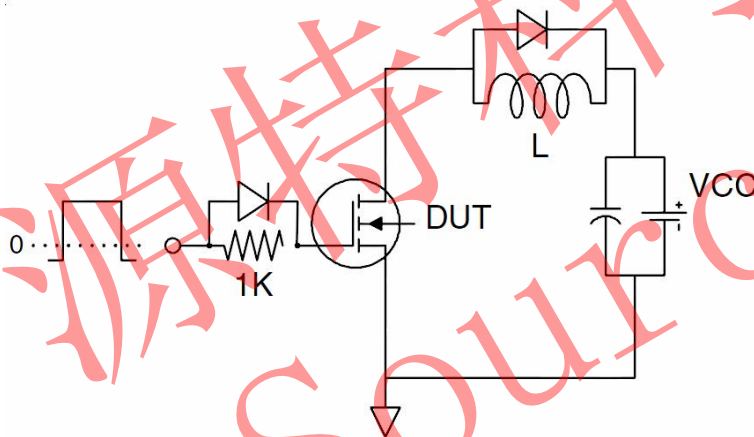

3) Switch Time Test Circuit

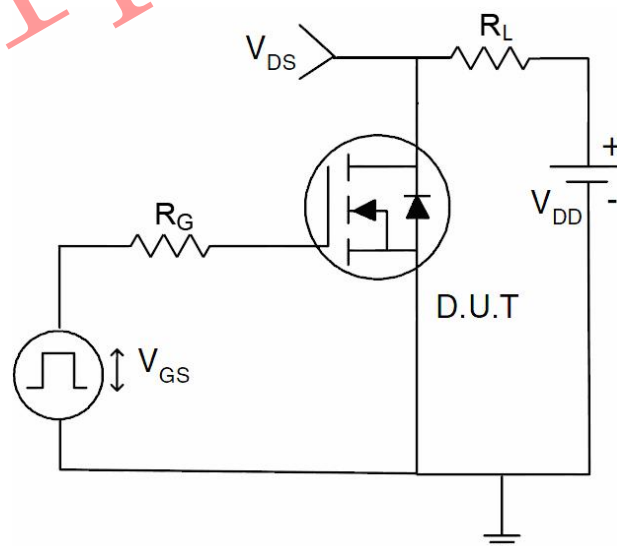



Typical Electrical and Thermal Characteristics (Curves)

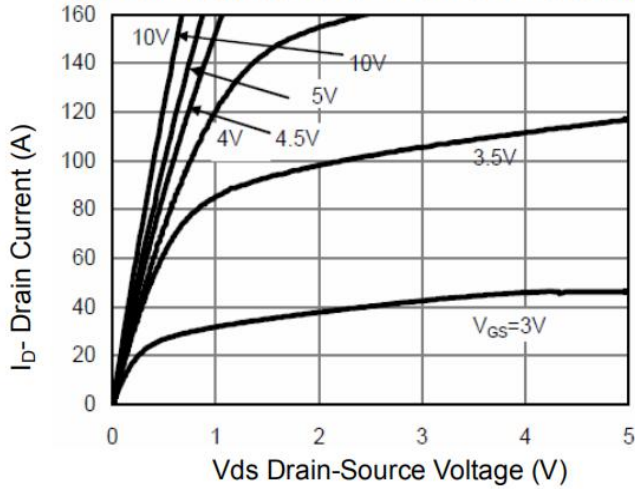

Figure 1 Output Characteristics

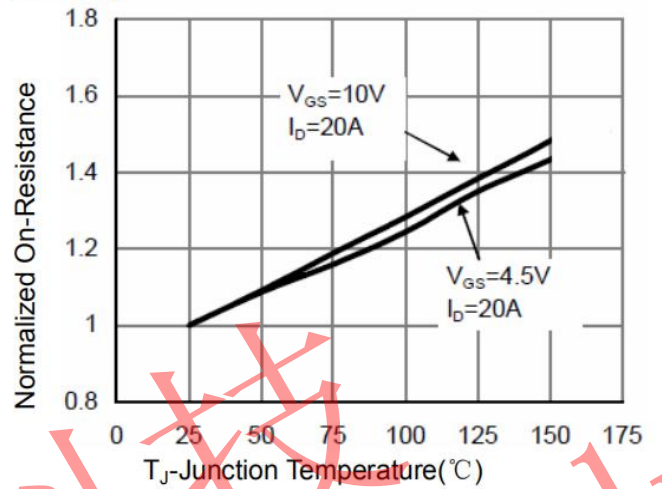

Figure 4 R_{dson} -Junction Temperature

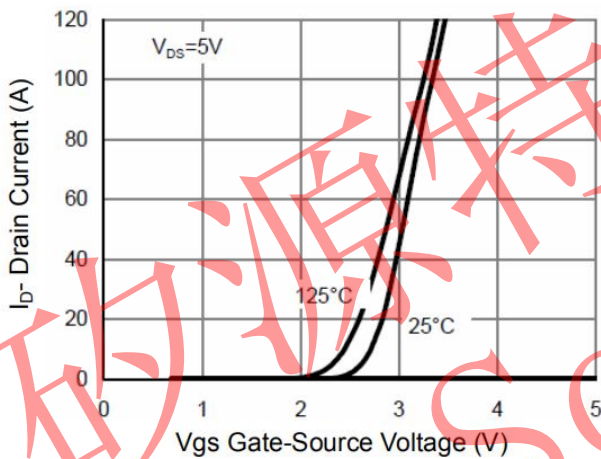

Figure 2 Transfer Characteristics

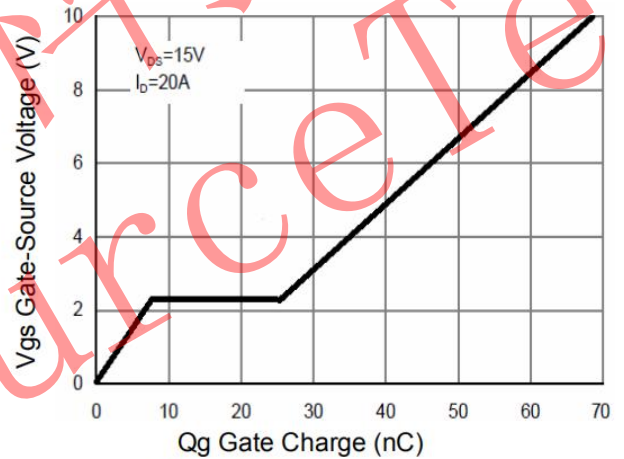

Figure 5 Gate Charge

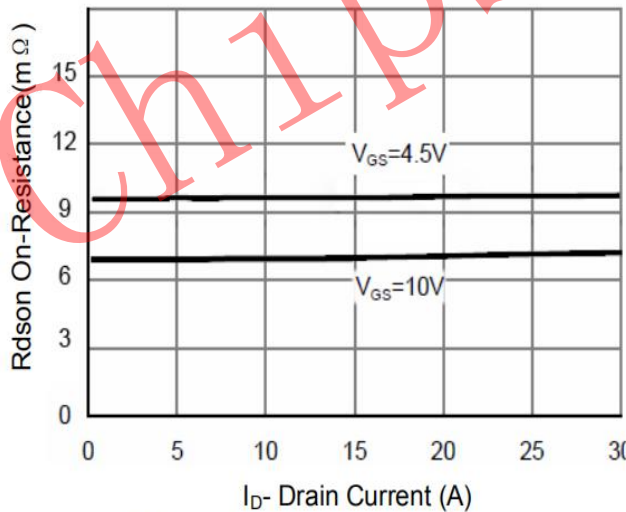

Figure 3 R_{dson} - Drain Current

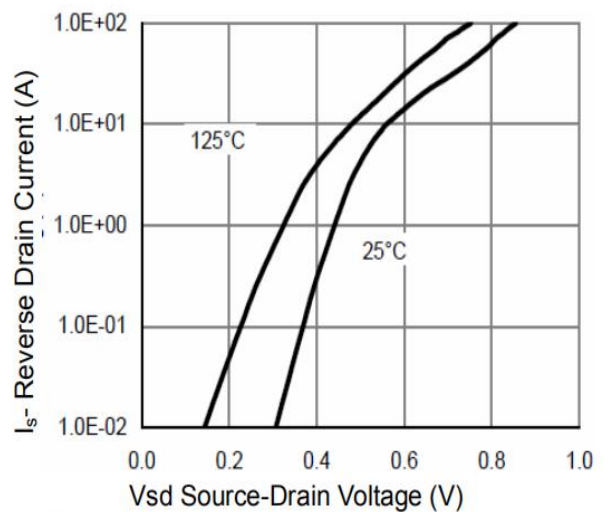

Figure 6 Source- Drain Diode Forward

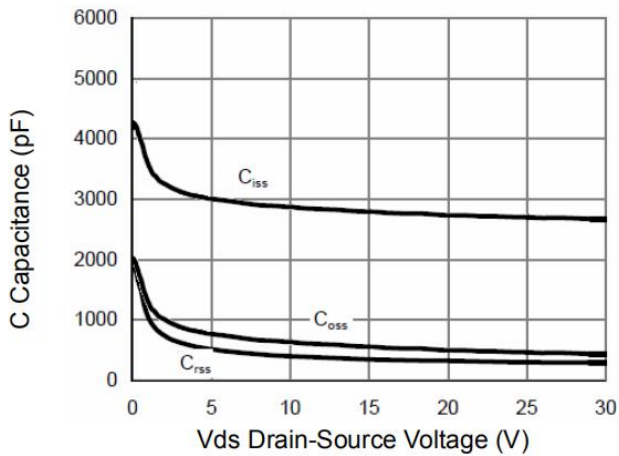

Figure 7 Capacitance vs Vds

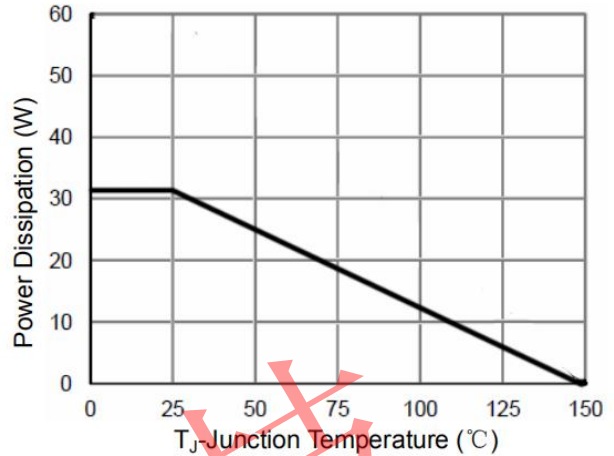

Figure 9 Power De-rating

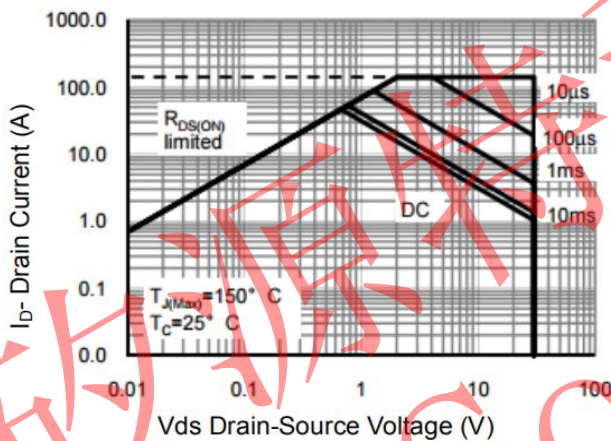

Figure 8 Safe Operation Area

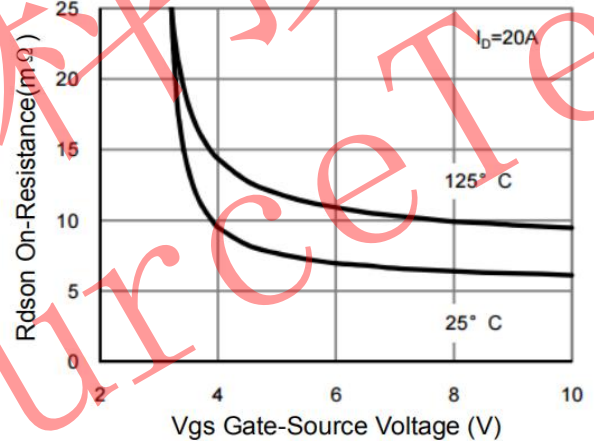

Figure 10 Rds(on) vs Gate-Source Voltage

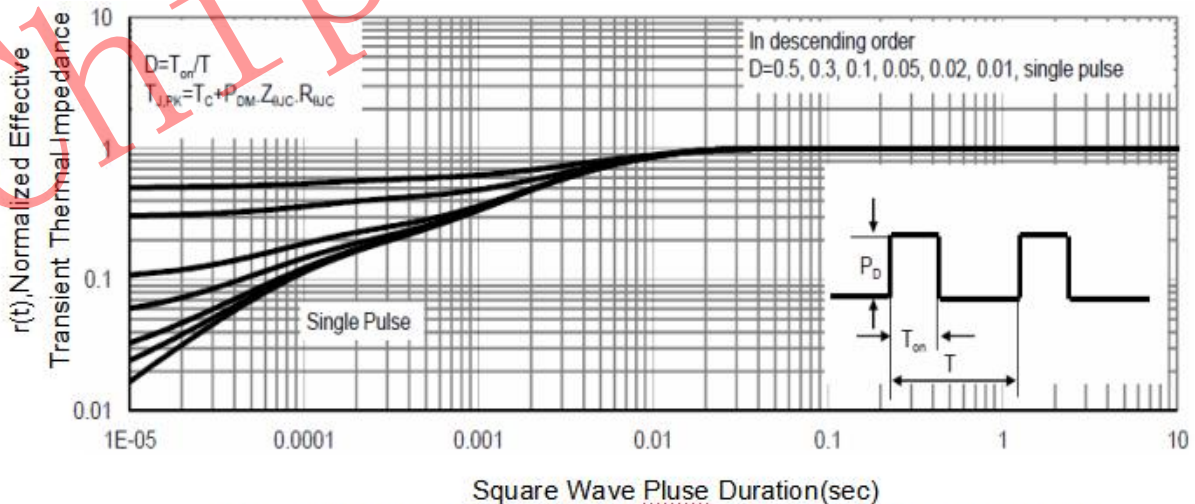
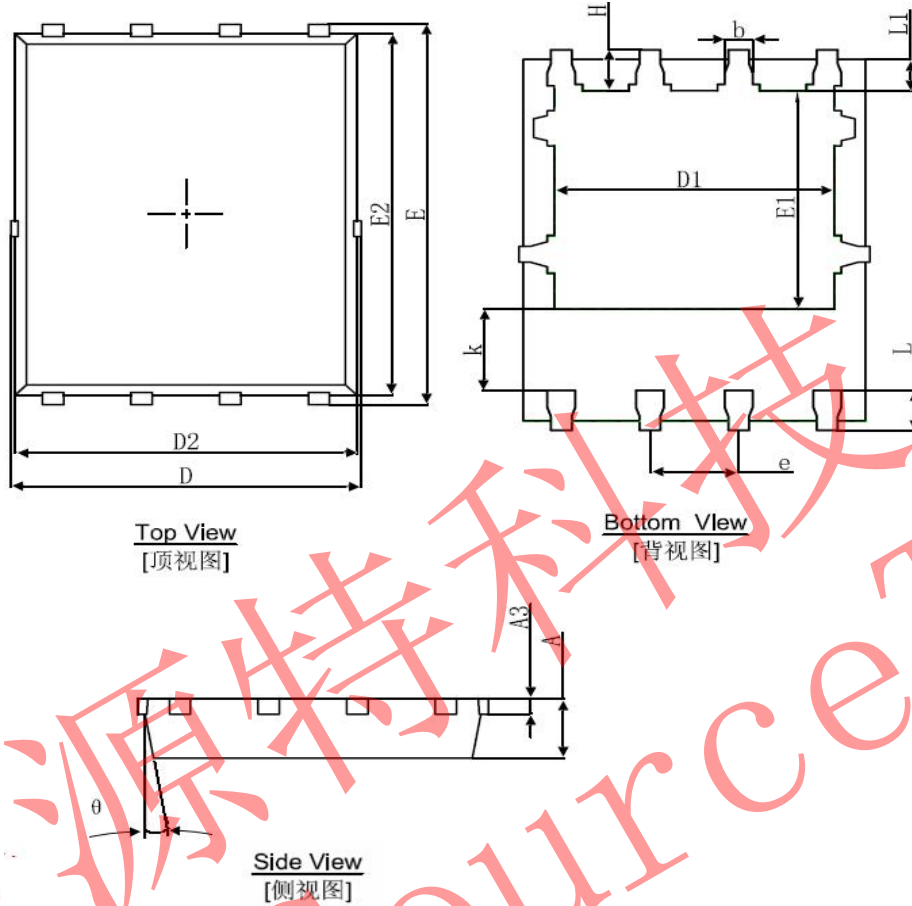

Figure 11 Normalized Maximum Transient Thermal Impedance



DFN5X6-8L Package Information



Symbol	Dimensions In Millimeters		Dimensions In Inches	
	Min.	Max.	Min.	Max.
A	0.900	1.000	0.035	0.039
A3	0.254REF.		0.010REF.	
D	4.944	5.096	0.195	0.201
E	5.974	6.126	0.235	0.241
D1	3.910	4.110	0.154	0.162
E1	3.375	3.575	0.133	0.141
D2	4.824	4.976	0.190	0.196
E2	5.674	5.826	0.223	0.229
k	1.190	1.390	0.047	0.055
b	0.350	0.450	0.014	0.018
e	1.270TYP.		0.050TYP.	
L	0.559	0.711	0.022	0.028
L1	0.424	0.576	0.017	0.023
H	0.574	0.726	0.023	0.029
θ	8°	12°	8°	12°