

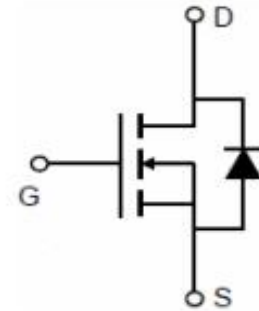

### N-Channel Enhancement Mode Power MOSFET

#### Description

The MXN3060 uses advanced trench technology and design to provide excellent  $R_{DS(ON)}$ , With low gate charge. It can be used in a wide variety of applications.



#### General Features

$V_{DS} = 30V, I_D = 80A$

$R_{DS(ON)}$  (Typ.)  $5.0m\Omega @ V_{GS}=10V$

$R_{DS(ON)}$  (Typ.)  $6m\Omega @ V_{GS}=-4.5V$

Low density cell design  
Fully characterized avalanche voltage and current

Good stability and uniformity with high  $E_{AS}$   
Excellent package for good heat dissipation

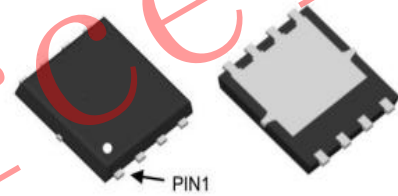
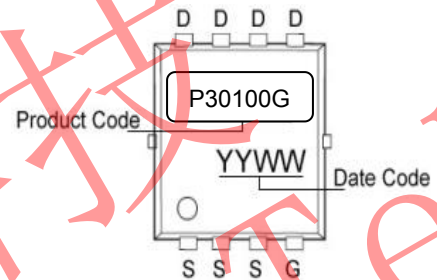

DFN5X6-8L top&bottom view

#### Application

- Power switching application
- Hard switched and high frequency circuits
- Uninterruptible power supply

#### Absolute Maximum Ratings ( $T_A=25^\circ C$ unless otherwise noted)

| Parameter  | Symbol         | Limit      | Unit       |
|--|----------------|------------|------------|
| Drain-Source Voltage                             | $V_{DS}$       | 30         | V          |
| Gate-Source Voltage                              | $V_{GS}$       | $\pm 20$   | V          |
| Drain Current-Continuous                         | $I_D$          | 80         | A          |
| Drain Current-Pulsed (Note 1)                    | $I_{DM}$       | 150        | A          |
| Maximum Power Dissipation                        | $P_D$          | 42         | W          |
| Operating Junction and Storage Temperature Range | $T_J, T_{STG}$ | -55 To 150 | $^\circ C$ |

#### Thermal CharacteristicE

|  |                 |     |              |
|--|-----------------|-----|--------------|
| Thermal Resistance, Junction-to-Ambient (Note 2) | $R_{\theta JA}$ | 3.0 | $^\circ C/W$ |
|--|-----------------|-----|--------------|



**Electrical Characteristics (T<sub>A</sub>=25°C unless otherwise noted)**

| Parameter                                 | Symbol              | Condition   | Min | Typ  | Max  | Unit |
|---|---------------------|---|-----|------|------|------|
| Drain-Source Breakdown Voltage            | BV <sub>DSS</sub>   | V <sub>GS</sub> =0V, I <sub>D</sub> =-250μA   | 30  | -    | -    | V    |
| Zero Gate Voltage Drain Current           | I <sub>DSS</sub>    | V <sub>DS</sub> =-24V, V <sub>GS</sub> =0V  | -   | -    | 1    | μA   |
| Gate-Body Leakage Current                 | I <sub>GSS</sub>    | V <sub>GS</sub> =±20V, V <sub>DS</sub> =0V  | -   | -    | ±100 | nA   |
| <b>On Characteristics</b> (Note 3)        |                     |   |     |      |      |      |
| Gate Threshold Voltage                    | V <sub>GS(th)</sub> | V <sub>DS</sub> =V <sub>GS</sub> , I <sub>D</sub> =250μA                                | 1.0 | 1.4  | 2.0  | V    |
| Drain-Source On-State Resistance          | R <sub>DS(ON)</sub> | V <sub>GS</sub> =10V, I <sub>D</sub> =20A   | -   | 5.0  | 6.5  | mΩ   |
|   |                     | V <sub>GS</sub> =4.5V, I <sub>D</sub> =20A  | -   | 6.0  | 9.0  | mΩ   |
| Forward Transconductance                  | g <sub>FS</sub>     | V <sub>DS</sub> =5V, I <sub>D</sub> =20A  | -   | 57   | -    | S    |
| <b>Dynamic Characteristics</b> (Note 4)   |                     |   |     |      |      |      |
| Input Capacitance                         | C <sub>iss</sub>    | V <sub>DS</sub> =15V, V <sub>GS</sub> =0V,<br>F=1.0MHz                                  | -   | 1950 | -    | PF   |
| Output Capacitance                        | C <sub>oss</sub>    |   | -   | 310  | -    | PF   |
| Reverse Transfer Capacitance              | C <sub>rss</sub>    |   | -   | 240  | -    | PF   |
| <b>Switching Characteristics</b> (Note 4) |                     |   |     |      |      |      |
| Turn-on Delay Time                        | t <sub>d(on)</sub>  | V <sub>DD</sub> =15V, R <sub>L</sub> =15Ω<br>V <sub>GS</sub> =10V, R <sub>G</sub> =2.5Ω | -   | 8.1  | -    | nS   |
| Turn-on Rise Time                         | t <sub>r</sub>      |   | -   | 8.6  | -    | nS   |
| Turn-Off Delay Time                       | t <sub>d(off)</sub> |   | -   | 30   | -    | nS   |
| Turn-Off Fall Time                        | t <sub>f</sub>      |   | -   | 9    | -    | nS   |
| Total Gate Charge                         | Q <sub>g</sub>      |   | -   | 37   | -    | nC   |
| Gate-Source Charge                        | Q <sub>gs</sub>     | V <sub>DS</sub> =15V, I <sub>D</sub> =20A, V <sub>GS</sub> =10V                         | -   | 4.8  | -    | nC   |
| Gate-Drain Charge                         | Q <sub>gd</sub>     |   | -   | 11   | -    | nC   |
| <b>Drain-Source Diode Characteristics</b> |                     |   |     |      |      |      |
| Diode Forward Voltage (Note 3)            | V <sub>SD</sub>     | V <sub>GS</sub> =0V, I <sub>S</sub> =20A  | -   | -    | 1.2  | V    |
| Diode Forward Current (Note 2)            | I <sub>S</sub>      |   | -   | -    | 60   | A    |
| Reverse Recovery Time                     | t <sub>rr</sub>     | T <sub>J</sub> = 25°C, I <sub>F</sub> = 20A<br>di/dt = 100A/μs (Note 3)                 | -   | 26   | -    | nS   |
| Reverse Recovery Charge                   | Q <sub>rr</sub>     |   | -   | 34   | -    | nC   |
| Forward Turn-On Time                      | t <sub>on</sub>     | Intrinsic turn-on time is negligible (turn-on is dominated by LS+LD)                    |     |      |      |      |

**Notes:**

1. Repetitive Rating: Pulse width limited by maximum junction temperature.
2. Surface Mounted on FR4 Board, t ≤ 10 sec.
3. Pulse Test: Pulse Width ≤ 300μs, Duty Cycle ≤ 2%.
4. Guaranteed by design, not subject to production



## Test circuit

### 1) $E_{AS}$ Test Circuit

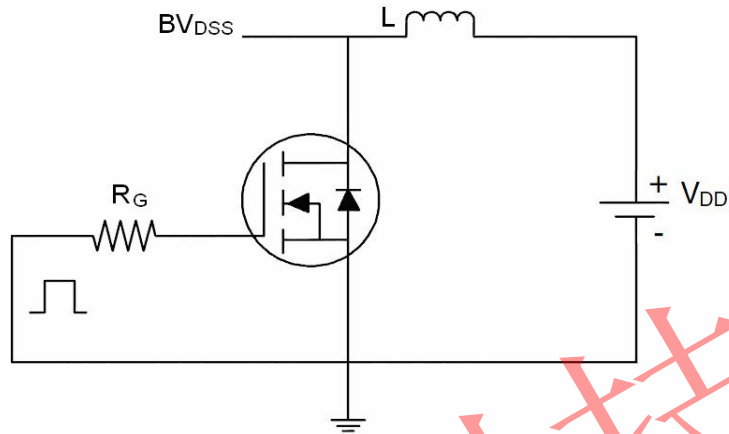

### 2) Gate Charge Test Circuit

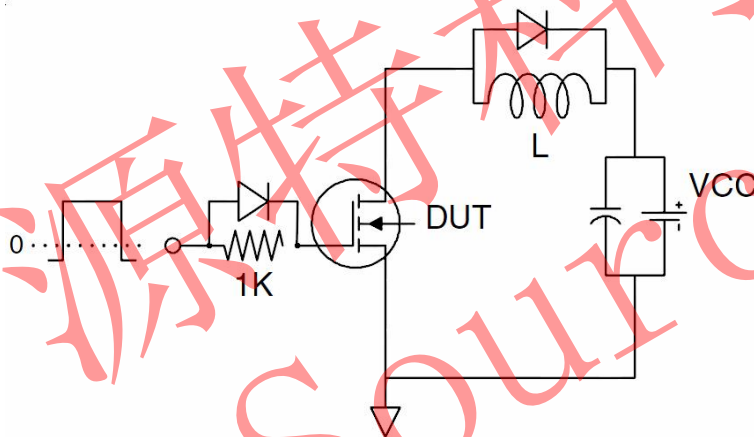

### 3) Switch Time Test Circuit

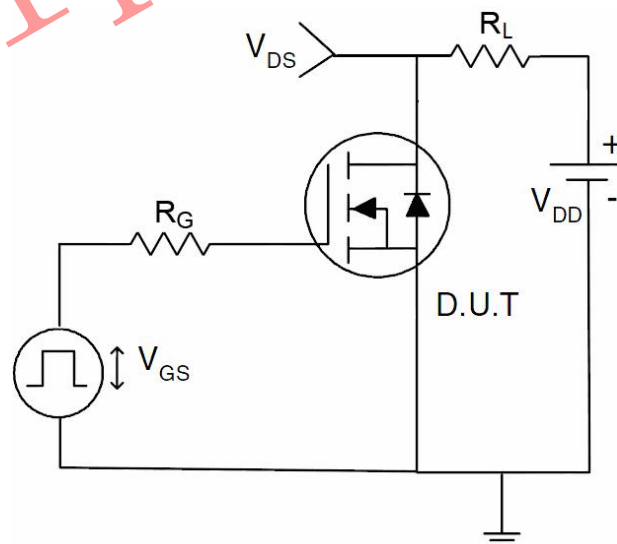



Typical Electrical and Thermal Characteristics (Curves)

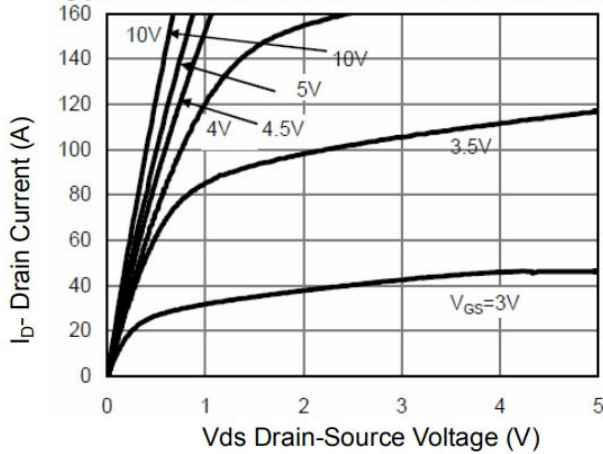

Figure 1 Output Characteristics

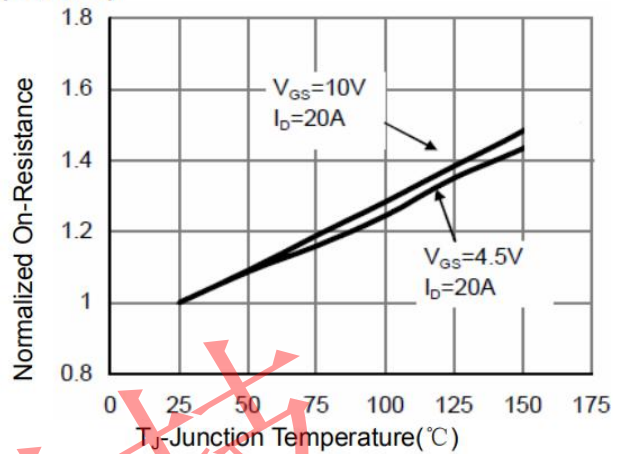

Figure 4 Rds(on)-Junction Temperature

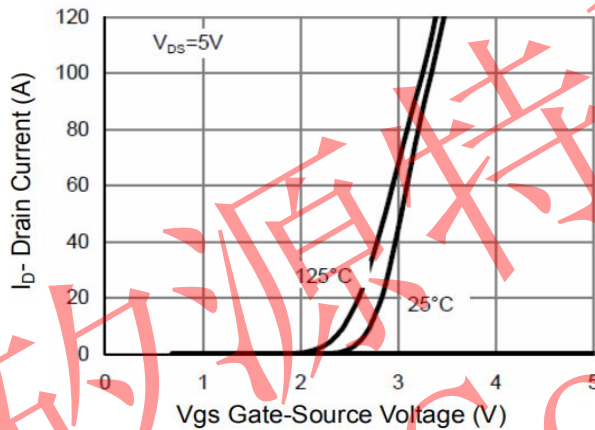

Figure 2 Transfer Characteristics

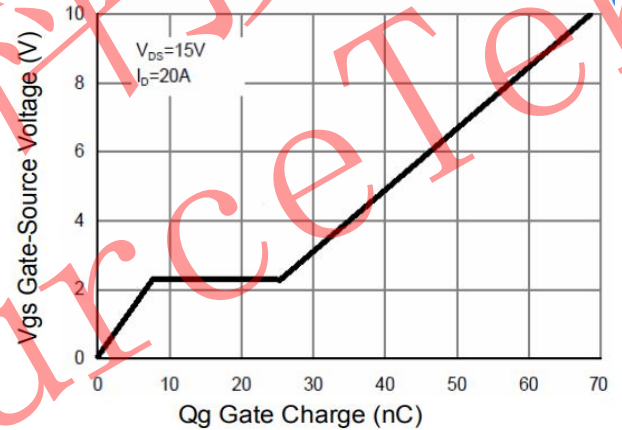

Figure 5 Gate Charge

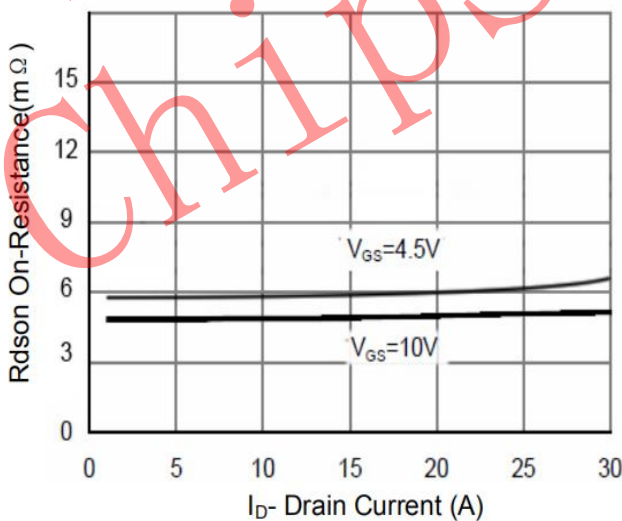

Figure 3 Rds(on)- Drain Current

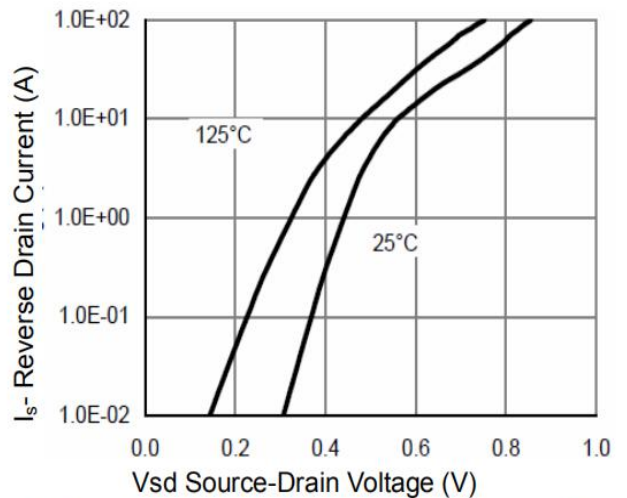

Figure 6 Source- Drain Diode Forward

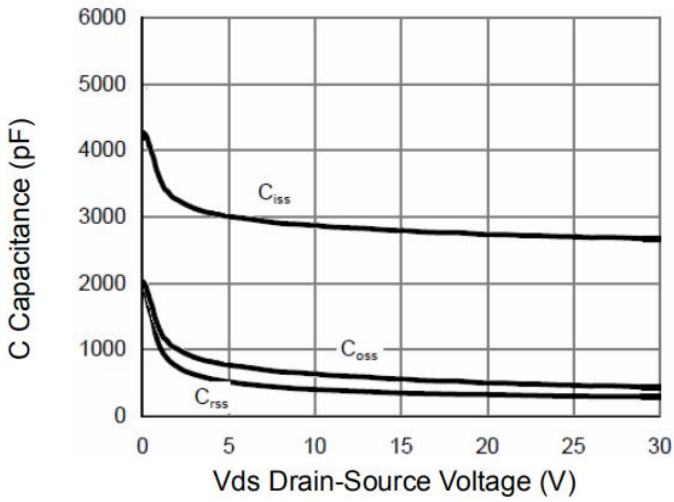

Figure 7 Capacitance vs Vds

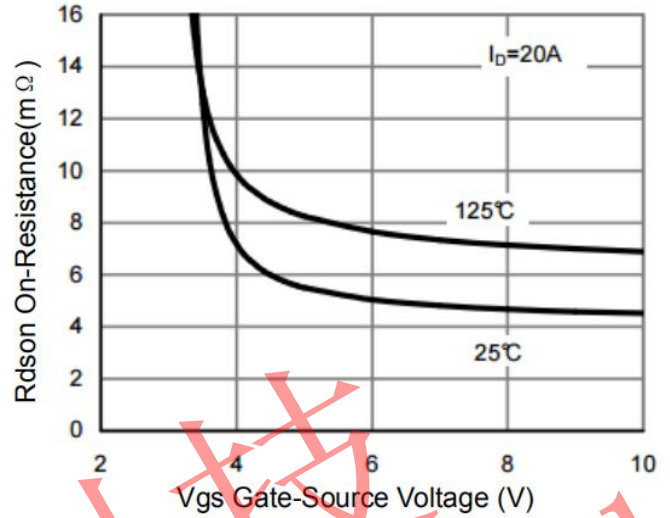

Figure 9 Rdson vs Gate-Source Voltage

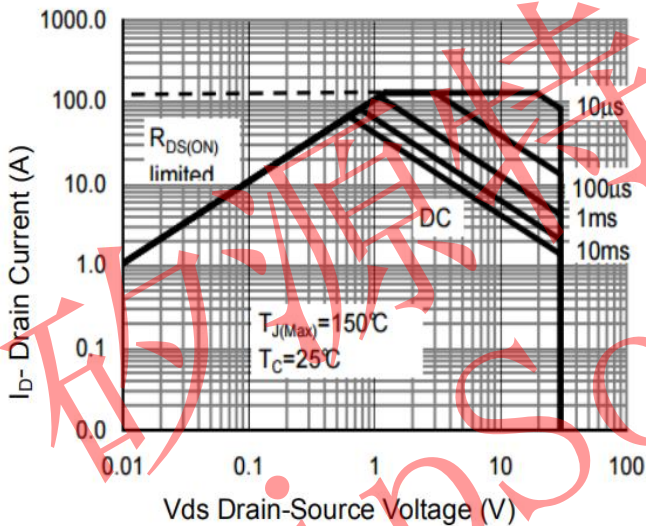

Figure 8 Safe Operation Area

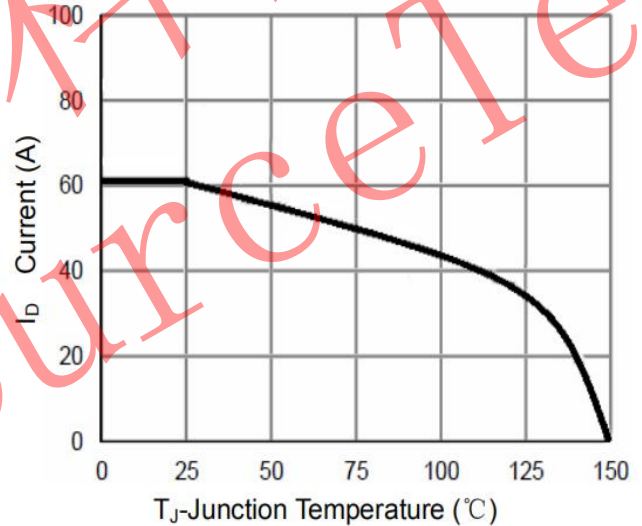

Figure 10 Current- Junction Temperature

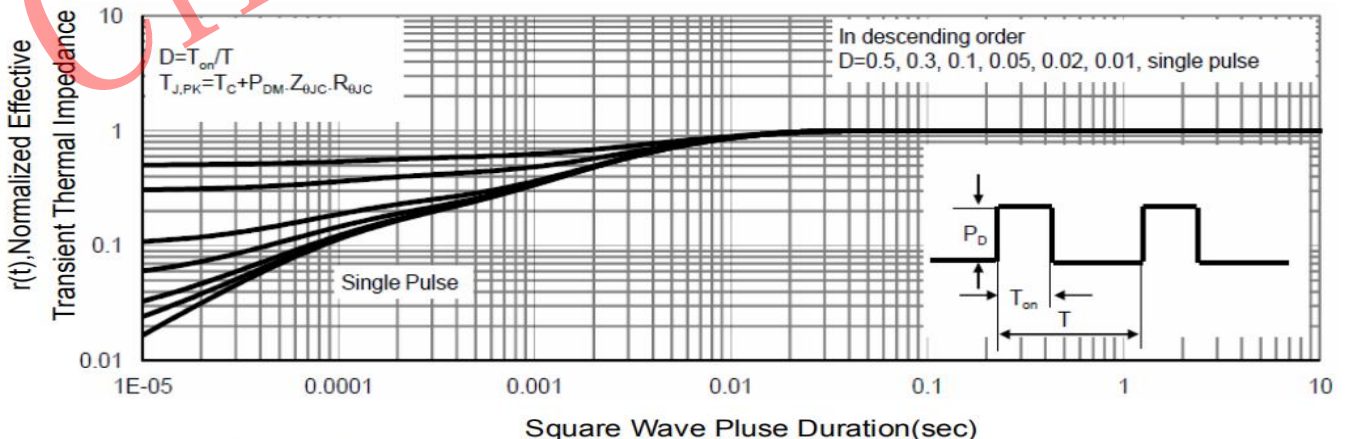
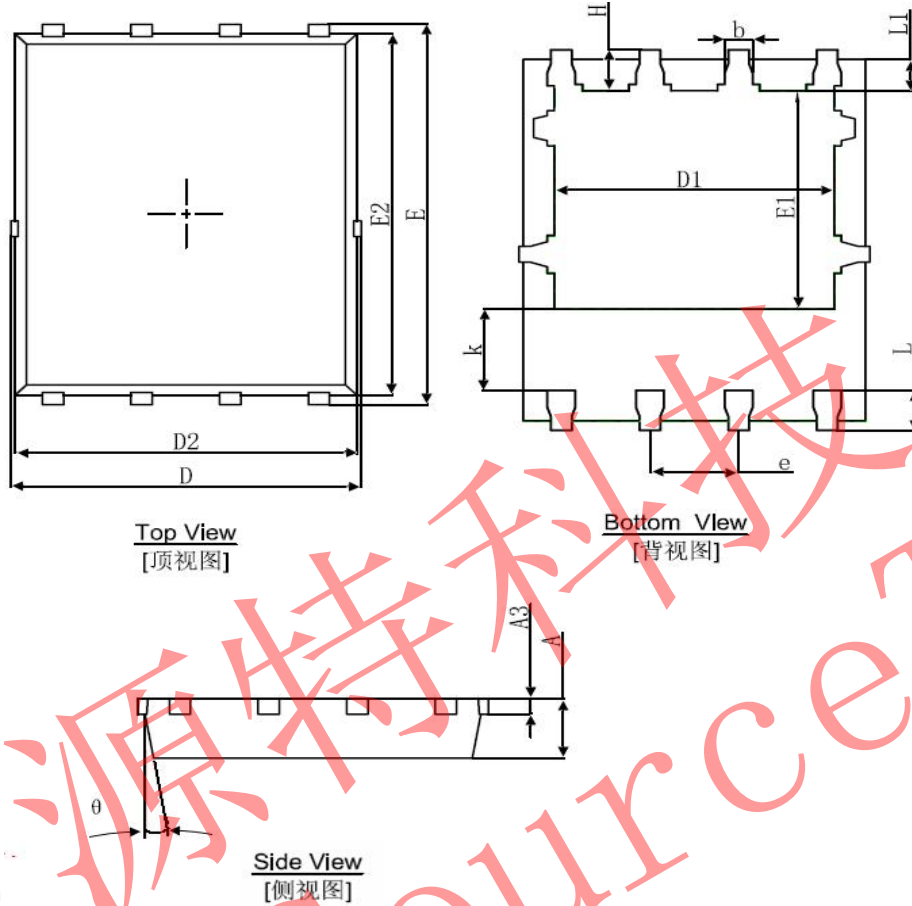

Figure 11 Normalized Maximum Transient Thermal Impedance



DFN5X6-8L Package Information



| Symbol   | Dimensions In Millimeters |       | Dimensions In Inches |       |
|----------|---------------------------|-------|----------------------|-------|
|          | Min.                      | Max.  | Min.                 | Max.  |
| A        | 0.900                     | 1.000 | 0.035                | 0.039 |
| A3       | 0.254REF.                 |       | 0.010REF.            |       |
| D        | 4.944                     | 5.096 | 0.195                | 0.201 |
| E        | 5.974                     | 6.126 | 0.235                | 0.241 |
| D1       | 3.910                     | 4.110 | 0.154                | 0.162 |
| E1       | 3.375                     | 3.575 | 0.133                | 0.141 |
| D2       | 4.824                     | 4.976 | 0.190                | 0.196 |
| E2       | 5.674                     | 5.826 | 0.223                | 0.229 |
| k        | 1.190                     | 1.390 | 0.047                | 0.055 |
| b        | 0.350                     | 0.450 | 0.014                | 0.018 |
| e        | 1.270TYP.                 |       | 0.050TYP.            |       |
| L        | 0.559                     | 0.711 | 0.022                | 0.028 |
| L1       | 0.424                     | 0.576 | 0.017                | 0.023 |
| H        | 0.574                     | 0.726 | 0.023                | 0.029 |
| $\theta$ | 8°                        | 12°   | 8°                   | 12°   |