

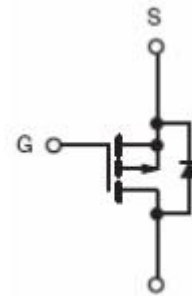

P-Channel Enhancement Mode Power MOSFET

Description

The MXN3345 uses advanced trench technology to provide excellent RDS(ON), low gate charge and operation with gate voltages as low as 4.5V. This device is suitable for use as a load switch or in PWM and a wide variety of applications.



Schematic diagram

General Features

- ◆ $V_{DS} = -30V$, $I_D = -30A$
- ◆ $R_{DS(ON)}$ (Typ.) = $12\ m\ \Omega$ @ $V_{GS} = -10V$
- ◆ $R_{DS(ON)}$ (Typ.) = $22\ m\ \Omega$ @ $V_{GS} = -4.5V$

High Power and current handling capability
Lead free product is acquired
Surface mount package

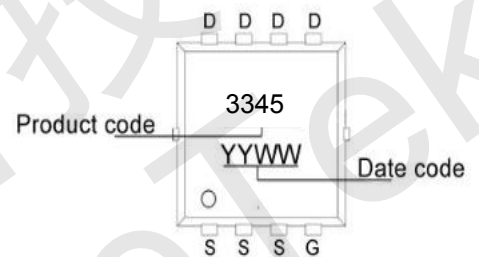

Marking and pin Assignment

Application

PWM applications
Load switch
Power management

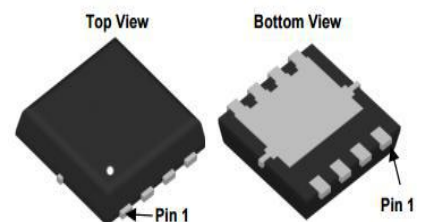

PDFN3.3x3.3-8L

Absolute Maximum Ratings (TA=25°C unless otherwise noted)

Parameter	Symbol	Limit	Unit
Drain-Source Voltage	V_{DS}	-30	V
Gate-Source Voltage	V_{GS}	± 20	V
Drain Current-Continuous, $T_C = 25^\circ C$	I_D	-30	A
Drain Current-Pulsed (Note 1)	I_{DM}	-80	A
Drain Current-Continuous, $T_A = 25^\circ C$	I_{DSM}	-11	A
Maximum Power Dissipation, $T_A = 25^\circ C$	P_{DSM}	3.1	W
Maximum Power Dissipation, $T_C = 25^\circ C$	P_D	29	W
Operating Junction and Storage Temperature Range	T_J, T_{STG}	-55 To 150	$^\circ C$



Electrical Characteristics (TA=25°C unless otherwise noted)

Parameter	Symbol	Condition	Min	Typ	Max	Unit
Drain-Source Breakdown Voltage	BV _{DSS}	V _{GS} =0V, I _D =-250μA	-30	-	-	V
Zero Gate Voltage Drain Current	I _{DSS}	V _{DS} =-30V, V _{GS} =0V	-	-	-1	μA
Gate-Body Leakage Current	I _{GSS}	V _{GS} =±20V, V _{DS} =0V	-	-	±100	nA
On Characteristics (Note 3)						
Gate Threshold Voltage	V _{GS(th)}	V _{DS} =V _{GS} , I _D =-250μA	-1	-1.4	-2.5	V
Drain-Source On-State Resistance	R _{DS(on)}	V _{GS} =-10V, I _D =-8A	-	12	15	mΩ
		V _{GS} =-4.5V, I _D =-7A	-	22	26	mΩ
Forward Transconductance	g _{FS}	V _{DS} =-10V, I _D =-10A	20	-	-	S
Dynamic Characteristics (Note4)						
Input Capacitance	C _{iss}	V _{DS} =-15V, V _{GS} =0V, F=1.0MHz	-	1600	-	PF
Output Capacitance	C _{oss}		-	350	-	PF
Reverse Transfer Capacitance	C _{rss}		-	300	-	PF
Switching Characteristics (Note 4)						
Turn-on Delay Time	t _{d(on)}	V _{DD} =-15V, I _D =-10A, V _{GS} =-10V, R _{GEN} =1Ω	-	10	-	nS
Turn-on Rise Time	t _r		-	15	-	nS
Turn-Off Delay Time	t _{d(off)}		-	110	-	nS
Turn-Off Fall Time	t _f		-	70	-	nS
Total Gate Charge	Q _g	V _{DS} =-15V, I _D =-10A, V _{GS} =-10V	-	30	-	nC
Gate-Source Charge	Q _{gs}		-	5.5	-	nC
Gate-Drain Charge	Q _{gd}		-	8	-	nC
Drain-Source Diode Characteristics						
Diode Forward Voltage (Note 3)	V _{SD}	V _{GS} =0V, I _S =-2A	-0.4	-	-1.0	V

Thermal Characteristic

Thermal Resistance, Junction-to-Ambient (Note 2)	R _{θJA}	40	°C/W
Thermal Resistance, Junction-to-Case, Steady State	R _{θJC}	4.2	°C/W

Notes:

1. Repetitive Rating: Pulse width limited by maximum junction temperature.
2. Surface Mounted on FR4 Board, t ≤ 10 sec.
3. Pulse Test: Pulse Width ≤ 300μs, Duty Cycle ≤ 2%.
4. Guaranteed by design, not subject to production



TYPICAL ELECTRICAL AND THERMAL CHARACTERISTICS

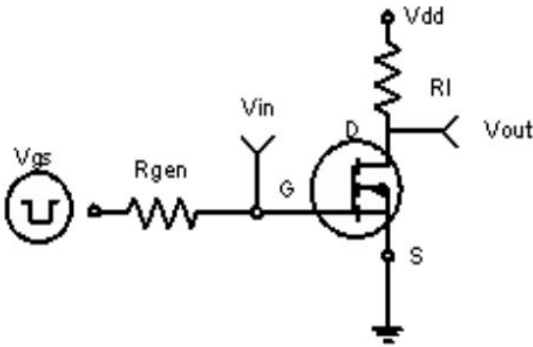

Figure 1: Switching Test Circuit

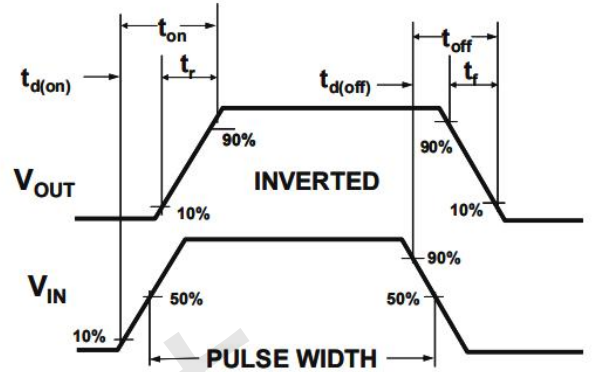

Figure 2: Switching Waveforms

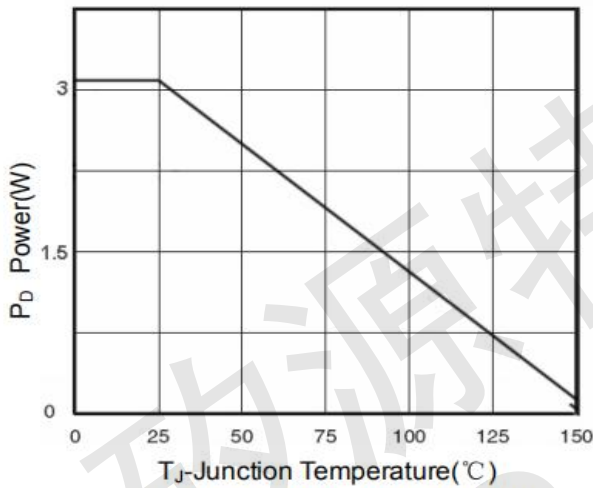

Figure 3 Power Dissipation

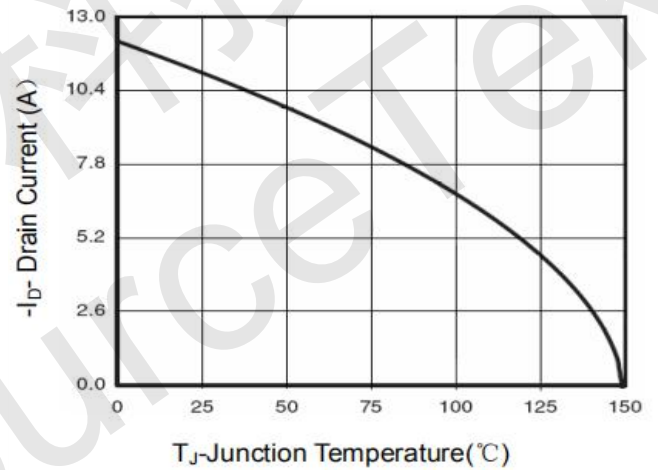

Figure 4 Drain Current

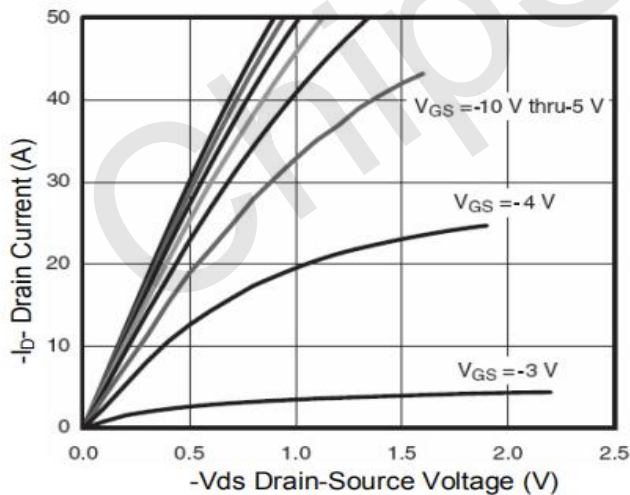

Figure 5 Output Characteristics

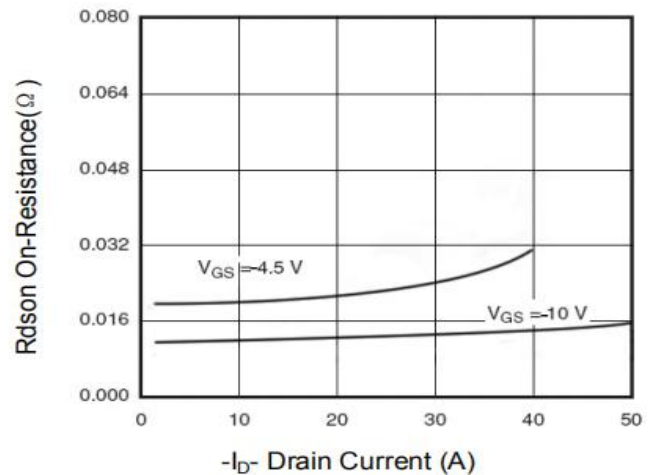

Figure 6 Drain-Source On-Resistance

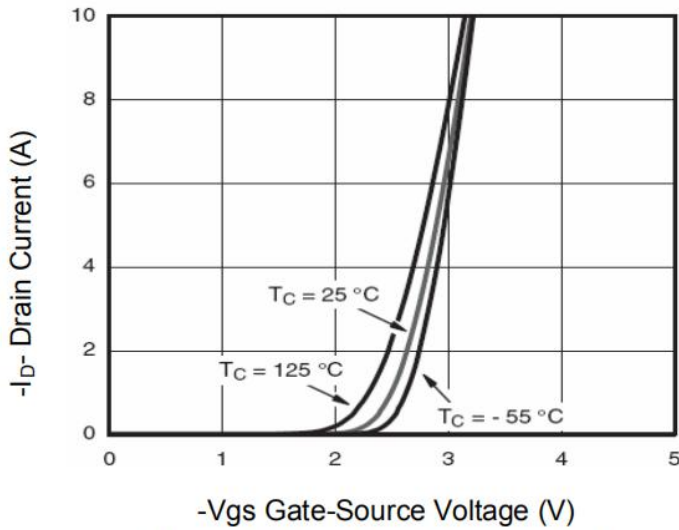

Figure 7 Transfer Characteristics

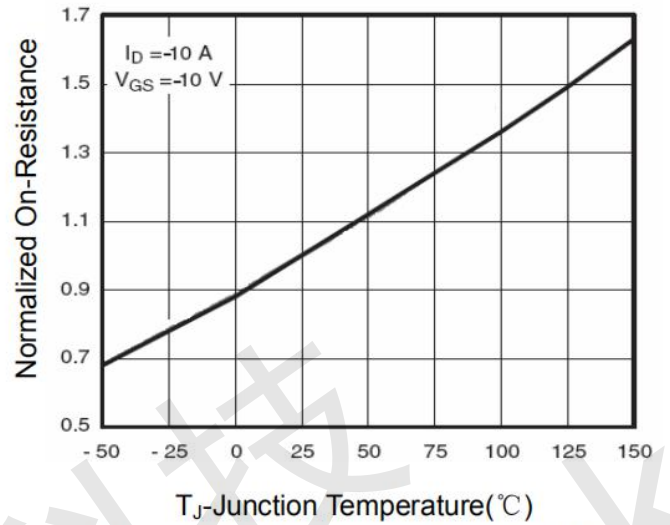

Figure 8 Drain-Source On-Resistance

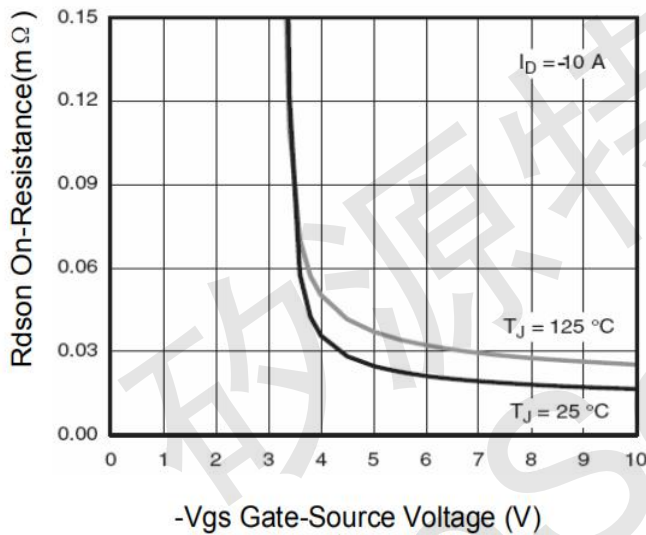

Figure 9 Rdson vs Vgs

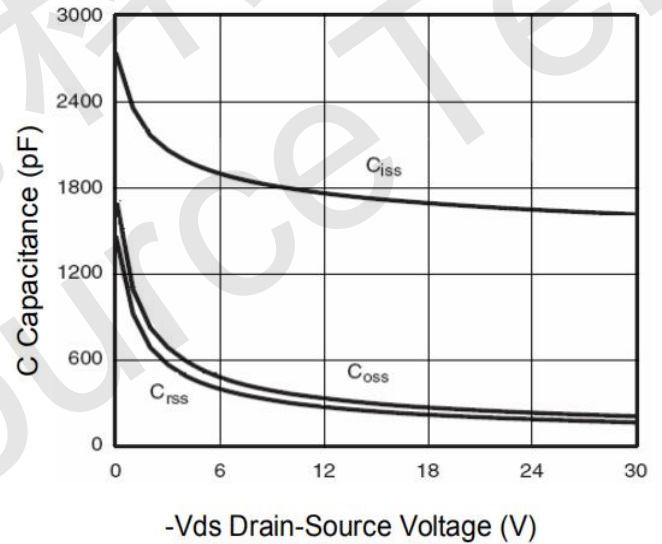

Figure 10 Capacitance vs Vds

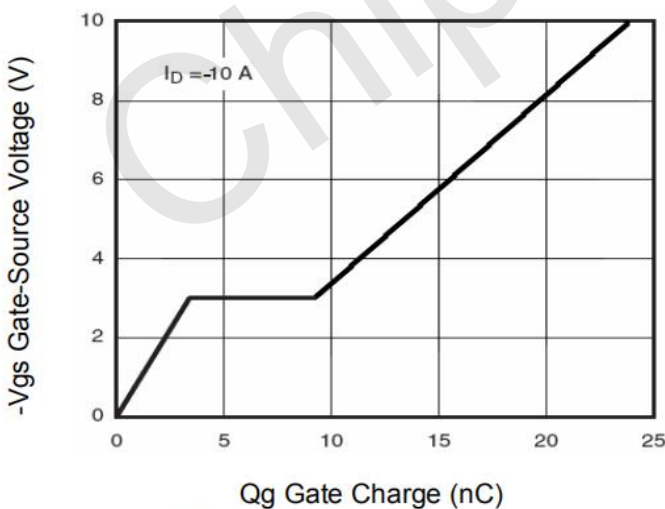

Figure 11 Gate Charge

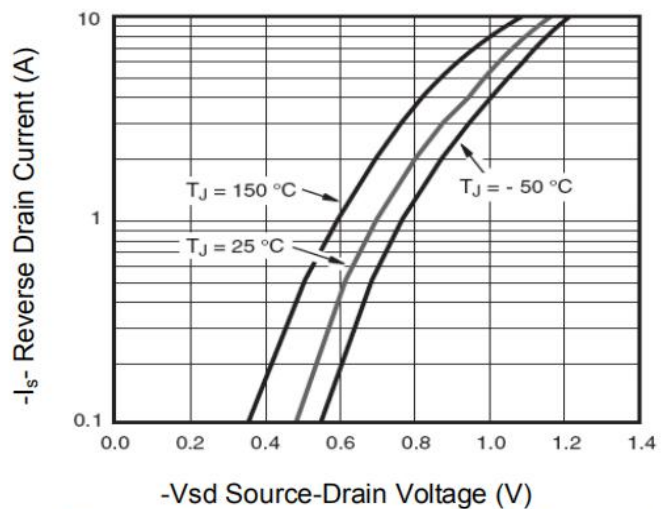

Figure 12 Source- Drain Diode Forward

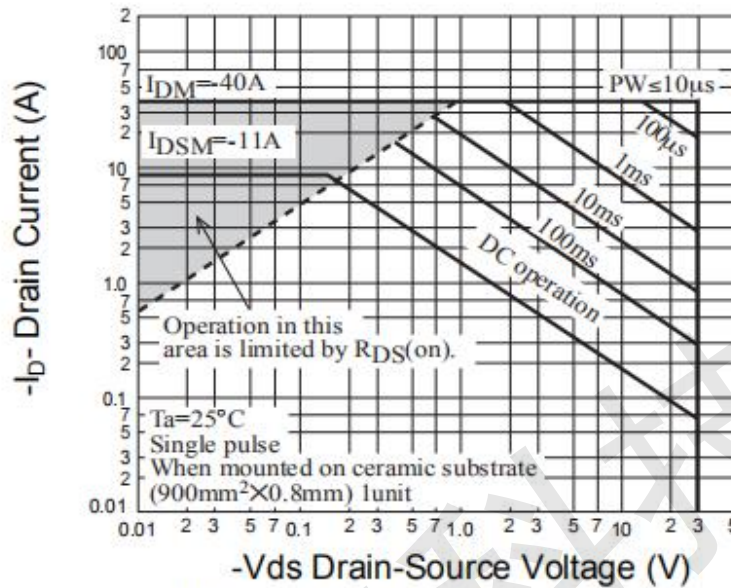

Figure 13 Safe Operation Area

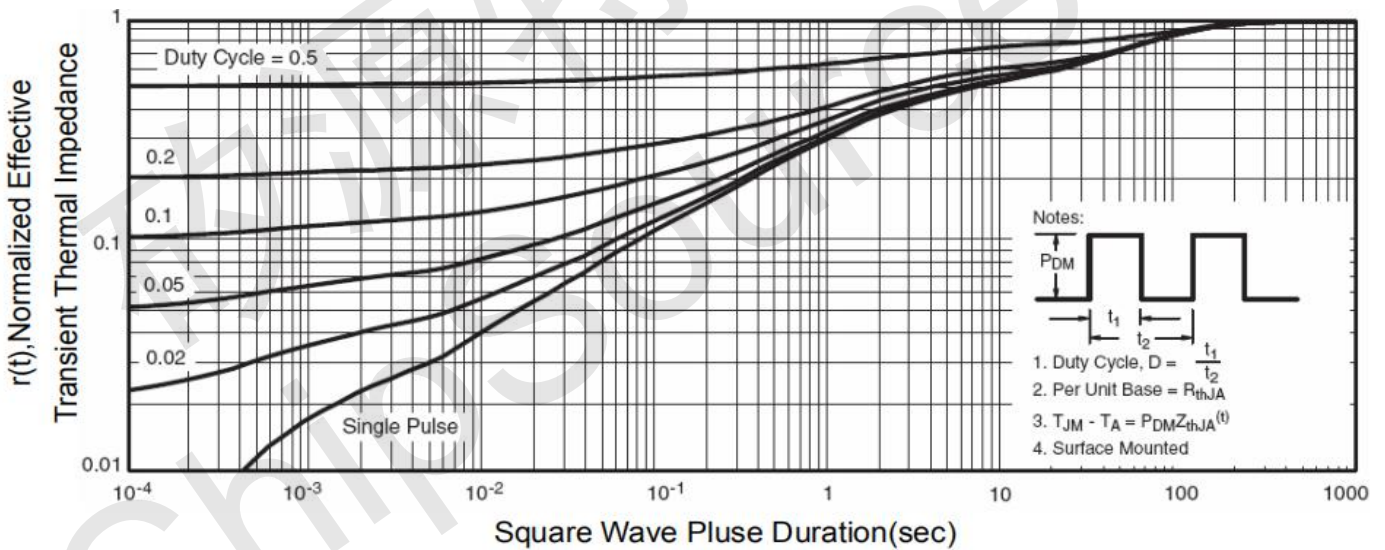
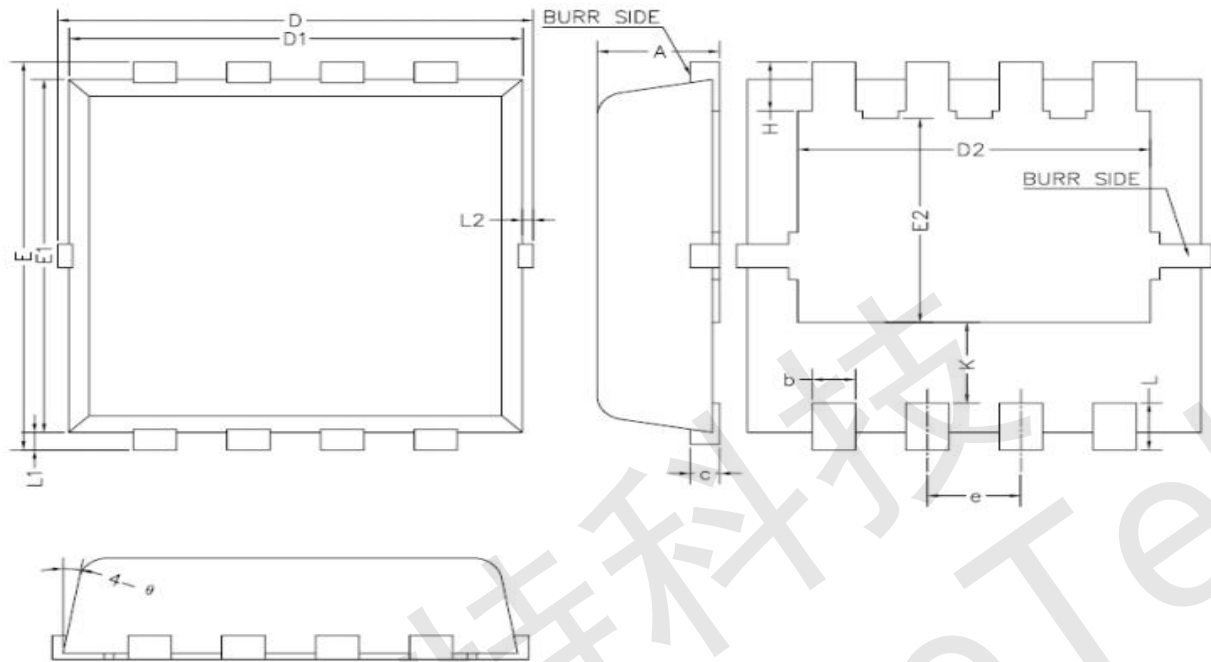

Figure 14 Normalized Maximum Transient Thermal Impedance



PDFN3.3x3.3-8L PACKAGE



COMMON DIMENSIONS
(UNITS OF MEASURE=MILLIMETER)

SYMBOL	MIN	NOM	MAX
A	0.70	0.80	0.90
b	0.25	0.30	0.35
c	0.14	0.15	0.20
D	3.10	3.30	3.50
D1	3.05	3.15	3.25
D2	2.35	2.45	2.55
e	0.55	0.65	0.75
E	3.10	3.30	3.50
E1	2.90	3.00	3.10
E2	1.64	1.74	1.84
H	0.32	0.42	0.52
K	0.59	0.69	0.79
L	0.25	0.40	0.55
L1	0.10	0.15	0.20
L2	—	—	0.15
θ	8°	10°	12°