

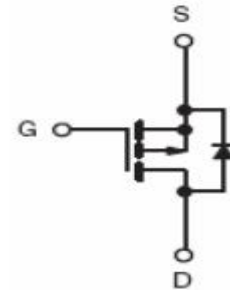

### P-Channel Enhancement Mode Power MOSFET

#### Description

The MXN3347 uses advanced trench technology to provide excellent RDS(ON), low gate charge and operation with gate voltages as low as 4.5V. This device is suitable for use as a load switch or in PWM and a wide variety of applications.



Schematic diagram

#### General Features

- ◆  $V_{DS} = -30V$ ,  $I_D = -35A$
- ◆  $R_{DS(ON)}$  (Typ.) =  $9\ m\ \Omega$  @  $V_{GS} = -10V$
- ◆  $R_{DS(ON)}$  (Typ.) =  $13.5\ m\ \Omega$  @  $V_{GS} = -4.5V$

High Power and current handing capability  
Lead free product is acquired  
Surface mount package

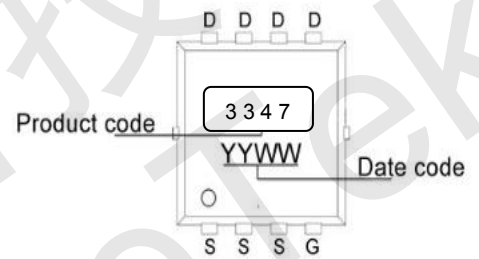

Marking and pin Assignment

#### Application

PWM applications  
Load switch  
Power management

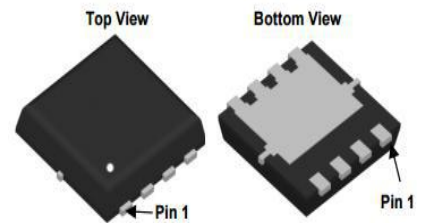

PDFN3.3x3.3-8L

#### Absolute Maximum Ratings (TA=25°C unless otherwise noted)

Parameter	Symbol	Limit	Unit
Drain-Source Voltage	$V_{DS}$	-30	V
Gate-Source Voltage	$V_{GS}$	$\pm 20$	V
Drain Current-Continuous, $T_C = 25^\circ C$	$I_D$	-35	A
Drain Current-Pulsed (Note 1)	$I_{DM}$	-90	A
Drain Current-Continuous, $T_A = 25^\circ C$	$I_{DSM}$	-13	A
Maximum Power Dissipation, $T_A = 25^\circ C$	$P_{DSM}$	3.1	W
Maximum Power Dissipation, $T_C = 25^\circ C$	$P_D$	29	W
Operating Junction and Storage Temperature Range	$T_J, T_{STG}$	-55 To 150	$^\circ C$



#### Electrical Characteristics (TA=25°C unless otherwise noted)

Parameter	Symbol	Condition	Min	Typ	Max	Unit
Drain-Source Breakdown Voltage	BV <sub>DSS</sub>	V <sub>GS</sub> =0V, I <sub>D</sub> =-250μA	-30	-	-	V
Zero Gate Voltage Drain Current	I <sub>DSS</sub>	V <sub>DS</sub> =-30V, V <sub>GS</sub> =0V	-	-	-1	μA
Gate-Body Leakage Current	I <sub>GSS</sub>	V <sub>GS</sub> =±20V, V <sub>DS</sub> =0V	-	-	±100	nA
<b>On Characteristics</b> (Note 3)						
Gate Threshold Voltage	V <sub>GS(th)</sub>	V <sub>DS</sub> =V <sub>GS</sub> , I <sub>D</sub> =-250μA	-1	-1.4	-2.5	V
Drain-Source On-State Resistance	R <sub>DS(on)</sub>	V <sub>GS</sub> =-10V, I <sub>D</sub> =-8A	-	9	12	mΩ
		V <sub>GS</sub> =-4.5V, I <sub>D</sub> =-7A	-	13.5	16	mΩ
Forward Transconductance	g <sub>FS</sub>	V <sub>DS</sub> =-10V, I <sub>D</sub> =-10A	20	-	-	S
<b>Dynamic Characteristics</b> (Note4)						
Input Capacitance	C <sub>iss</sub>	V <sub>DS</sub> =-15V, V <sub>GS</sub> =0V, F=1.0MHz	-	1200	-	PF
Output Capacitance	C <sub>oss</sub>		-	200	-	PF
Reverse Transfer Capacitance	C <sub>rss</sub>		-	150	-	PF
<b>Switching Characteristics</b> (Note 4)						
Turn-on Delay Time	t <sub>d(on)</sub>	V <sub>DD</sub> =-15V, I <sub>D</sub> =-10A, V <sub>GS</sub> =-10V, R <sub>GEN</sub> =1Ω	-	11	-	nS
Turn-on Rise Time	t <sub>r</sub>		-	6	-	nS
Turn-Off Delay Time	t <sub>d(off)</sub>		-	28	-	nS
Turn-Off Fall Time	t <sub>f</sub>		-	10	-	nS
Total Gate Charge	Q <sub>g</sub>	V <sub>DS</sub> =-15V, I <sub>D</sub> =-10A, V <sub>GS</sub> =-10V	-	25	-	nC
Gate-Source Charge	Q <sub>gs</sub>		-	3.9	-	nC
Gate-Drain Charge	Q <sub>gd</sub>		-	4.8	-	nC
<b>Drain-Source Diode Characteristics</b>						
Diode Forward Voltage (Note 3)	V <sub>SD</sub>	V <sub>GS</sub> =0V, I <sub>S</sub> =-2A	-0.4	-	-1.0	V

#### Thermal Characteristic

Thermal Resistance, Junction-to-Ambient (Note 2)	R <sub>θJA</sub>	40	°C/W
Thermal Resistance, Junction-to-Case, Steady State	R <sub>θJC</sub>	4.2	°C/W

#### Notes:

1. Repetitive Rating: Pulse width limited by maximum junction temperature.
2. Surface Mounted on FR4 Board, t ≤ 10 sec.
3. Pulse Test: Pulse Width ≤ 300μs, Duty Cycle ≤ 2%.
4. Guaranteed by design, not subject to production



### TYPICAL ELECTRICAL AND THERMAL CHARACTERISTICS

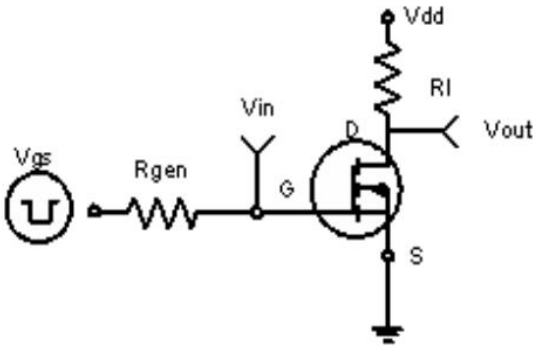

Figure 1: Switching Test Circuit

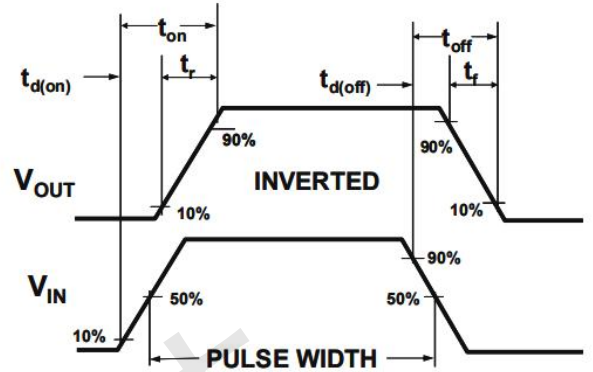

Figure 2: Switching Waveforms

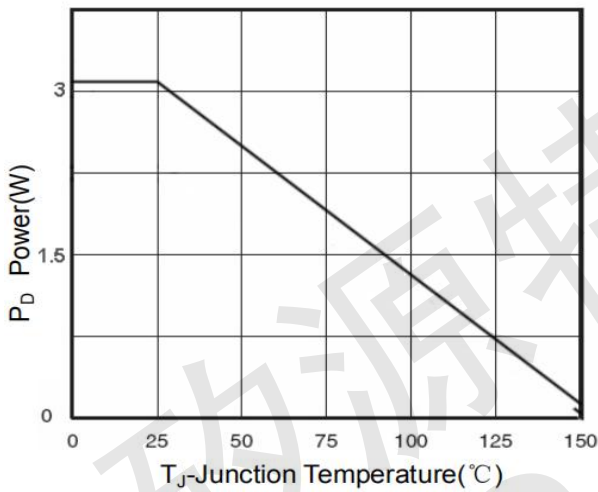

Figure 3 Power Dissipation

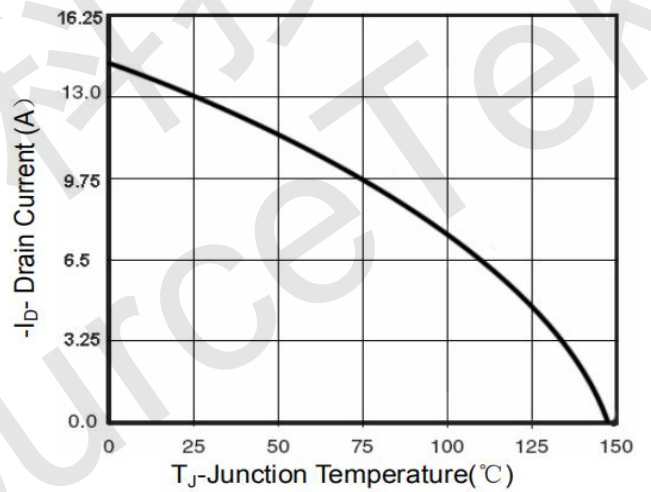

Figure 4 Drain Current

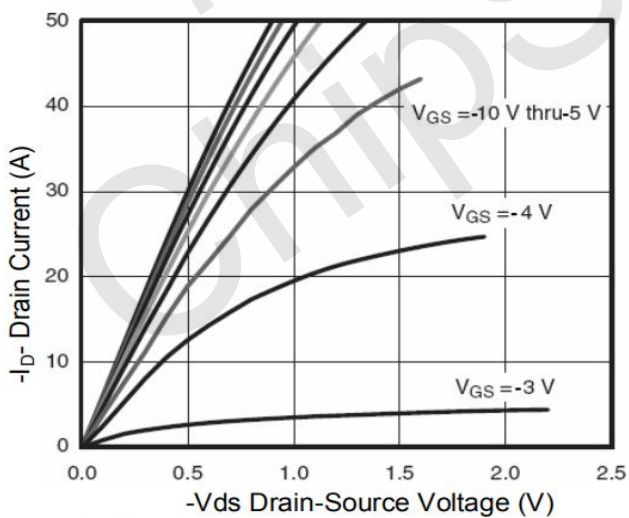

Figure 5 Output Characteristics

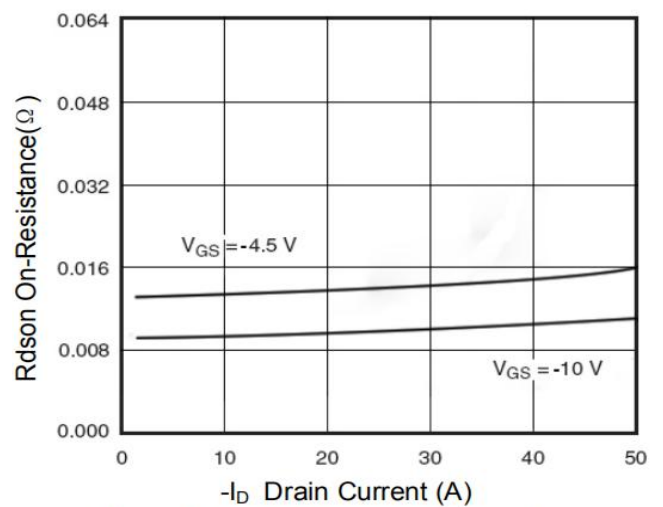

Figure 6 Drain-Source On-Resistance

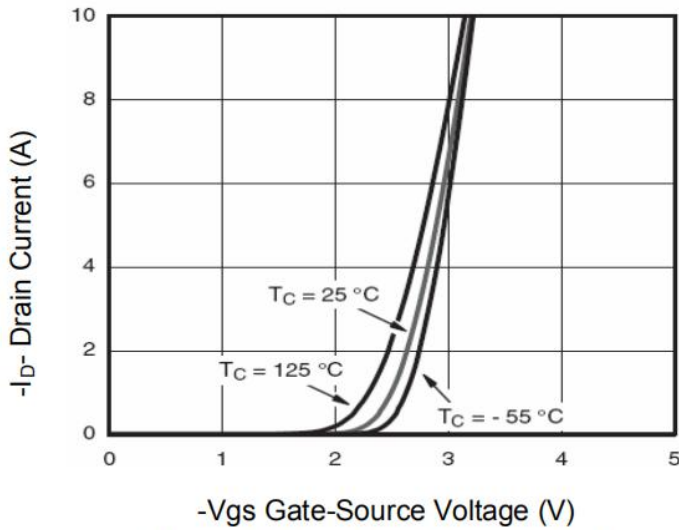

Figure 7 Transfer Characteristics

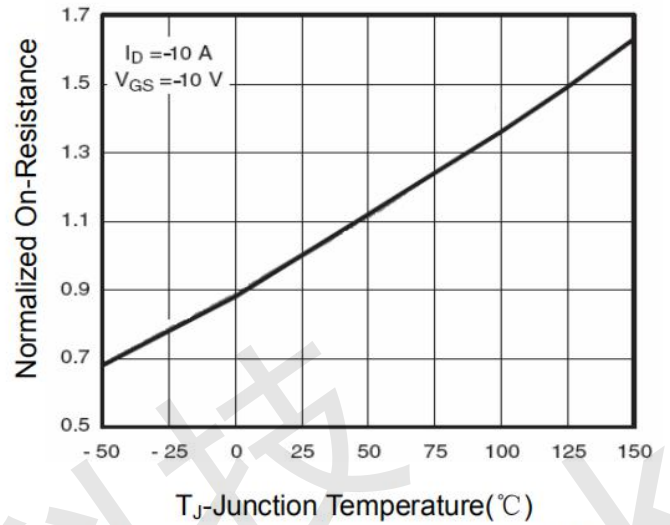

Figure 8 Drain-Source On-Resistance

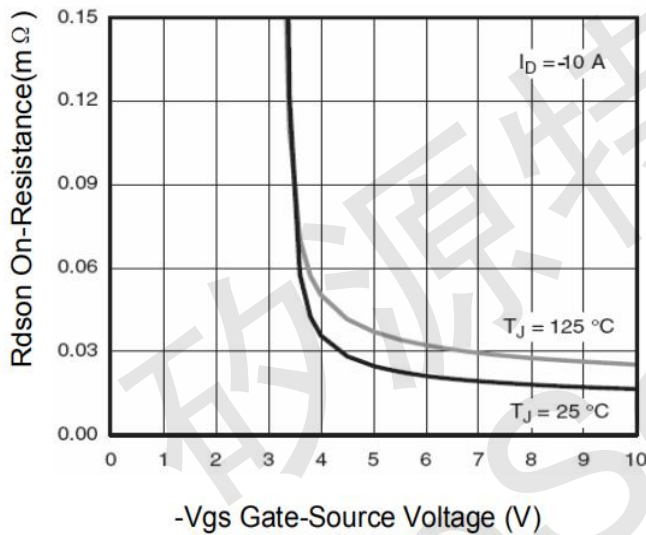

Figure 9 Rdson vs Vgs

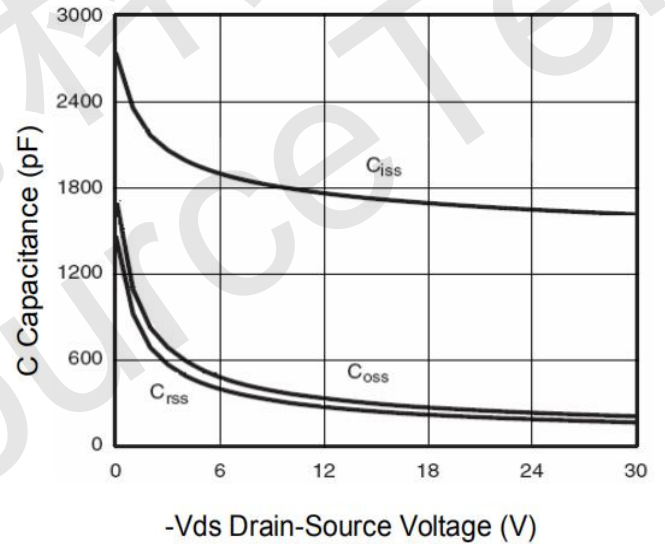

Figure 10 Capacitance vs Vds

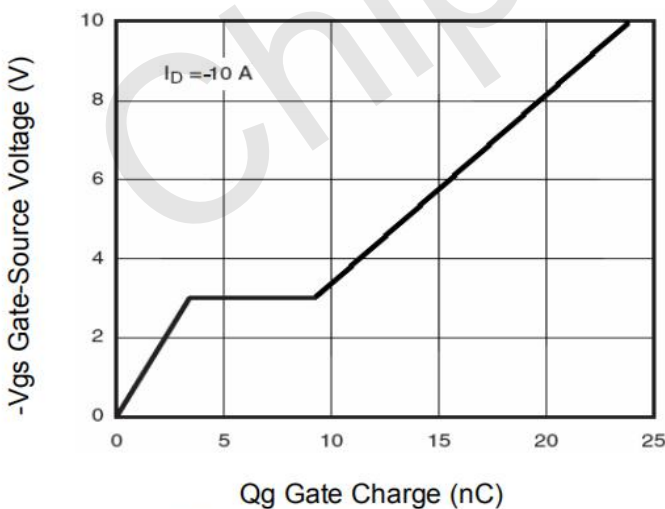

Figure 11 Gate Charge

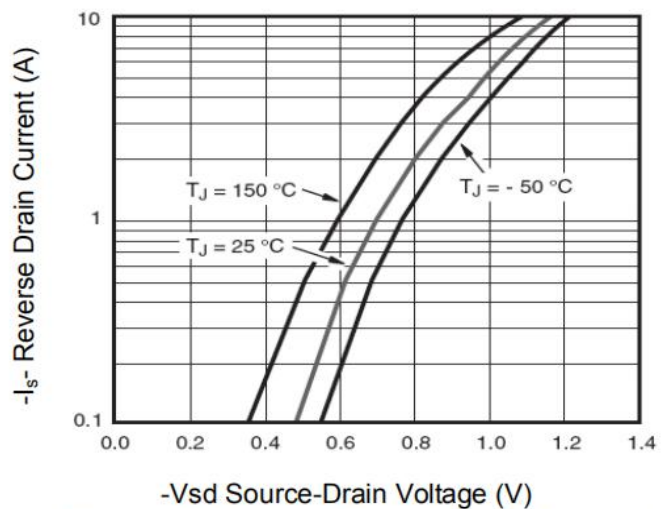

Figure 12 Source- Drain Diode Forward

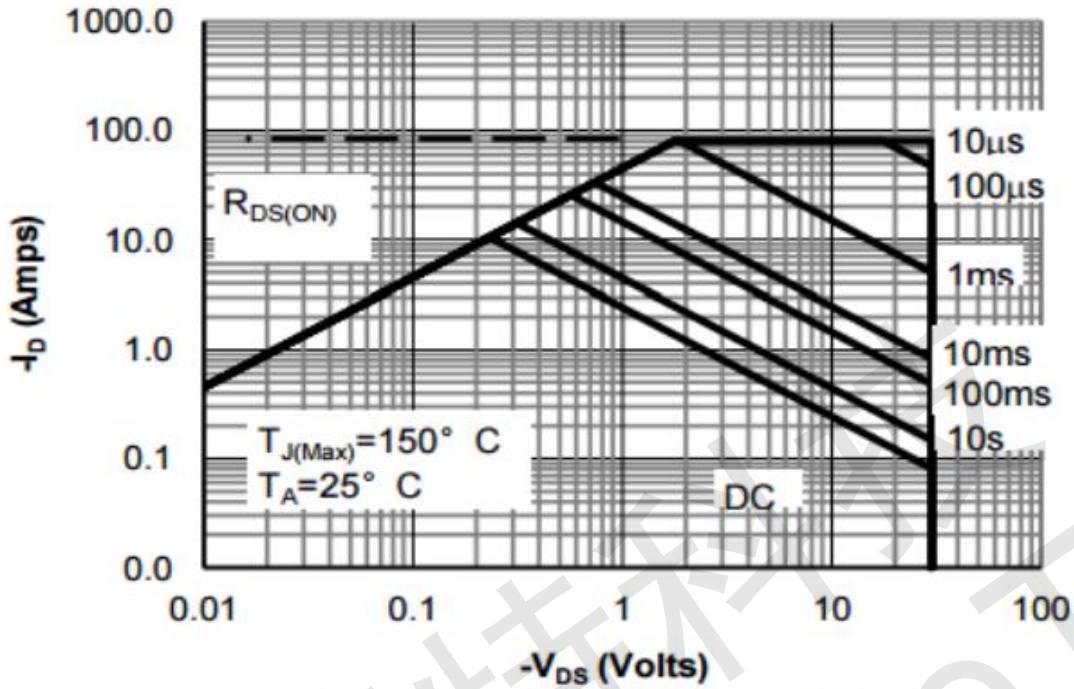

Figure 13 Safe Operation Area

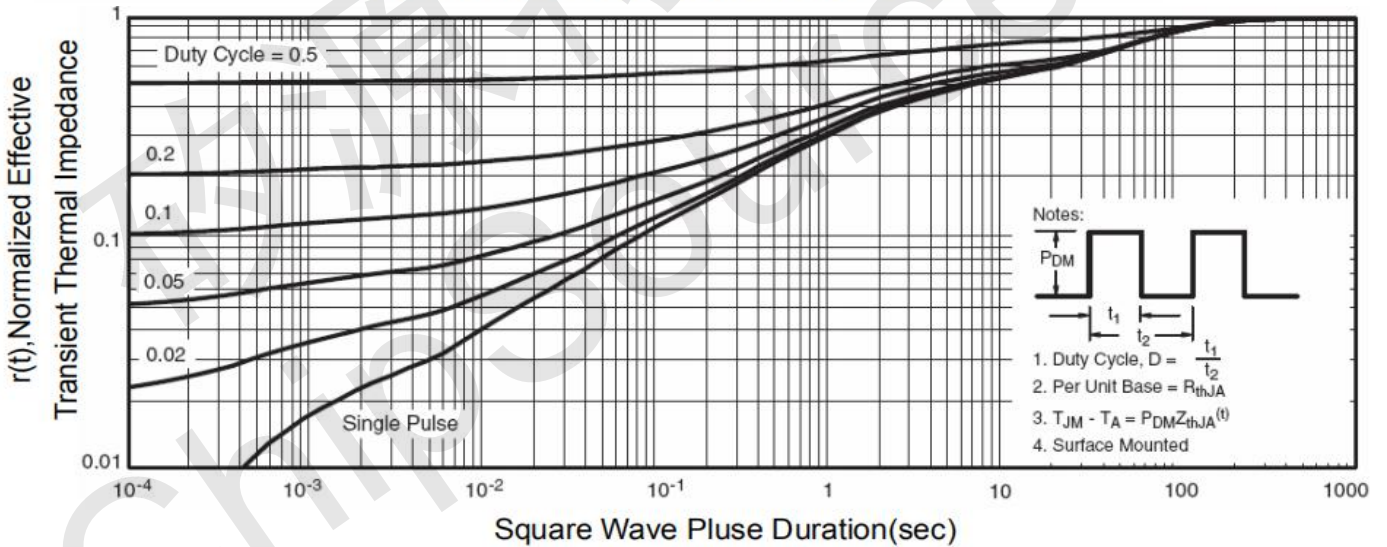
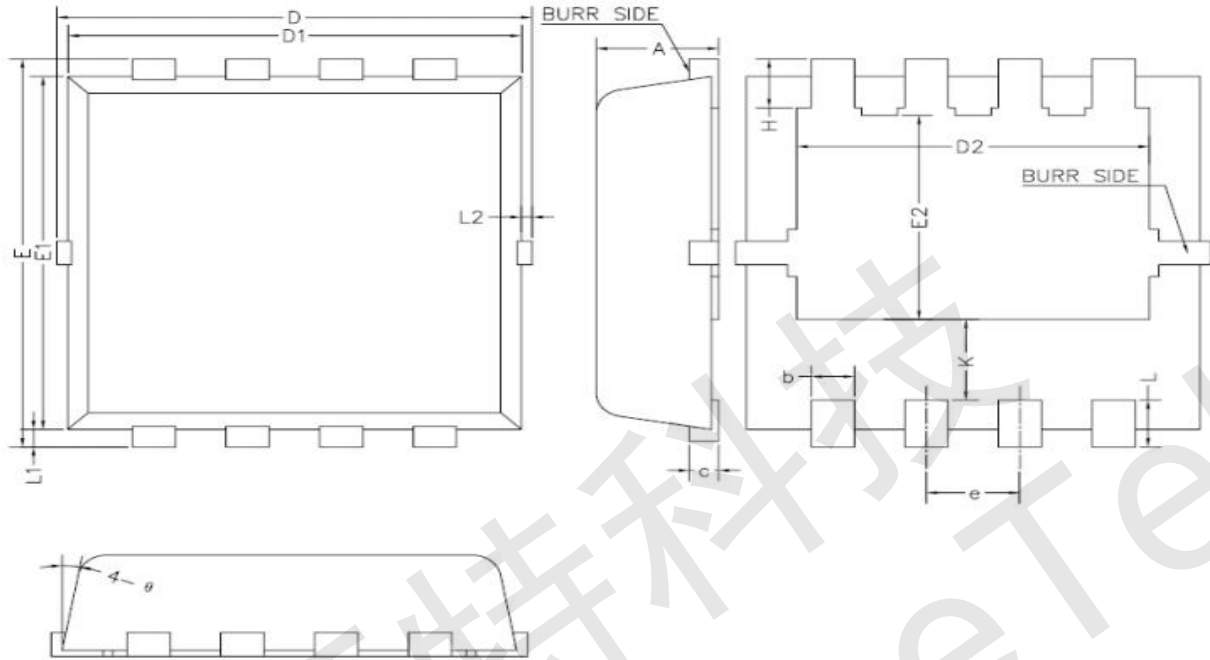

Figure 14 Normalized Maximum Transient Thermal Impedance



PDFN3.3x3.3-8L PACKAGE



COMMON DIMENSIONS  
(UNITS OF MEASURE=MILLIMETER)

SYMBOL	MIN	NOM	MAX
A	0.70	0.80	0.90
b	0.25	0.30	0.35
c	0.14	0.15	0.20
D	3.10	3.30	3.50
D1	3.05	3.15	3.25
D2	2.35	2.45	2.55
e	0.55	0.65	0.75
E	3.10	3.30	3.50
E1	2.90	3.00	3.10
E2	1.64	1.74	1.84
H	0.32	0.42	0.52
K	0.59	0.69	0.79
L	0.25	0.40	0.55
L1	0.10	0.15	0.20
L2	—	—	0.15
θ	8°	10°	12°