



N-Channel Enhancement Mode Power MOSFET

Description

The PE58120PA uses deep trench technology to provide excellent $R_{DS(ON)}$ and low gate charge. It can be used in a wide variety of applications.

General Features

- $V_{DS} = 85V$, $I_D = 120A$

$$R_{DS(ON)} < 5.6m\Omega @ V_{GS}=10V$$

- High Power and current handling capability
- Lead free product is acquired
- Surface Mount Package

Application

- PWM applications
- Load switch
- Power management

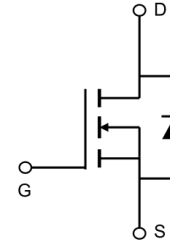

Schematic diagram

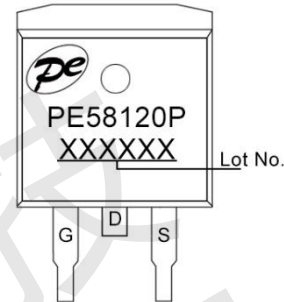

Marking and pin assignment

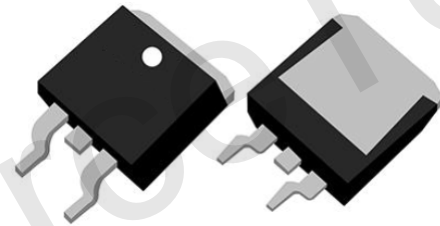

TO-263

Absolute Maximum Ratings (TC=25°C unless otherwise noted)

Parameter	Symbol	Rating	Unit
Drain-Source Voltage	V_{DS}	85	V
Gate-Source Voltage	V_{GS}	± 20	V
Drain Current-Continuous	I_D	120	A
Drain Current-Continuous ($T_C=100^\circ C$)	$I_D(T_C=100^\circ C)$	80	A
Pulsed Drain Current (Note 1)	I_{DM}	360	A
Maximum Power Dissipation	P_D	180	W
Avalanche Energy ($L=0.5mH$)	E_{AS}	780	mJ
Operating Junction and Storage Temperature Range	T_J, T_{STG}	-55 To 175	$^\circ C$

Thermal Characteristic

Thermal Resistance, Junction-to-Case (Note 2)	$R_{\theta JC}$	0.83	$^\circ C/W$
---	-----------------	------	--------------



Electrical Characteristics (TC=25°C unless otherwise noted)

Parameter	Symbol	Condition	Min	Typ	Max	Unit
Off Characteristics						
Drain-Source Breakdown Voltage	BV_{DSS}	$V_{GS}=0V, I_D=250\mu A$	85	-	-	V
Zero Gate Voltage Drain Current	I_{DSS}	$V_{DS}=80V, V_{GS}=0V$	-	-	1	μA
Gate-Body Leakage Current	I_{GSS}	$V_{GS}=\pm 20V, V_{DS}=0V$	-	-	± 100	nA
On Characteristics (Note 3)						
Gate Threshold Voltage	$V_{GS(th)}$	$V_{DS}=V_{GS}, I_D=250\mu A$	2.4	3.0	3.8	V
Drain-Source On-State Resistance	$R_{DS(ON)}$	$V_{GS}=10V, I_D=50A$	3.6	4.7	5.6	m Ω
Forward Transconductance	g_{FS}	$V_{DS}=5V, I_D=40A$	-	75	-	S
Dynamic Characteristics (Note 4)						
Input Capacitance	C_{iss}	$V_{DS}=42.5V, V_{GS}=0V,$ $F=1.0MHz$	-	2600	-	pF
Output Capacitance	C_{oss}		-	420	-	pF
Reverse Transfer Capacitance (Note 4)	C_{rss}		-	20	-	pF
Gate Resistance	R_g	$V_{DS}=0V, V_{GS}=0V, F=1.0MHz$	-	1	-	Ω
Switching Characteristics						
Turn-on Delay Time	$t_{d(on)}$	$V_{DD}=40V, I_D=10A, R_L=1\Omega,$ $V_{GS}=10V, R_G=3\Omega$	-	10	-	nS
Turn-on Rise Time	t_r		-	22	-	nS
Turn-Off Delay Time	$t_{d(off)}$		-	25	-	nS
Turn-Off Fall Time	t_f		-	13	-	nS
Total Gate Charge	Q_g	$V_{DS}=40V, I_D=50A, V_{GS}=10V$	-	40	-	nC
Gate-Source Charge	Q_{gs}		-	11	-	nC
Gate-Drain Charge	Q_{gd}		-	10	-	nC
Drain-Source Diode Characteristics						
Diode Forward Voltage (Note 3)	V_{SD}	$V_{GS}=0V, I_S=50A$	-	-	1.2	V
Diode Forward Current (Note 2)	I_S		-	-	120	A

Notes:

1. Repetitive Rating: Pulse width limited by maximum junction temperature.
2. Surface Mounted on FR4 Board, $t \leq 10$ sec.
3. Pulse Test: Pulse Width $\leq 300\mu s$, Duty Cycle $\leq 2\%$.
4. Guaranteed by design, not subject to product.



Typical Electrical and Thermal Characteristics

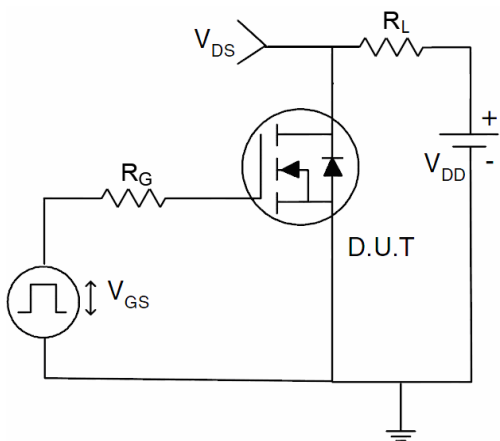

Figure 1 Switching Test Circuit

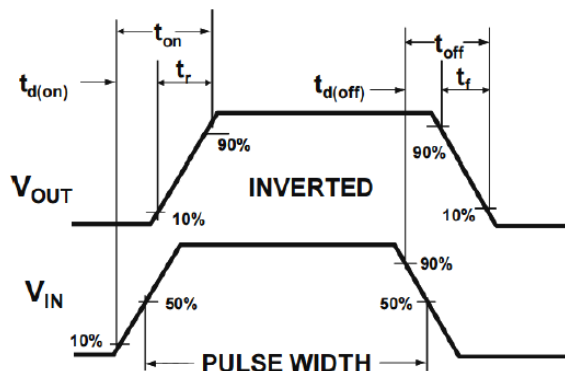
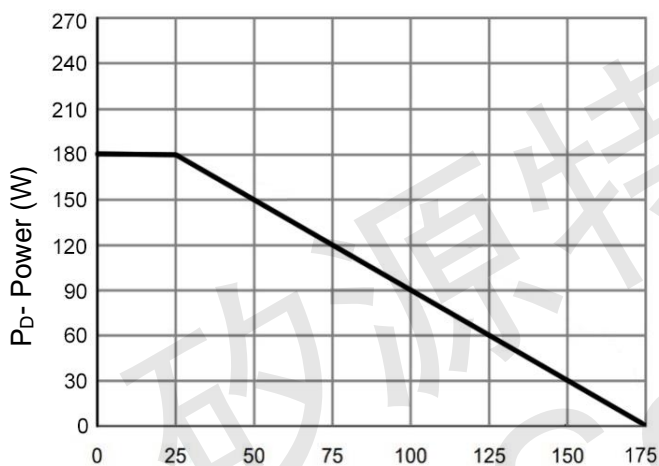
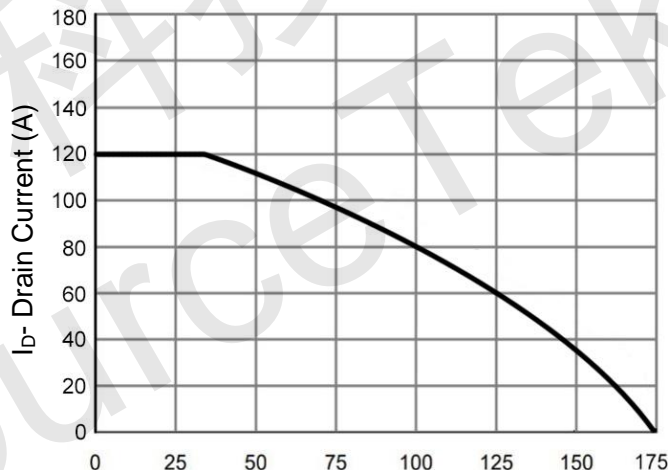

Figure 2 Switching Waveform



T_J-Junction Temperature (°C)

Figure 3 Power De-rating



T_J-Junction Temperature (°C)

Figure 4 Drain Current

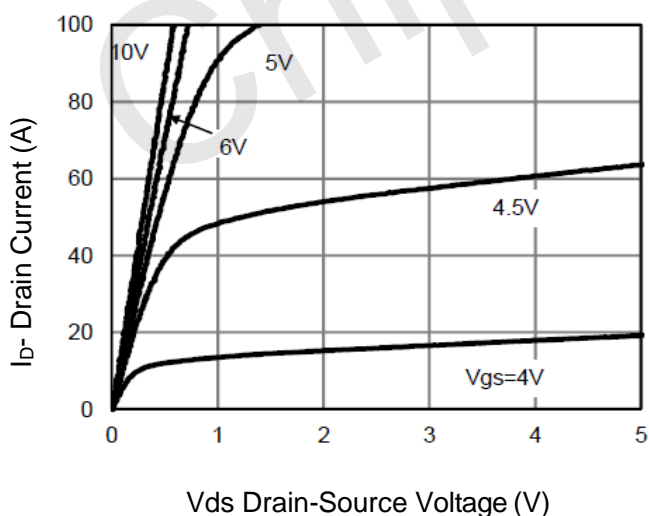

V_{DS} Drain-Source Voltage (V)

Figure 5 Output Characteristics

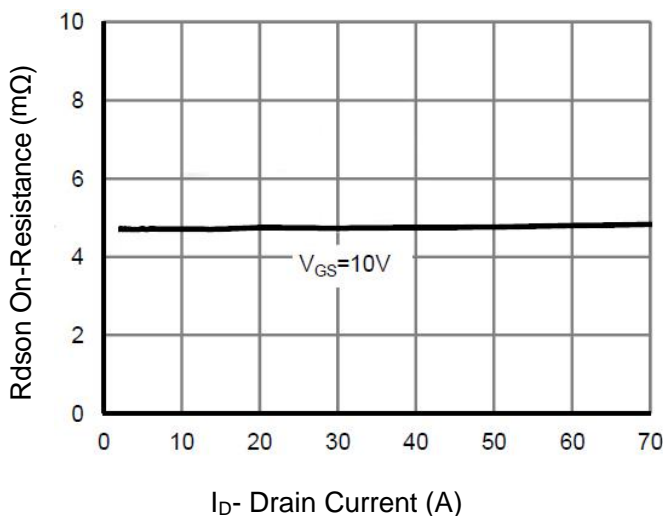

I_D - Drain Current (A)

Figure 6 Rdson vs Drain Current

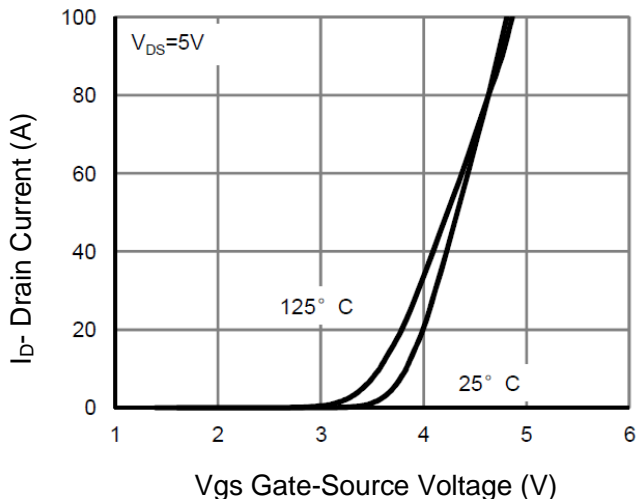

Figure 7 Transfer Characteristics

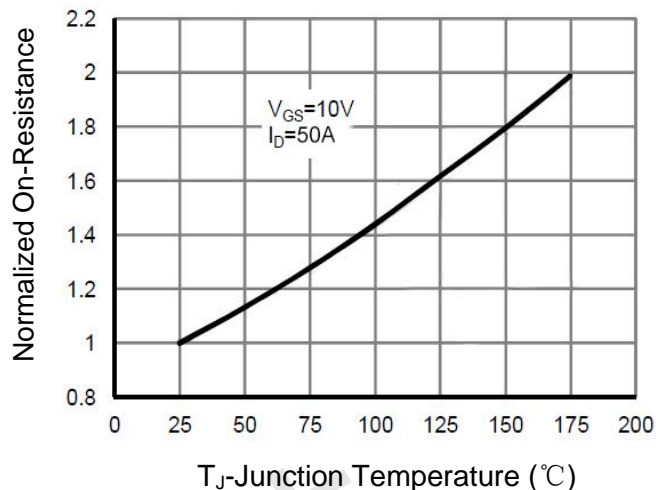

Figure 8 Rdson vs Junction Temperature

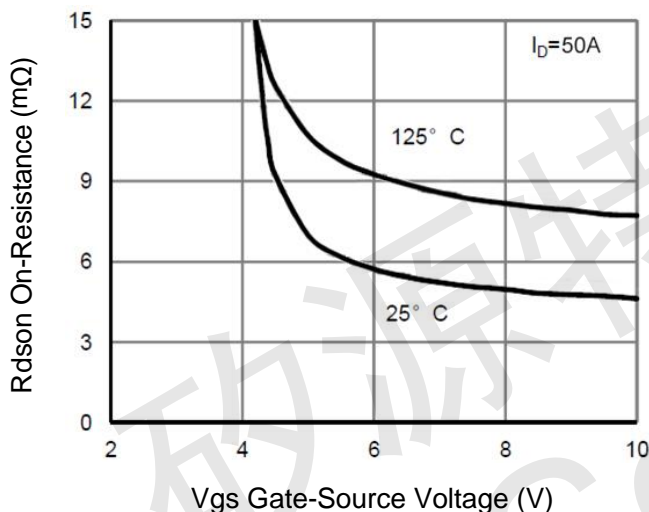

Figure 9 Rdson vs Vgs

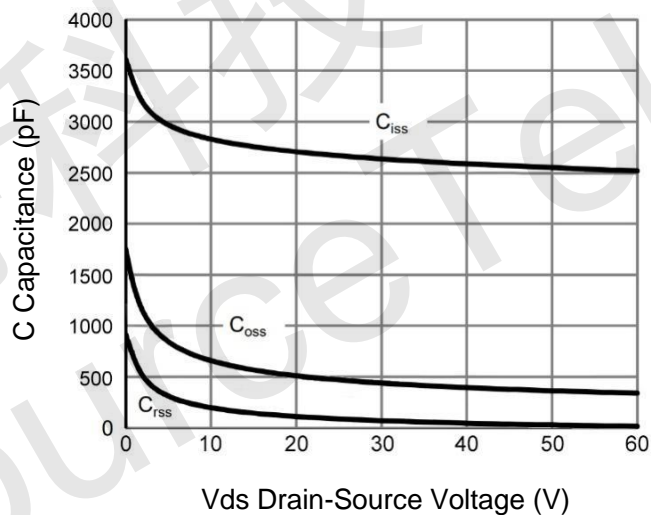

Figure 10 Capacitance vs Vds

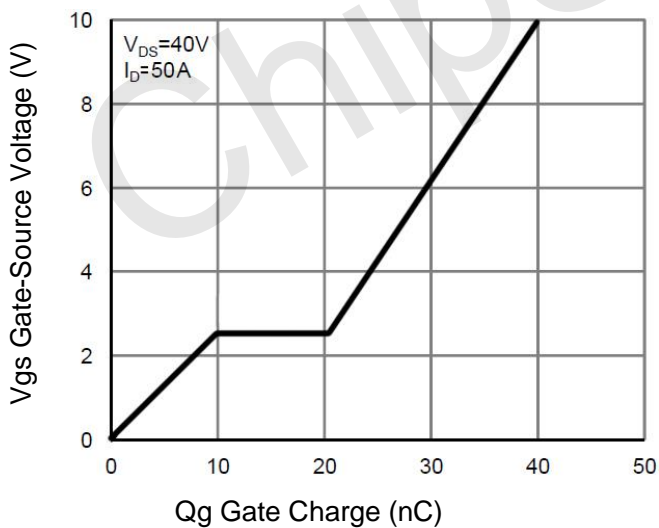

Figure 11 Gate Charge

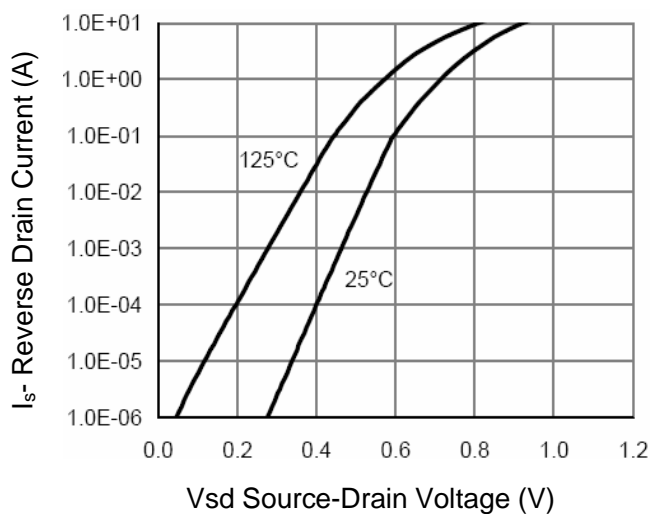

Figure 12 Source- Drain Diode Forward

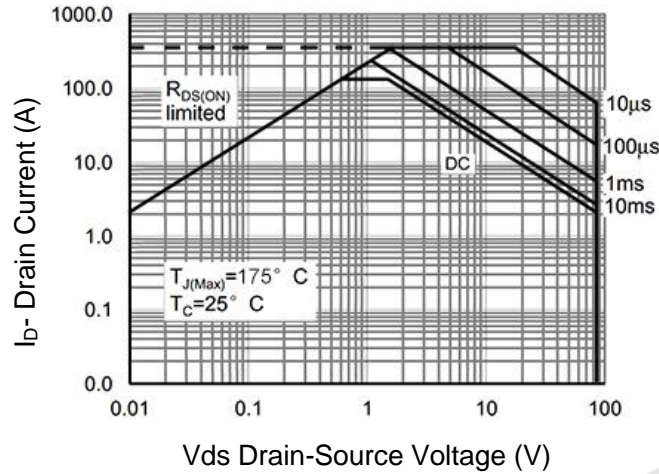

Figure 13 Safe Operation Area

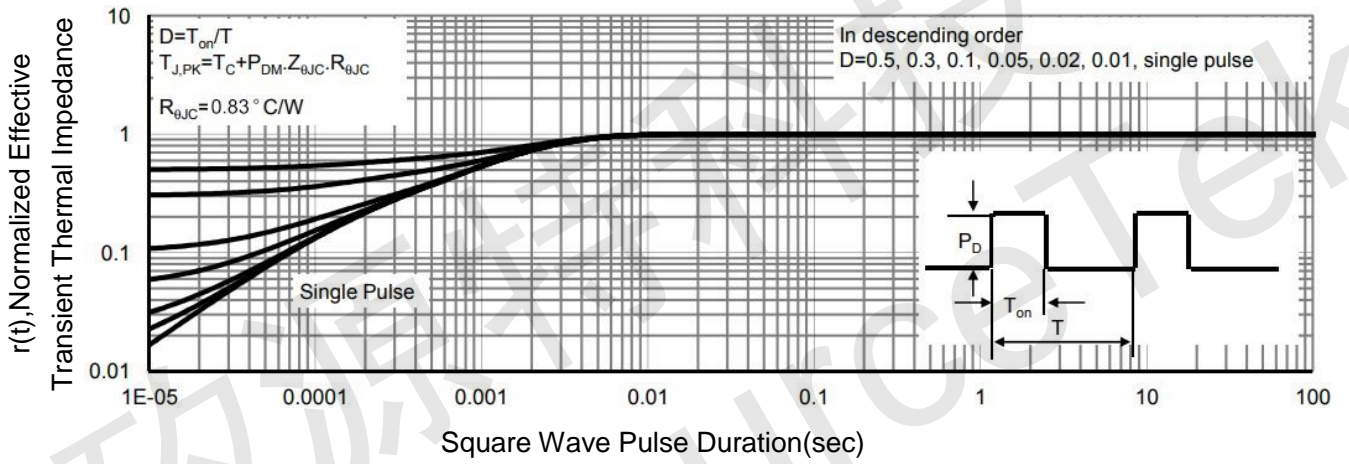
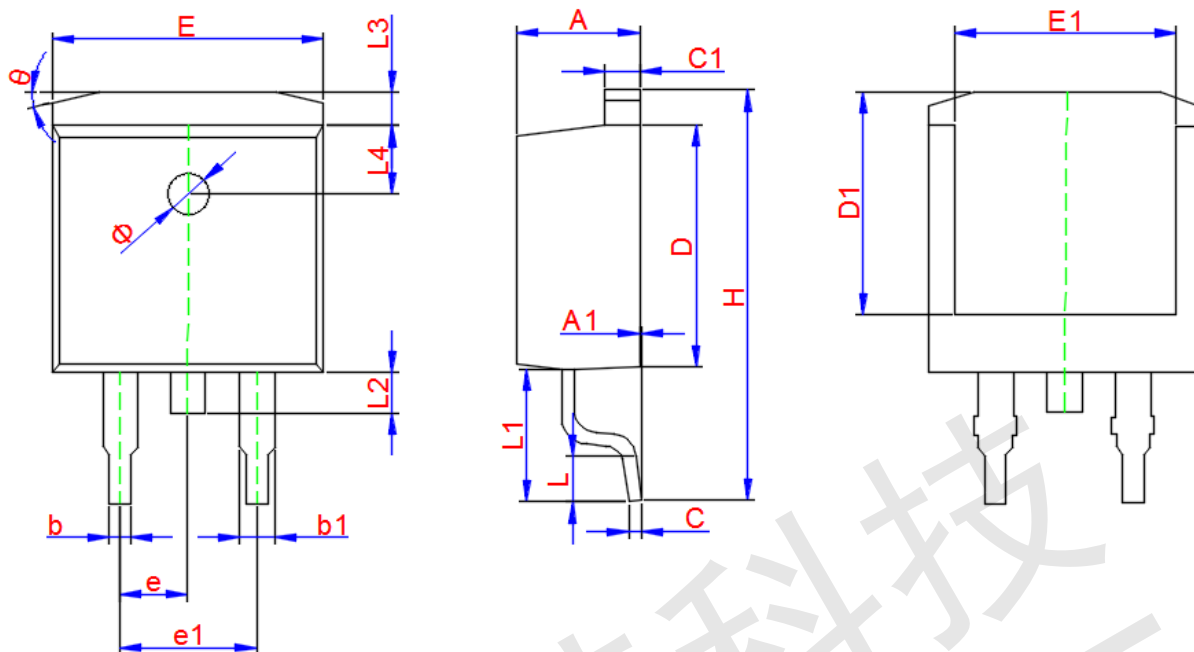

Figure 14 Normalized Maximum Transient Thermal Impedance



TO-263 Package Information



Symbol	Dimensions In Millimeters		
	Min.	Typ.	Max.
A	4.300	4.500	4.700
A1	0.000	--	0.250
b	0.700	0.800	0.900
b1	1.200	1.300	1.400
c	0.400	0.470	0.550
c1	1.250	1.300	1.350
D	9.000	9.100	9.200
D1	8.000	8.100	8.200
H	14.90	15.20	15.50
E	9.800	10.00	10.20
E1	7.850	8.000	8.150
e1	4.930	5.080	5.230
L	2.000	2.200	2.450
L1	4.600	4.800	5.000
L2	1.300	1.500	1.700
L3	1.150	1.250	1.350
L4	2.400	2.500	2.600
Φ	1.5TYP.		
e	2.54TYP.		
θ	13° TYP.		