



N-Channel Enhancement Mode Power MOSFET

Description

The PE8250M uses advanced trench technology to provide excellent $R_{DS(ON)}$ and low gate charge. It can be used in a wide variety of applications. It is ESD protected.

General Features

- $V_{DS} = 18V$, $I_D = 50A$

$$R_{DS(ON)} < 4.2m\Omega @ V_{GS}=4.5V$$

$$R_{DS(ON)} < 6m\Omega @ V_{GS}=2.5V$$

$$R_{DS(ON)} < 10m\Omega @ V_{GS}=1.8V$$

ESD Rating: 4000V HBM

- High Power and current handing capability
- Lead free product is acquired
- Surface Mount Package

Application

- PWM applications
- Load switch
- Power management
- Battery Protection

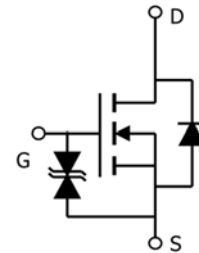

Schematic diagram

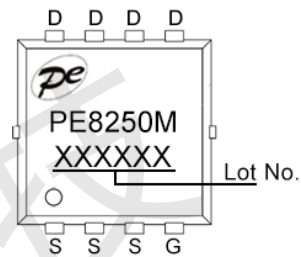

Marking and pin assignment

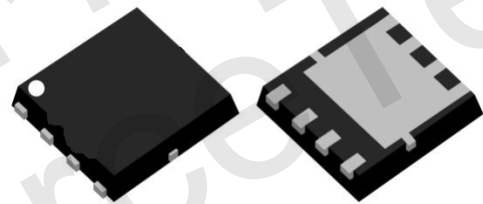

PDFN3.3x3.3-8L

Absolute Maximum Ratings (TC=25°C unless otherwise noted)

Parameter	Symbol	Rating	Unit
Drain-Source Voltage	V_{DS}	18	V
Gate-Source Voltage	V_{GS}	± 12	V
Drain Current-Continuous	I_D	50	A
Drain Current-Continuous (TC=100°C)	I_D	40	A
Pulsed Drain Current (Note 1)	I_{DM}	200	A
Maximum Power Dissipation	P_D	36	W
Avalanche Current	I_{AS}	40	A
Avalanche Energy (L=0.1mH)	E_{AS}	80	mJ
Operating Junction and Storage Temperature Range	T_J, T_{STG}	-55 To 150	°C

Thermal Characteristic

Thermal Resistance, Junction-to-Ambient (Note 2)	$R_{\theta JA}$	3.5	°C/W
--	-----------------	-----	------



Electrical Characteristics (TC=25°C unless otherwise noted)

Parameter	Symbol	Condition	Min	Typ	Max	Unit
Off Characteristics						
Drain-Source Breakdown Voltage	BV_{DSS}	$V_{GS}=0V, I_D=250\mu A$	-	18	-	V
Zero Gate Voltage Drain Current	I_{DSS}	$V_{DS}=16V, V_{GS}=0V$	-	-	1	μA
Gate-Body Leakage Current	I_{GSS}	$V_{GS}=\pm 10V, V_{DS}=0V$	-	-	± 10	μA
On Characteristics (Note 3)						
Gate Threshold Voltage	$V_{GS(th)}$	$V_{DS}=V_{GS}, I_D=250\mu A$	0.45	0.7	1.0	V
Drain-Source On-State Resistance	$R_{DS(on)}$	$V_{GS}=4.5V, I_D=15A$	-	3.5	4.2	$m\Omega$
		$V_{GS}=2.5V, I_D=7A$	-	4.7	6	$m\Omega$
		$V_{GS}=1.8V, I_D=2A$	-	7	10	$m\Omega$
Forward Transconductance	g_{FS}	$V_{DS}=5V, I_D=20A$	-	100	-	S
Dynamic Characteristics (Note 4)						
Input Capacitance	C_{iss}	$V_{DS}=10V, V_{GS}=0V,$ $F=1.0MHz$	-	2300	-	pF
Output Capacitance	C_{oss}		-	560	-	pF
Reverse Transfer Capacitance (Note 4)	C_{rss}		-	500	-	pF
Gate Resistance	R_g	$V_{DS}=0V, V_{GS}=0V, F=1.0MHz$	-	0.5	-	K Ω
Switching Characteristics						
Turn-on Delay Time	$t_{d(on)}$	$V_{DD}=10V, R_L=1\Omega,$ $V_{GS}=4.5V, R_G=3\Omega$	-	7.5	-	nS
Turn-on Rise Time	t_r		-	15	-	nS
Turn-Off Delay Time	$t_{d(off)}$		-	72	-	nS
Turn-Off Fall Time	t_f		-	21	-	nS
Total Gate Charge	Q_g	$V_{DS}=10V, I_D=20A,$ $V_{GS}=4.5V$	-	36	-	nC
Gate-Source Charge	Q_{gs}		-	5.6	-	nC
Gate-Drain Charge	Q_{gd}		-	11	-	nC
Drain-Source Diode Characteristics						
Diode Forward Voltage (Note 3)	V_{SD}	$V_{GS}=0V, I_S=1A$	-	-	1.2	V
Diode Forward Current (Note 2)	I_S		-	-	20	A

Notes:

1. Repetitive Rating: Pulse width limited by maximum junction temperature.
2. Surface Mounted on FR4 Board, $t \leq 10$ sec.
3. Pulse Test: Pulse Width $\leq 300\mu s$, Duty Cycle $\leq 2\%$.
4. Guaranteed by design, not subject to product.



Typical Electrical and Thermal Characteristics

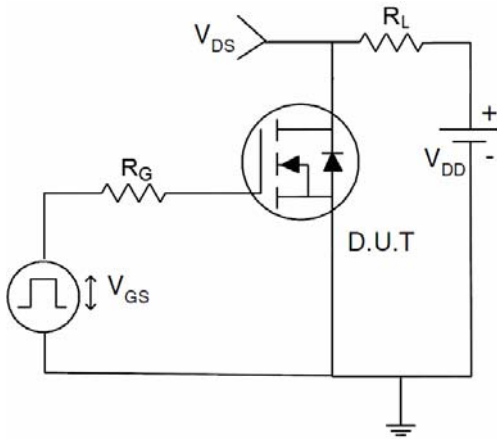

Figure 1 Switching Test Circuit

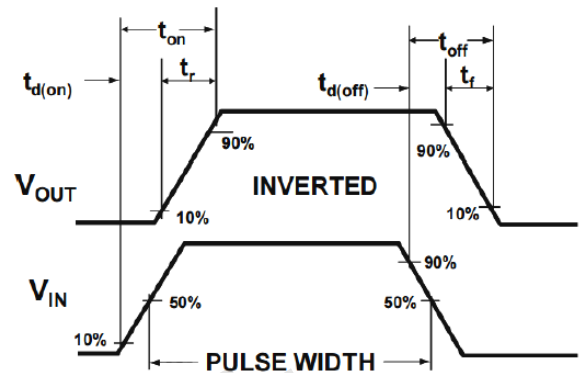

Figure 2 Switching Waveform

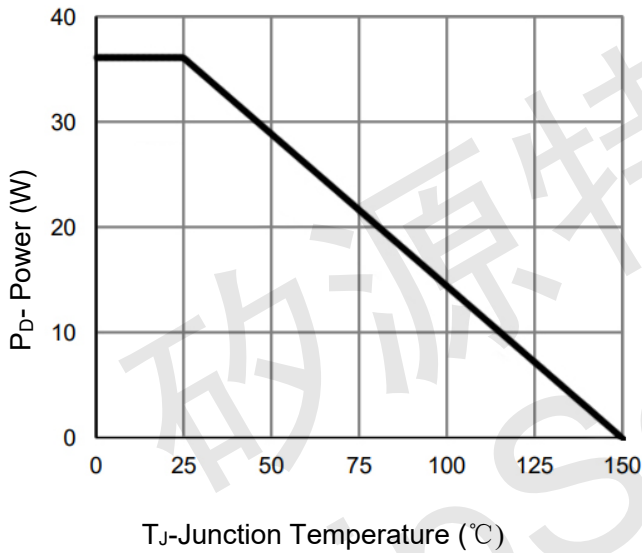

Figure 3 Power Dissipation

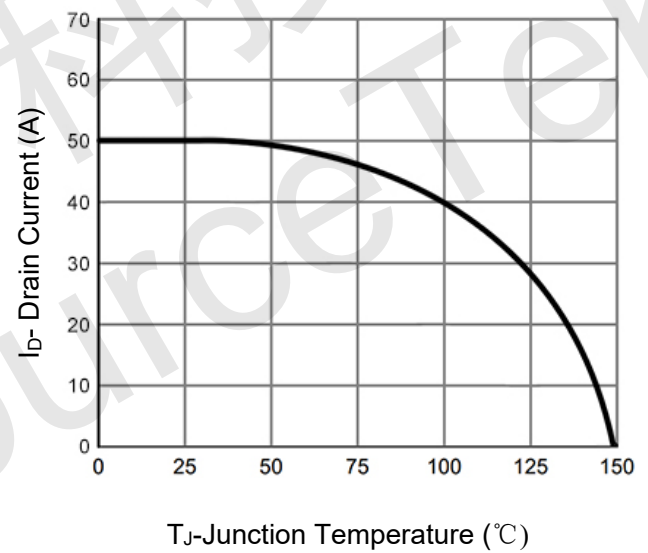

Figure 4 Drain Current

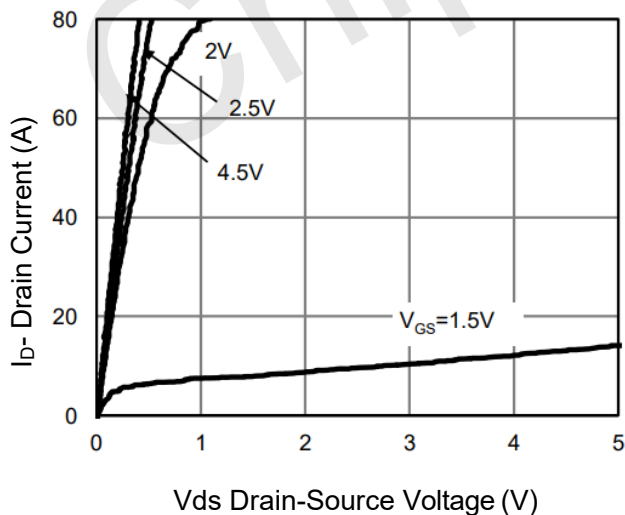

Figure 5 Output Characteristics

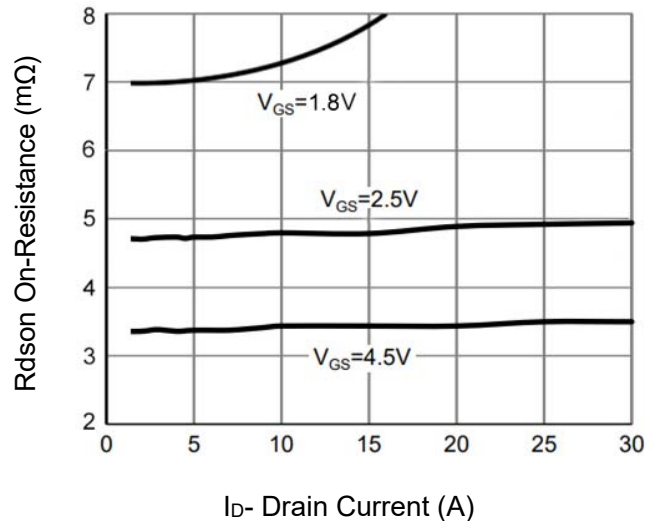

Figure 6 R_dson vs Drain Current

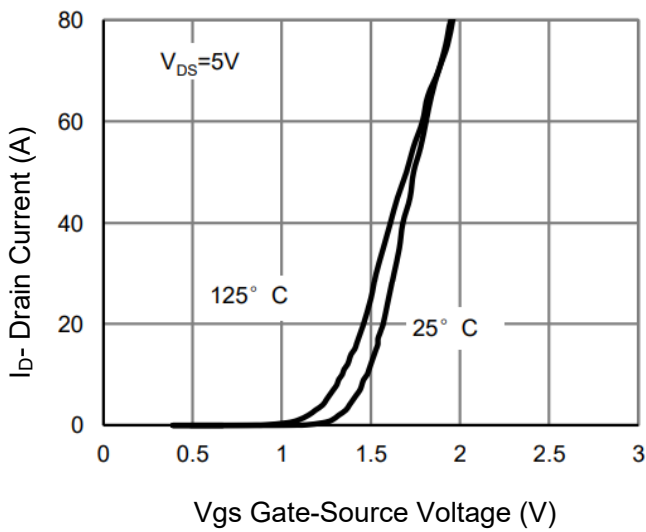

Figure 7 Transfer Characteristics

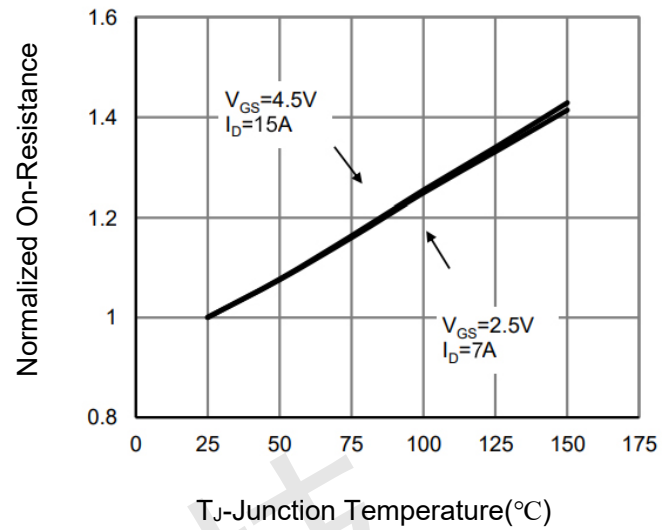

Figure 8 Rdson vs Junction Temperature

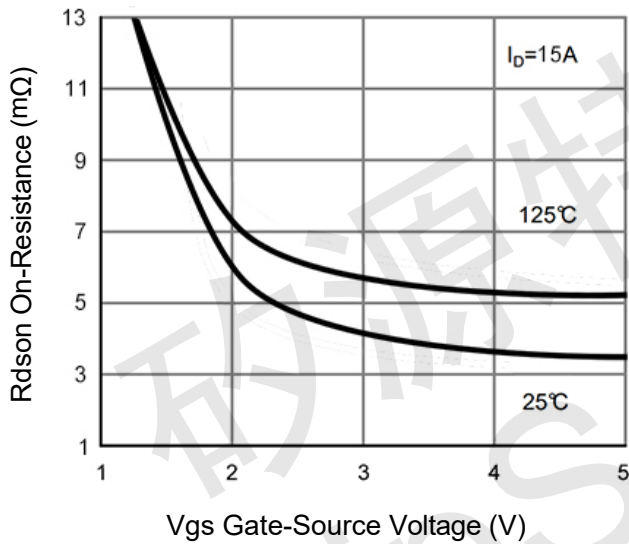

Figure 9 Rdson vs Vgs

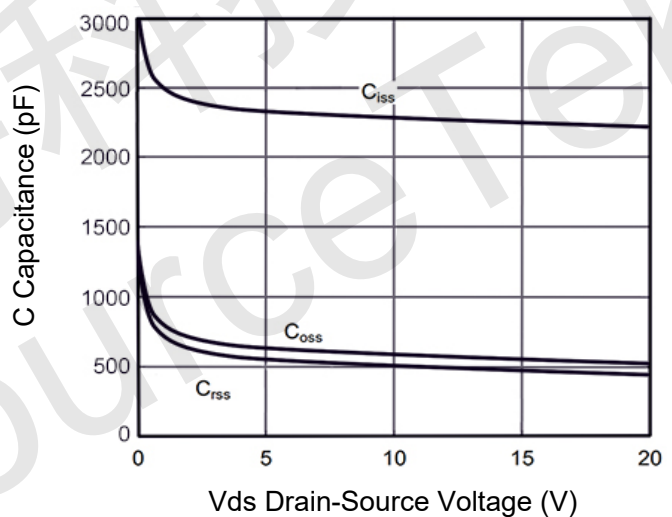

Figure 10 Capacitance vs Vds

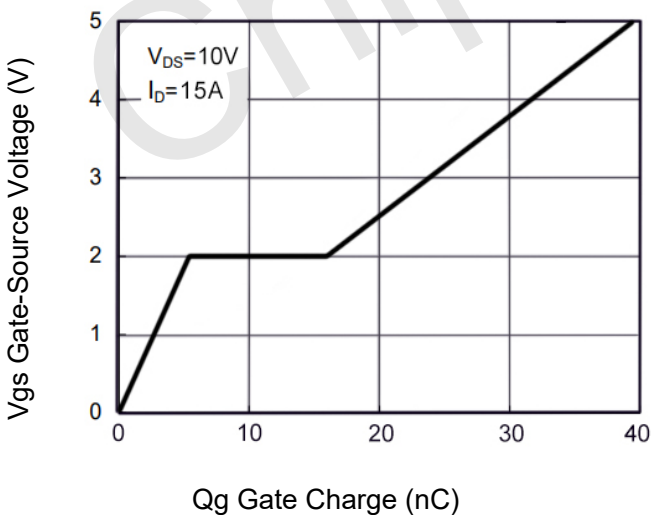

Figure 11 Gate Charge

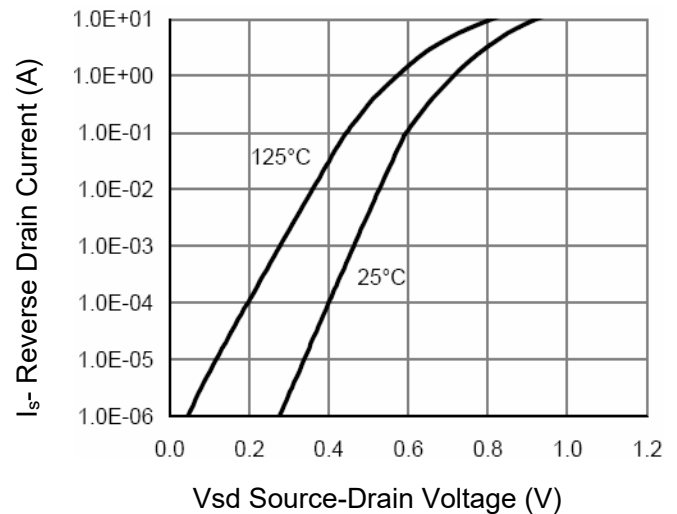

Figure 12 Source- Drain Diode Forward

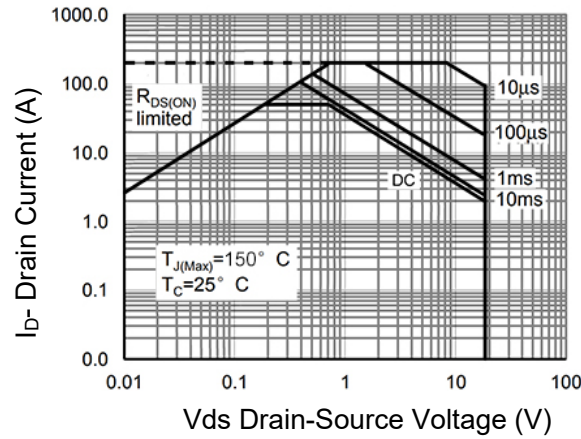

Figure 13 Safe Operation Area

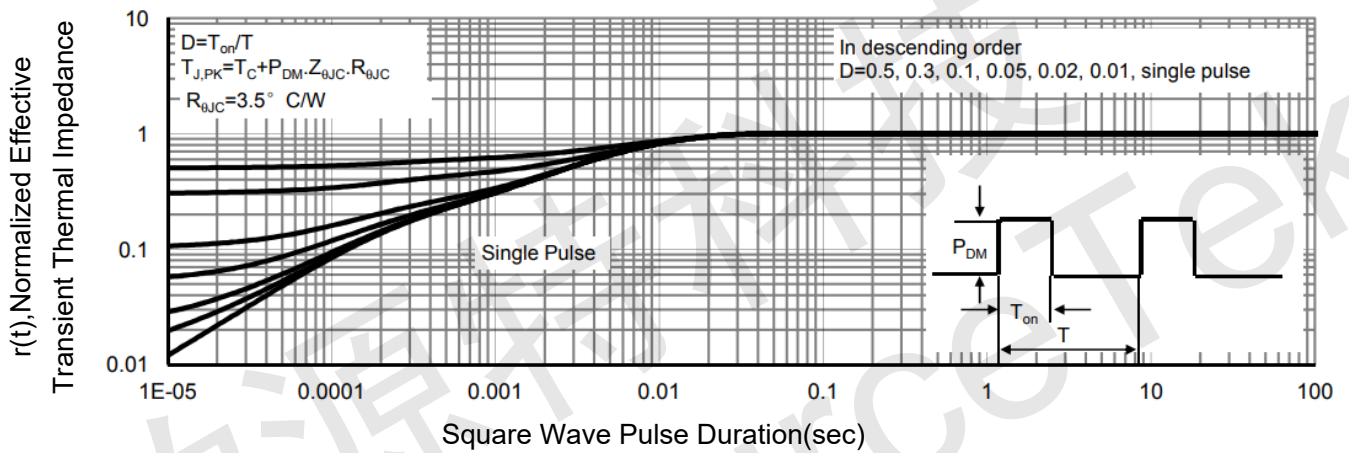
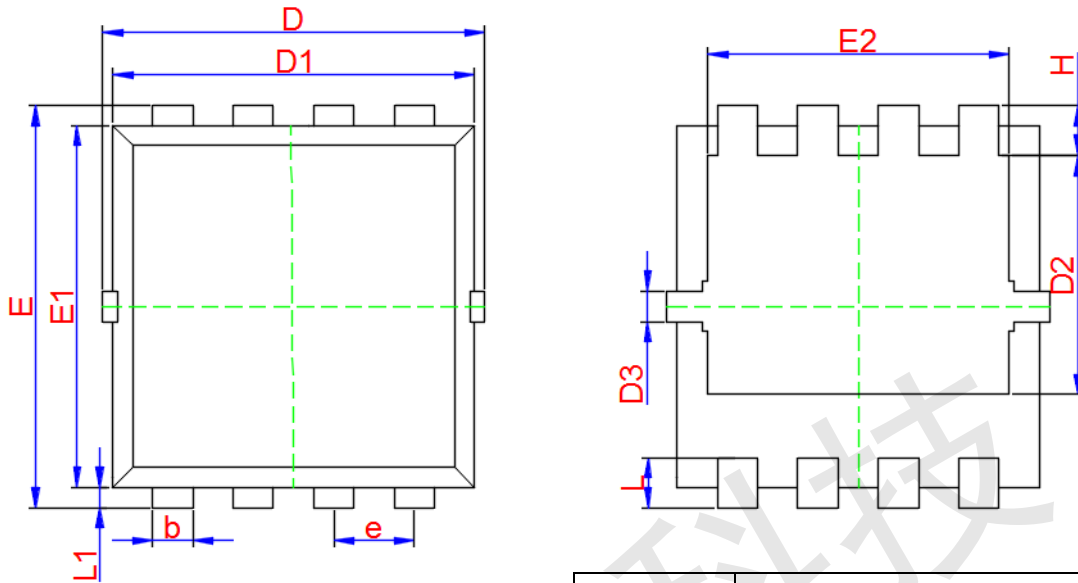

Figure 14 Normalized Maximum Transient Thermal Impedance



PDFN3.3x3.3-8L Package Information



Symbol	Dimensions In Millimeters		
	Min.	Typ.	Max.
A	0.700	0.775	0.850
b	0.250	0.300	0.350
c	0.100	0.150	0.250
D	3.150	3.300	3.400
D1	2.950	3.100	3.200
D2	1.700	1.800	1.930
D3	-	0.130	-
E	3.050	3.250	3.350
E1	2.950	3.150	3.200
E2	2.300	2.400	2.550
e	0.650 TYP.		
H	0.330	0.430	0.530
L	0.300	0.400	0.500
L1	0.080	0.130	0.180
θ	-	10°	-