



SIO2622E v1.0

General Features

V _{DSS}	I _D	R _{DS(ON)} (mΩ) Typ
20V	6A	17 @ V _{GS} =4.5V
		21 @ V _{GS} =2.5V

Description

The SIO2622E uses advanced trench technology to provide excellent R_{DS(ON)}, low gate charge and operation with gate voltages as low as 1.8V. This device is suitable for use as a load switch or in PWM applications .It is ESD protested.

ESD Rating:2000VBM

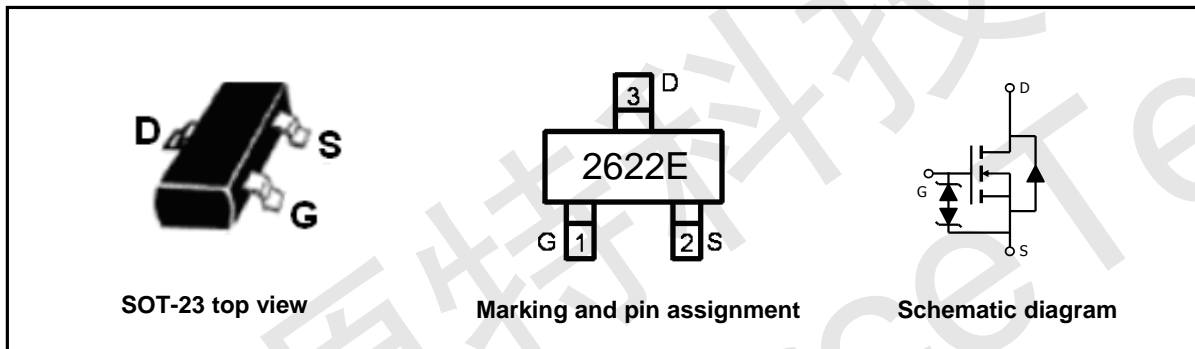

ABSOLUTE MAXIMUM RATINGS(TA=25°C unless otherwise noted)

Parameter	Symbol	Limit	Unit
Drain-Source Voltage	V _{DS}	20	V
Gate-Source Voltage	V _{GS}	±10	V
Drain Current-Continuous@ Current-Pulsed (Note 1)	I _D	6	A
	I _{DM}	30	A
Maximum Power Dissipation	P _D	1.4	W
Operating Junction and Storage Temperature Range	T _J ,T _{STG}	-55 To 150	°C

THERMAL CHARACTERISTICS

Thermal Resistance,Junction-to-Ambient (Note 2)	R _{θJA}	89.3	°C/W
---	------------------	------	------

Electrical Characteristics (TA=25°C unless otherwise noted)

Parameter	Symbol	Condition	Min	Typ	Max	Unit
Off Characteristics						
Drain-Source Breakdown Voltage	BV _{DSS}	V _{GS} =0V I _D =250μA	20		-	V
Zero Gate Voltage Drain Current	I _{DSS}	V _{DS} =20V,V _{GS} =0V	-	-	1	μA



Gate-Body Leakage Current	I_{GSS}	$V_{GS}=\pm 10V, V_{DS}=0V$	-	-	± 10	μA
On Characteristics (Note 3)						
Gate Threshold Voltage	$V_{GS(th)}$	$V_{DS}=V_{GS}, I_D=250\mu A$	0.45	0.7	1.0	V
Drain-Source On-State Resistance	$R_{DS(ON)}$	$V_{GS}=4.5V, I_D=6A$	-	17	22	$m\Omega$
		$V_{GS}=2.5V, I_D=5A$	-	21	26	$m\Omega$
Forward Transconductance	g_{FS}	$V_{DS}=5V, I_D=4.5A$	11	-	-	S
Dynamic Characteristics (Note4)						
Input Capacitance	C_{ISS}	$V_{DS}=10V, V_{GS}=0V,$ $F=1.0MHz$	-	660	-	PF
Output Capacitance	C_{OSS}		-	160	-	PF
Reverse Transfer Capacitance	C_{RSS}		-	87	-	PF
Switching Characteristics (Note 4)						
Turn-on Delay Time	$t_{d(on)}$	$V_{DD}=10V, R_L=1.5\Omega$ $V_{GS}=5V, R_{GEN}=3\Omega$	-	0.5		nS
Turn-on Rise Time	t_r		-	1		nS
Turn-Off Delay Time	$t_{d(off)}$		-	12		nS
Turn-Off Fall Time	t_f		-	4		nS
Total Gate Charge	Q_g	$V_{DS}=10V, I_D=6A,$ $V_{GS}=4.5V$	-	8		nC
Gate-Source Charge	Q_{gs}		-	2.5	-	nC
Gate-Drain Charge	Q_{gd}		-	3	-	nC
Drain-Source Diode Characteristics						
Diode Forward Voltage (Note 3)	V_{SD}	$V_{GS}=0V, I_S=1A$	-	-	1.2	V
Diode Forward Current (Note 2)	I_S		-	-	6	A

Notes:

1. Repetitive Rating: Pulse width limited by maximum junction temperature.
2. Surface Mounted on FR4 Board, $t \leq 10$ sec.
3. Pulse Test: Pulse Width $\leq 300\mu s$, Duty Cycle $\leq 2\%$.
4. Guaranteed by design, not subject to production



TYPICAL ELECTRICAL AND THERMAL CHARACTERISTICS

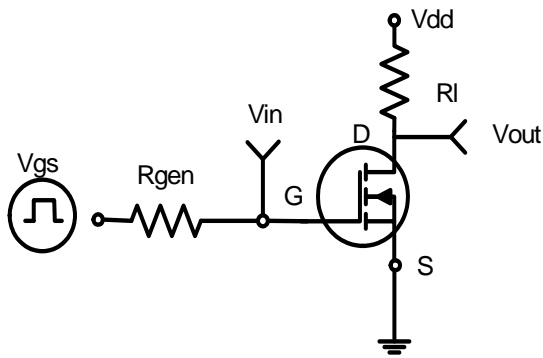

Figure 1: Switching Test Circuit

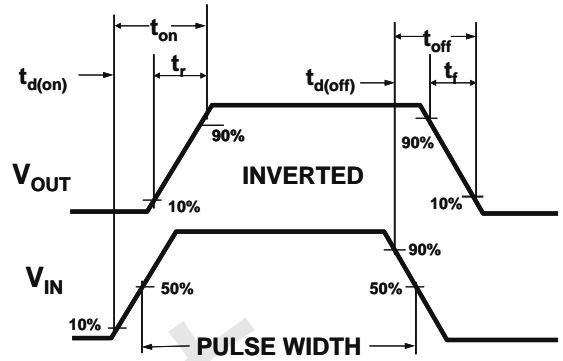

Figure 2: Switching Waveforms

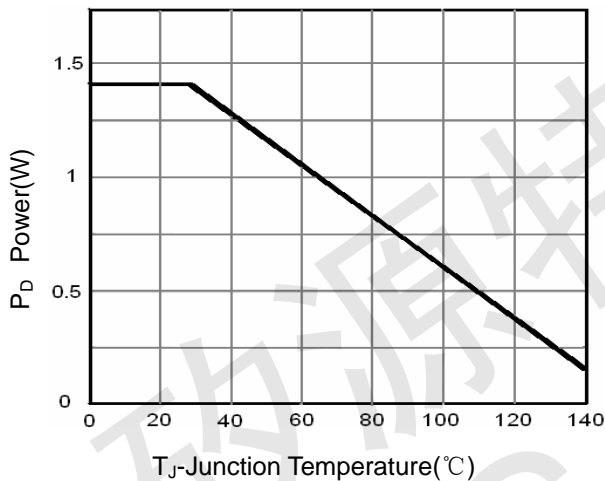

Figure 3 Power Dissipation

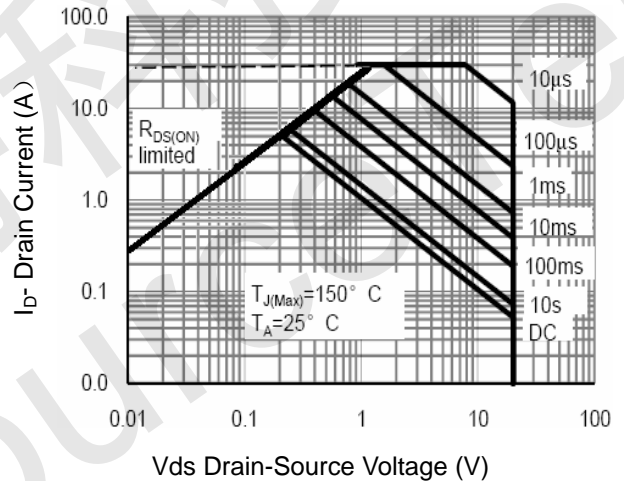

Figure 4 Safe Operation Area

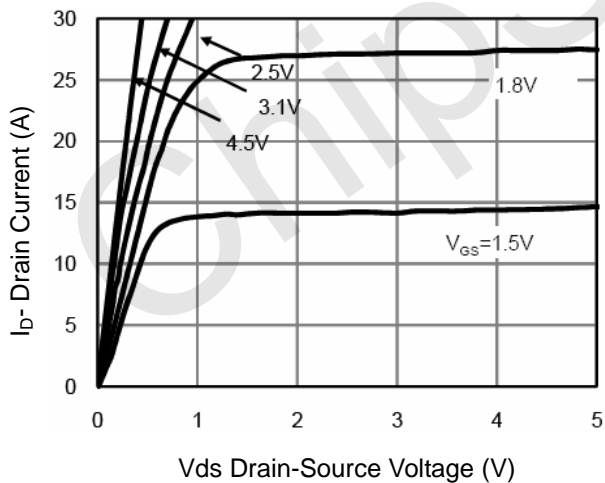

Figure 5 Output CHARACTERISTICS

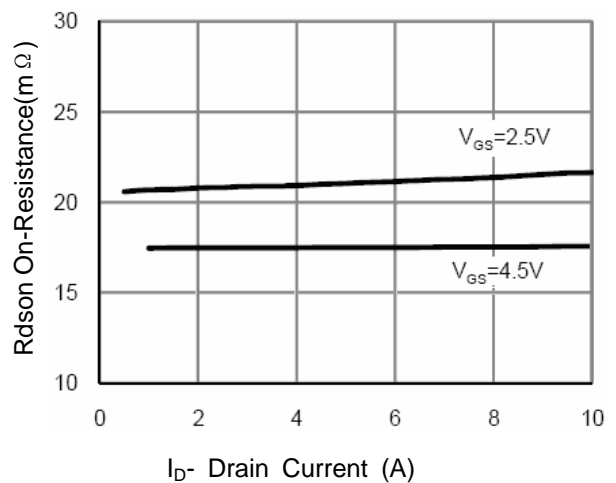

Figure 6 Drain-Source On-Resistance

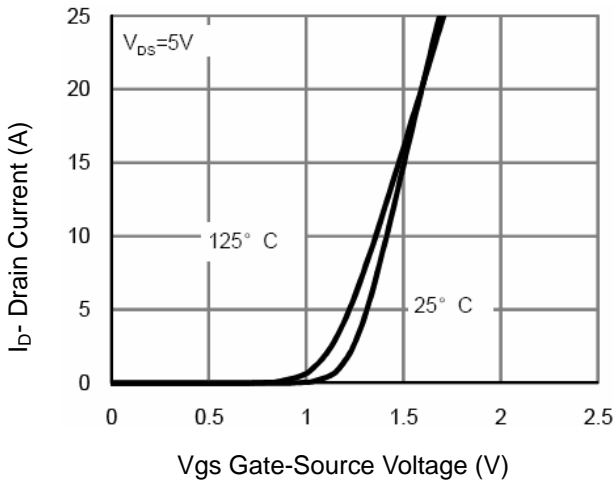

Figure 7 Transfer Characteristics

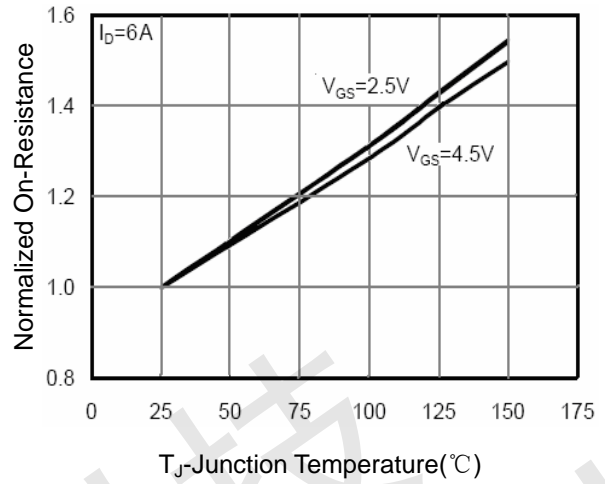

Figure 8 Drain-Source On-Resistance

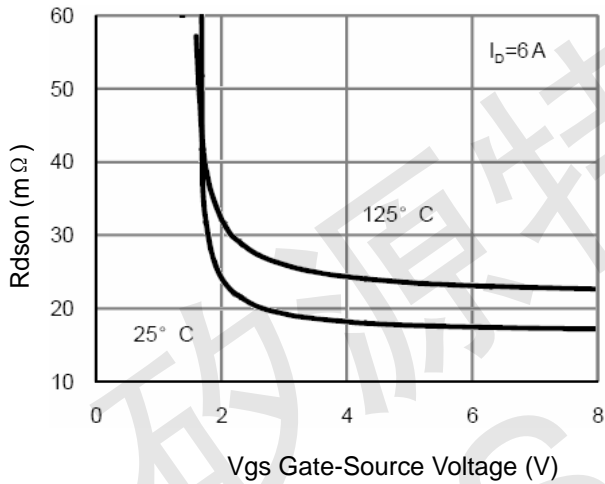

Figure 9 Rds(on) vs Vgs

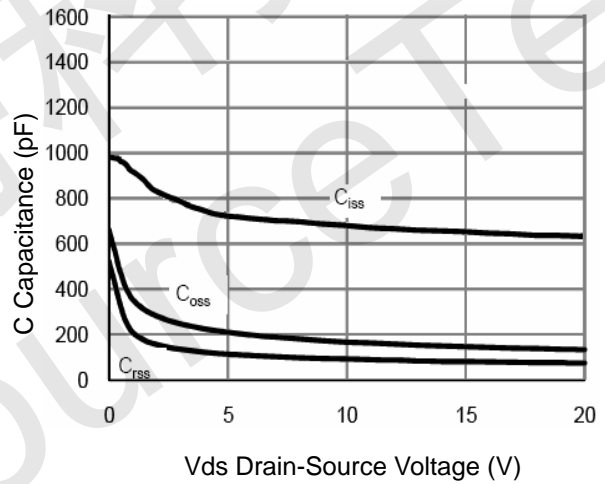

Figure 10 Capacitance vs Vds

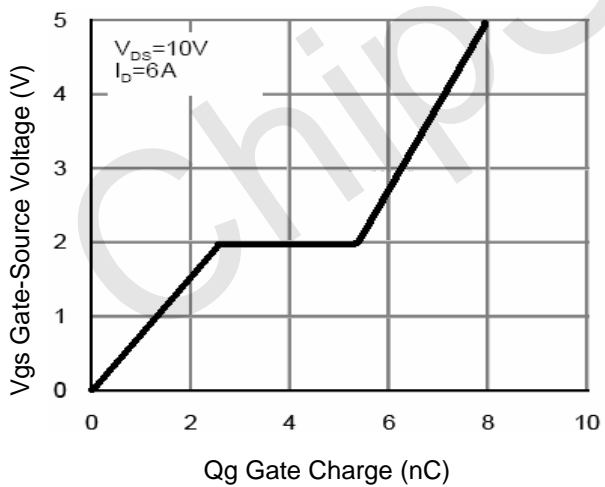

Figure 11 Gate Charge

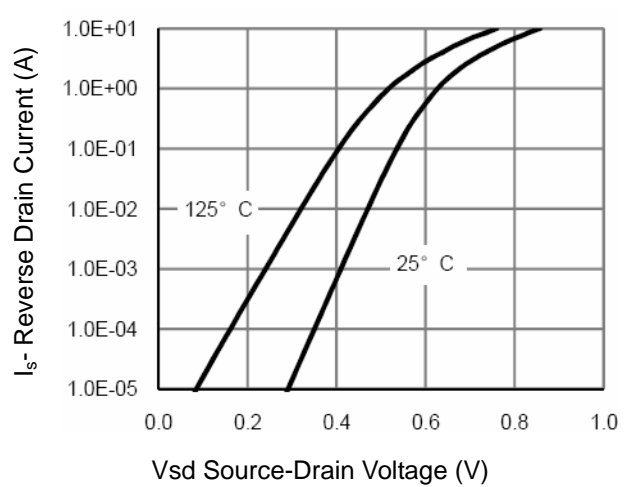

Figure 12 Source- Drain Diode Forward

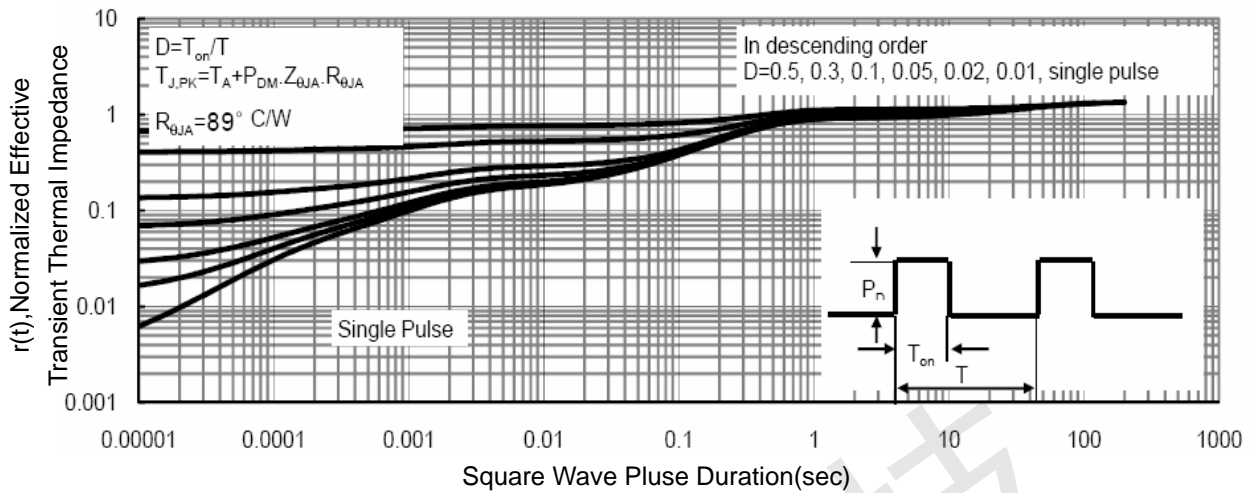
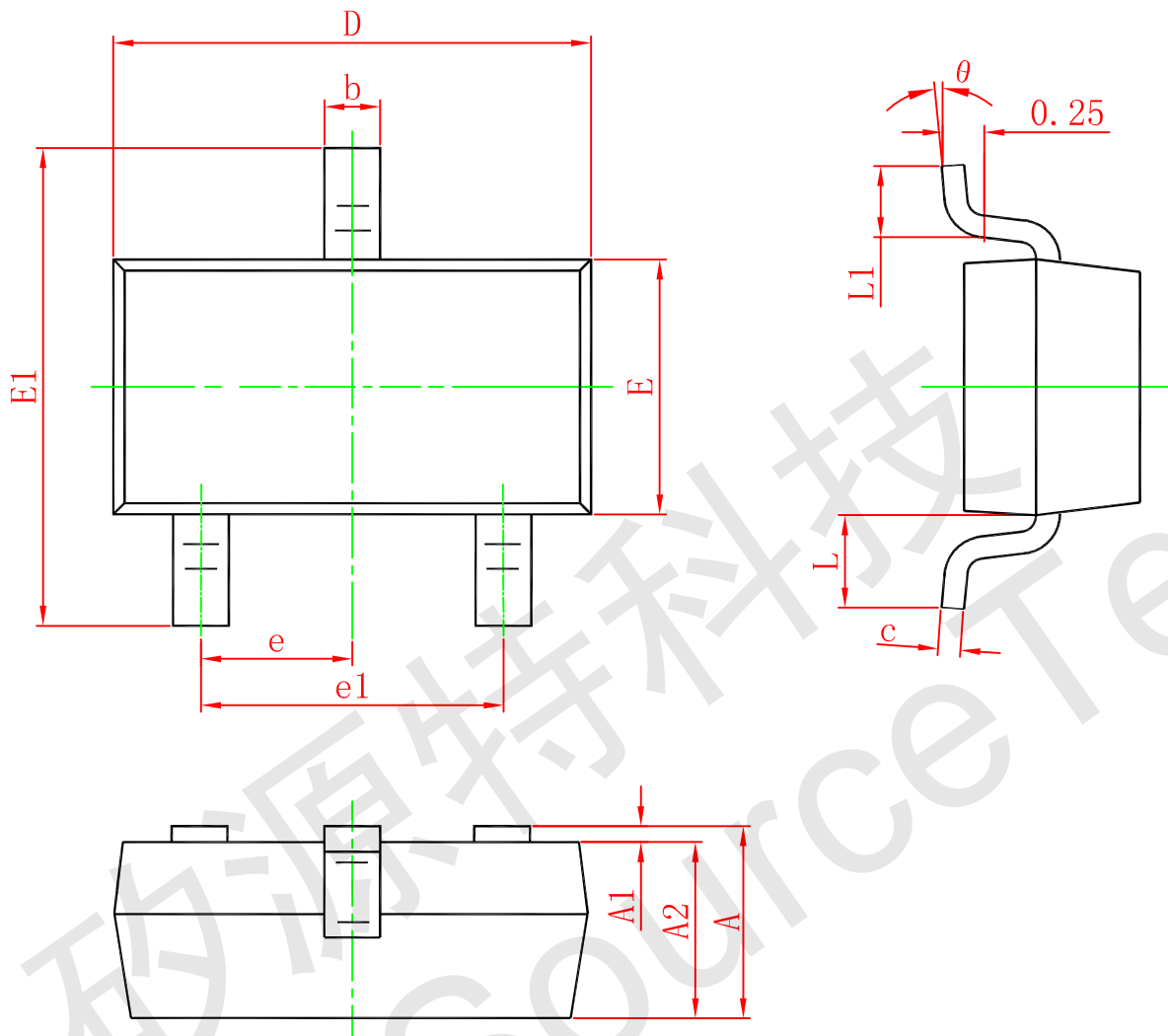

Figure 13 Normalized Maximum Transient Thermal Impedance



SOT-23 PACKAGE OUTLINE DIMENSIONS



Symbol	Dimensions In Millimeters		Dimensions In Inches	
	Min.	Max.	Min.	Max.
A	0.900	1.150	0.035	0.045
A1	0.000	0.100	0.000	0.004
A2	0.900	1.050	0.035	0.041
b	0.300	0.500	0.012	0.020
c	0.080	0.150	0.003	0.006
D	2.800	3.000	0.110	0.118
E	1.200	1.400	0.047	0.055
E1	2.250	2.550	0.089	0.100
e	0.950 TYP.		0.037 TYP.	
e1	1.800	2.000	0.071	0.079
L	0.550 REF.		0.022 REF.	
L1	0.300	0.500	0.012	0.020
θ	0°	8°	0°	8°