



30V Complementary Enhancement Mode MOSFET

DESCRIPTION

The UM4606 is the complementary enhancement mode power field effect transistor is produced using high cell density advanced trench technology to provide excellent $R_{DS(ON)}$.

This device is suitable for use as a load switch or in PWM and gate charge for most of the synchronous buck converter applications

FEATURE

- ◆ 30V/7.0A, $R_{DS(ON)}=21m\Omega$ @ $V_{GS}=10V$ N_CH
- ◆ -30V/-6.0A, $R_{DS(ON)}=33m\Omega$ @ $V_{GS}=-10V$ P_CH
- ◆ 30V/5.0A, $R_{DS(ON)}=34m\Omega$ @ $V_{GS}=4.5V$ N_CH
- ◆ -30V/-5.0A, $R_{DS(ON)}=38m\Omega$ @ $V_{GS}=-4.5V$ P_CH
- ◆ Super high design for extremely low $R_{DS(ON)}$
- ◆ Exceptional on-resistance and Maximum DC current capability
- ◆ Full RoHS compliance
- ◆ SOP8 package design

APPLICATIONS

- ◆ High Frequency Point-of-Load Synchronous
- ◆ New working DC-DC Power System
- ◆ Load Switch

PIN CONFIGURATION

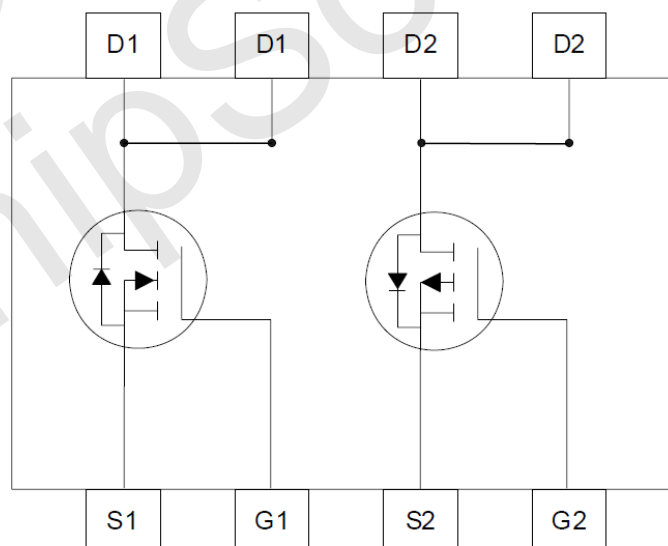

UM4606 Rev B 28/July/2010

TEL: +86-0755-27595155 27595165

FAX: +86-0755-27594792

WEB: [Http://www.ChipSourceTek.com](http://www.ChipSourceTek.com)

E-mail: Tony.Wang@.ChipSourceTek.com InFo@ChipSourceTek.com



■ **PART NUMBER INFORMATION**

UM4606A-BB C	A= Package Code S: SOP BB=Handing Code TR: Tape&Reel C=Lead Plating Code G: Green Product
--------------	--

■ **ORDERING INFROMATION**

Part Number	Package Code	Package	Shipping
UM4606S-TR	S	SOP8	3000EA / T&R

- ※ Year Code : 0~9
- ※ Week Code : A~Z
- ※ G : Green Product. This product is RoHS compliant.

■ **ABSOLUTE MAXIMUM RATINGS ($T_A = 25^\circ\text{C}$ Unless otherwise noted)**

Symbol	Parameter	N-Channel	P-Channel	Unit
V_{DSS}	Drain-Source Voltage	30	-30	V
V_{GSS}	Gate-Source Voltage	± 20	± 20	V
I_D	Continuous Drain Current ($T_A=25^\circ\text{C}$)	7	-6	A
	Continuous Drain Current ($T_A=70^\circ\text{C}$)			
I_{DM}	Pulsed Drain Current	30	-30	A
P_D	Power Dissipation	$T_A=25^\circ\text{C}$	1	W
		$T_A=70^\circ\text{C}$	0.8	
T_J	Operation Junction Temperature	-55~150	-55~150	$^\circ\text{C}$
T_{STG}	Storage Temperature Range	-55~150	-55~150	$^\circ\text{C}$

Note: Absolute maximum ratings are those values beyond which the device could be permanently damaged. Absolute maximum ratings are stress rating only and functional device operation is not implied



■ **N Channel ELECTRICAL CHARACTERISTICS** ($T_A=25^\circ\text{C}$ Unless otherwise noted)

Symbol	Parameter	Condition	Min	Typ	Max	Unit
Static Parameters						
$V_{(BR)DSS}$	Drain-Source Breakdown Voltage	$V_{GS}=0V, I_D=250\mu A$	30			V
$V_{GS(th)}$	Gate Threshold Voltage	$V_{DS}=V_{GS}, I_D=250\mu A$	1.0	1.5	3.0	V
I_{GSS}	Gate Leakage Current	$V_{DS}=0V, V_{GS}=\pm 20V$			± 100	nA
I_{DSS}	Zero Gate Voltage Drain Current	$V_{DS}=24V, V_{GS}=0$			1	uA
		$V_{DS}=24V, V_{GS}=0$ $T_J=55^\circ\text{C}$			30	
$R_{DS(ON)}$	Drain-Source On-Resistance	$V_{GS}=10V, I_D=7A$		21	30	m Ω
		$V_{GS}=4.5V, I_D=5A$		34	40	
g_{FS}	Forward Transconductance	$V_{DS}=5V, I_D=5A$		7.3		S
Source-Drain Diode						
V_{SD}	Diode Forward Voltage	$I_S=1.7A, V_{GS}=0V$		0.76	1.0	V
Dynamic Parameters						
Q_g	Total Gate Charge	$V_{DS}=15V$		92		nC
Q_{gs}	Gate-Source Charge	$V_{GS}=5V$		8.4		
Q_{gd}	Gate-Drain Charge	$I_D=7A$		7.3		
C_{iss}	Input Capacitance	$V_{DS}=15V$		407		pF
C_{oss}	Output Capacitance	$V_{GS}=0V$		113		
C_{rss}	Reverse Transfer Capacitance	$f=1\text{MHz}$		57		
$T_{d(on)}$	Turn-On Time	$V_{DS}=15V$		4.5	18	nS
T_r		$V_{GS}=10V$		2.1		
$T_{d(off)}$	Turn-Off Time	$R_G=6\Omega$		19	70	
T_f		$R_L=15\Omega$		8.2		

Note: 1. Pulse test: pulse width \leq 300uS, duty cycle \leq 2%

2.Static parameters are based on package level with recommended wire bonding



■ **P Channel ELECTRICAL CHARACTERISTICS** ($T_A=25^\circ\text{C}$ Unless otherwise noted)

Symbol	Parameter	Condition	Min	Typ	Max	Unit
Static Parameters						
$V_{(BR)DSS}$	Drain-Source Breakdown Voltage	$V_{GS}=0V, I_D=-250\mu A$	-30			V
$V_{GS(th)}$	Gate Threshold Voltage	$V_{DS}=V_{GS}, I_D=-250\mu A$	-1.0	-1.5	-3.0	V
I_{GSS}	Gate Leakage Current	$V_{DS}=0V, V_{GS}=\pm 20V$			± 100	nA
I_{DSS}	Zero Gate Voltage Drain Current	$V_{DS}=-24V, V_{GS}=0$			-1	uA
		$V_{DS}=-24V, V_{GS}=0$ $T_J=55^\circ\text{C}$			-30	
$R_{DS(ON)}$	Drain-Source On-Resistance	$V_{GS}=-10V, I_D=-6A$		33	40	m Ω
		$V_{GS}=-4.5V, I_D=-5A$		38	50	
g_{FS}	Forward Transconductance	$V_{DS}=-5V, I_D=-4A$		21.7		S
Source-Drain Diode						
V_{SD}	Diode Forward Voltage	$I_S=-1.0A, V_{GS}=0V$		-0.77	-1.0	V
Dynamic Parameters						
Q_g	Total Gate Charge	$V_{DS}=-15V$		78		nC
Q_{gs}	Gate-Source Charge	$V_{GS}=-10V$		6.32		
Q_{gd}	Gate-Drain Charge	$I_D=-5.0A$		8.2		
C_{iss}	Input Capacitance	$V_{DS}=-15V$		950		pF
C_{oss}	Output Capacitance	$V_{GS}=0V$		137		
C_{rss}	Reverse Transfer Capacitance	$f=1\text{MHz}$		118		
$T_{d(on)}$	Turn-On Time	$V_{DS}=-15V$		8		nS
T_r		$V_{GS}=-10V$		3.5		
$T_{d(off)}$	Turn-Off Time	$R_G=6\Omega$		22		
T_f		$R_L=15\Omega$		4		



■ **N Channel TYPICAL CHARACTERISTICS** (25°C Unless Note)

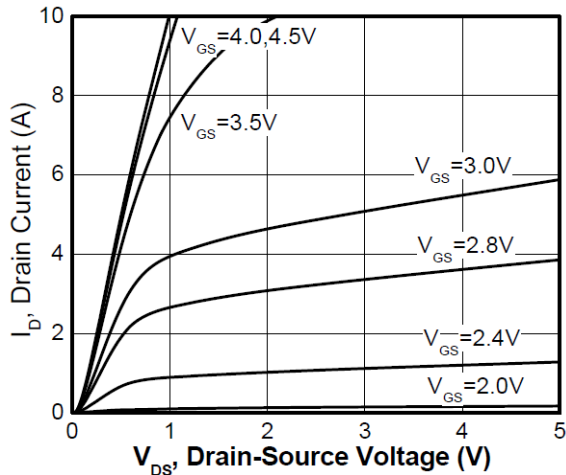

Figure 1. Output Characteristics

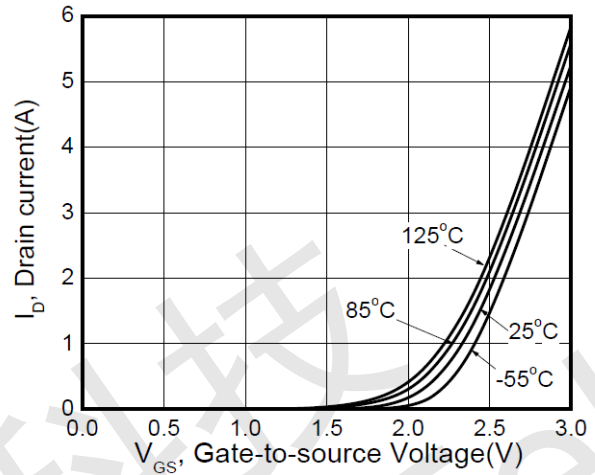

Figure 2. Transfer Characteristics

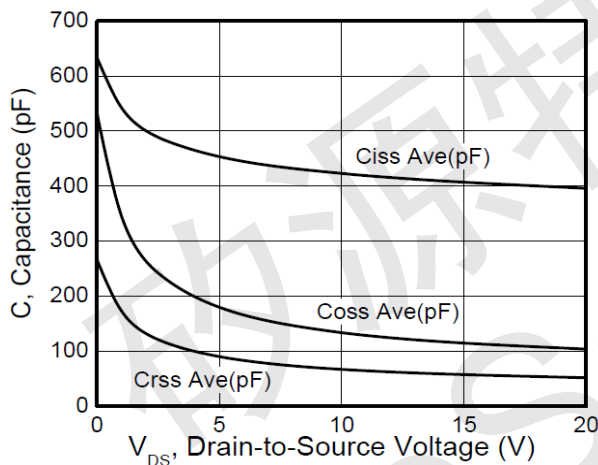

Figure 3. Capacitance

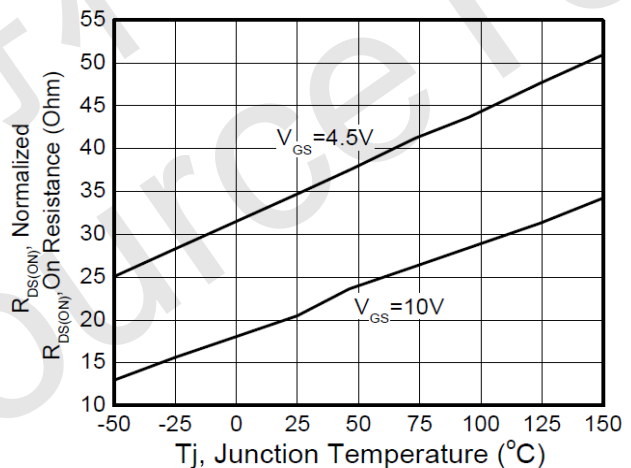

Figure 4. On Resistance Vs. Temperature

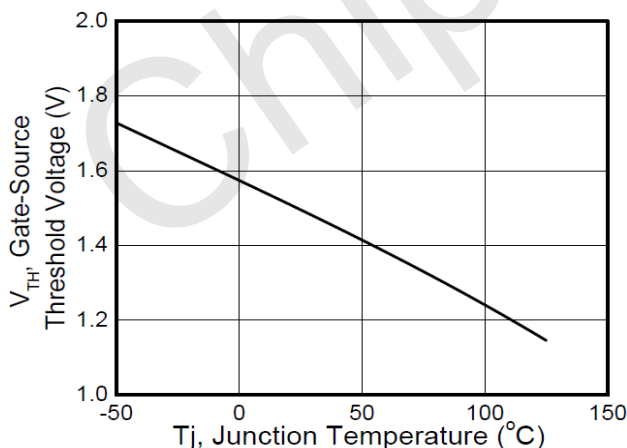

Figure 5. Gate Threshold Vs. Temperature

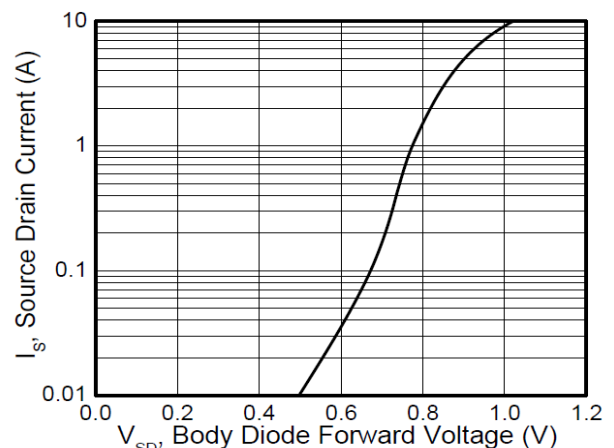

Figure 6. Body Diode Forward Voltage Vs. Source Current



■ **P Channel TYPICAL CHARACTERISTICS** (25°C Unless Note)

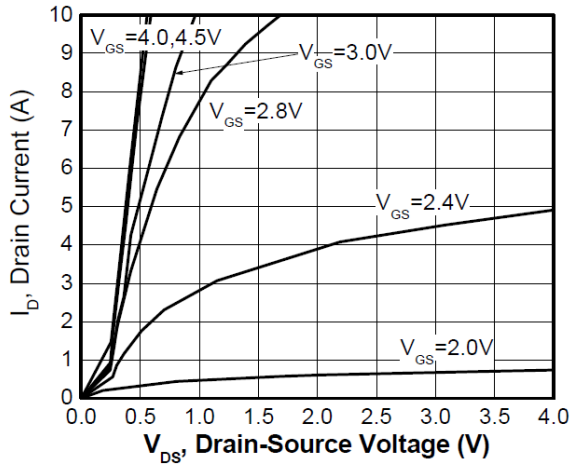

Figure 1. Output Characteristics

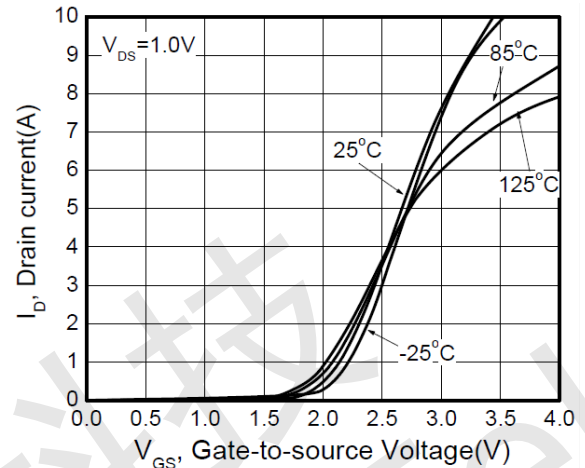

Figure 2. Transfer Characteristics

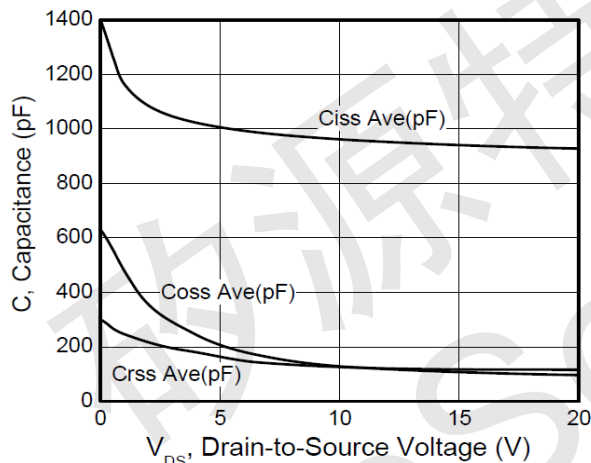

Figure 3. Capacitance

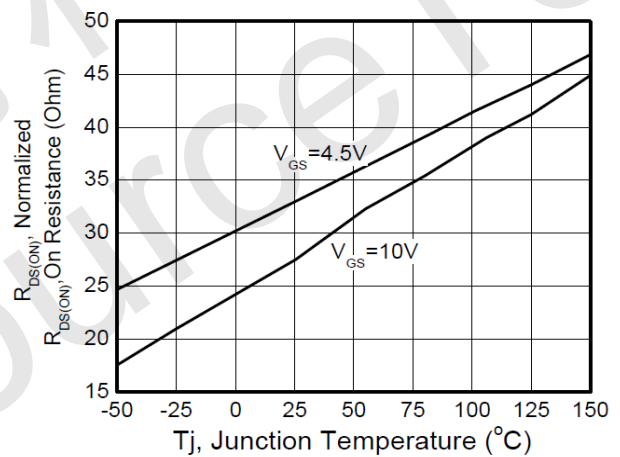

Figure 4. On Resistance Vs. Temperature

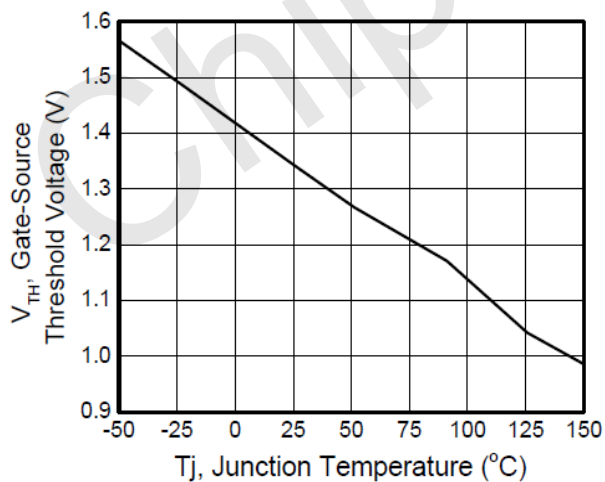

Figure 5. Gate Threshold Vs. Temperature

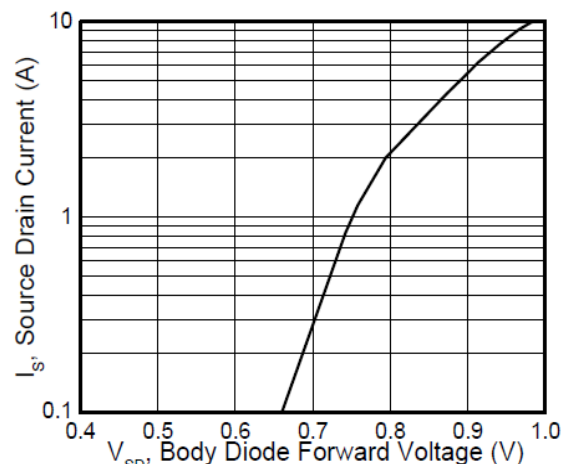
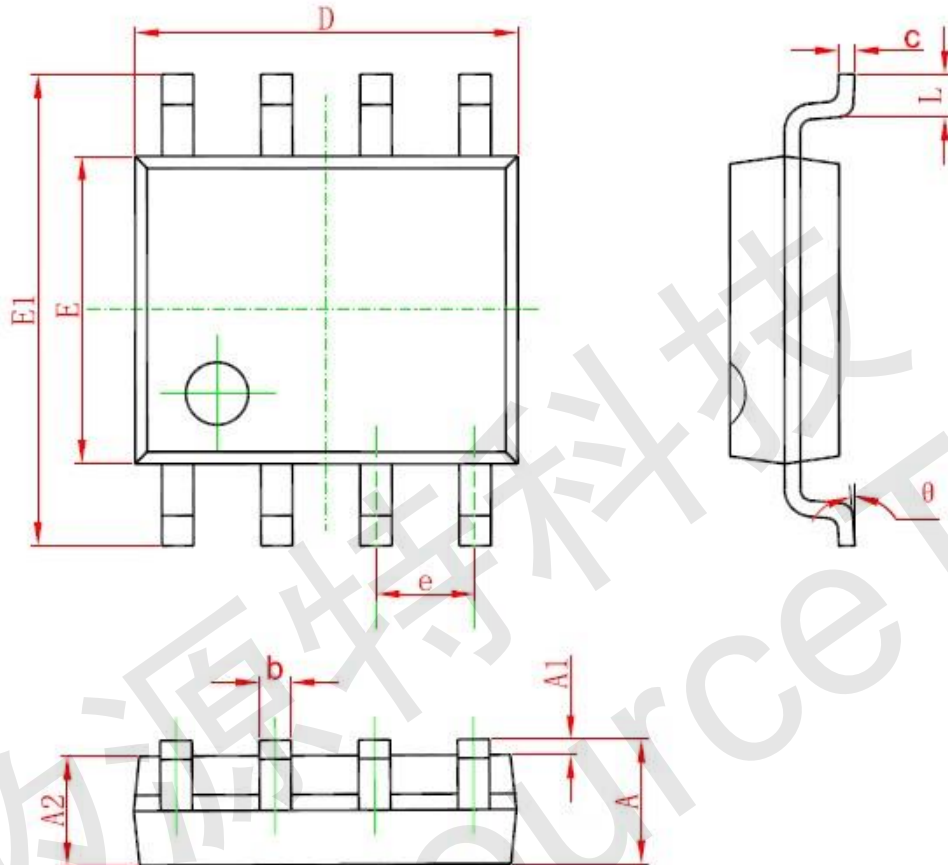

Figure 6. Body Diode Forward Voltage Vs. Source Current



■ SOP8 PACKAGE OUTLINE DIMENSIONS



Symbol	Dimensions In Millimeters		Dimensions In Inches	
	Min	Max	Min	Max
A	1.350	1.750	0.053	0.069
A1	0.100	0.250	0.004	0.010
A2	1.350	1.550	0.053	0.061
b	0.330	0.510	0.013	0.020
c	0.170	0.250	0.006	0.010
D	4.700	5.100	0.185	0.200
E	3.800	4.000	0.150	0.157
E1	5.800	6.200	0.228	0.244
e	1.270 (BSC)		0.050 (BSC)	
L	0.400	1.270	0.016	0.050
θ	0°	8°	0°	8°

UM4606 Rev B 28/July/2010

TEL: +86-0755-27595155 27595165

FAX: +86-0755-27594792

WEB: [Http://www.ChipSourceTek.com](http://www.ChipSourceTek.com)

E-mail: Tony.Wang@.ChipSourceTek.com InFo@ChipSourceTek.com



■ SOLDERING METHODS FOR UNIVERCHIP

Storage environment Temperature=10°C~35°C Humidity=65%±15%

Reflow soldering of surface mount device

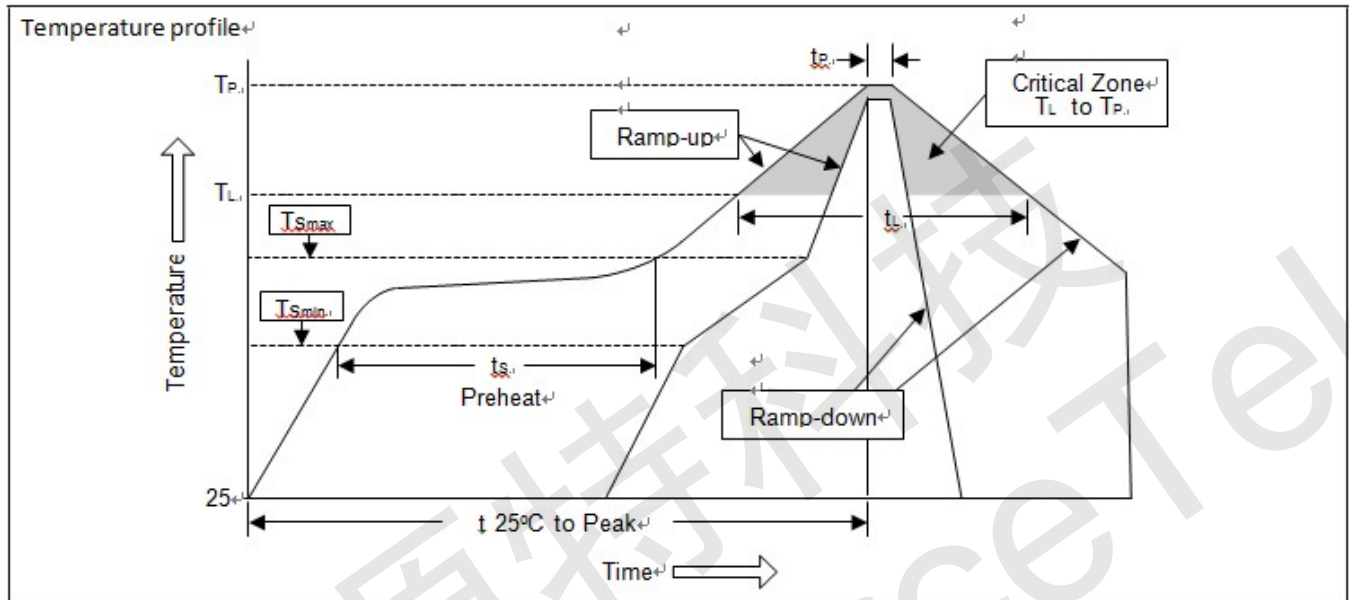

Profile Feature	Sn-Pb Eutectic Assembly	Pb free Assembly
Average ramp-up rate (T_L to T_P)	<3°C/sec	<3°C/sec
Preheat		
-Temperature Min (T_{Smin})	100°C	150°C
-Temperature Max (T_{Smax})	150°C	200°C
-Time (min to max) (t_s)	60~120 sec	60~180 sec
T_{Smax} to T_L		
-Ramp-up Rate	<3°C/sec	<3°C/sec
Time maintained above		
-Temperature (T_L)	183°C	217°C
-Time (t_L)	60~150 sec	60~150 sec
Peak Temperature (T_P)	240°C+0/-5°C	260°C+0/-5°C
Time within 5°C of actual Peak Temperature (t_p)	10~30 sec	20~40 sec
Ramp-down Rate	<6°C/sec	<6°C/sec
Time 25°C to Peak Temperature	<6 minutes	<6 minutes



深圳市矽源特科技有限公司

ShenZhen ChipSourceTek Technology Co. ,Ltd.



Flow (wave) soldering (solder dipping)

Product	Peak Temperature	Dipping Time
Pb device	245°C±5°C	5sec±1sec
Pb-Free device	260°C+0/-5°C	5sec±1sec



This integrated circuit can be damaged by ESD. UniverChip Corporation recommends that all integrated circuits be handled with appropriate precautions. Failure to observe proper handling and installation procedure can cause damage. ESD damage can range from subtle performance degradation to complete device failure. Precision integrated circuits may be more susceptible to damage because very small parametric changes could cause the device not to meet its published specifications.

矽源特科技
ChipSourceTek

UM4606 Rev B 28/July/2010

TEL: +86-0755-27595155 27595165

FAX: +86-0755-27594792

WEB: [Http://www.ChipSourceTek.com](http://www.ChipSourceTek.com)

E-mail: Tony.Wang@.ChipSourceTek.com InFo@ChipSourceTek.com